

AS-C74

ATX motherboard

User's Manual

Edition: 1.4

2014/05/13

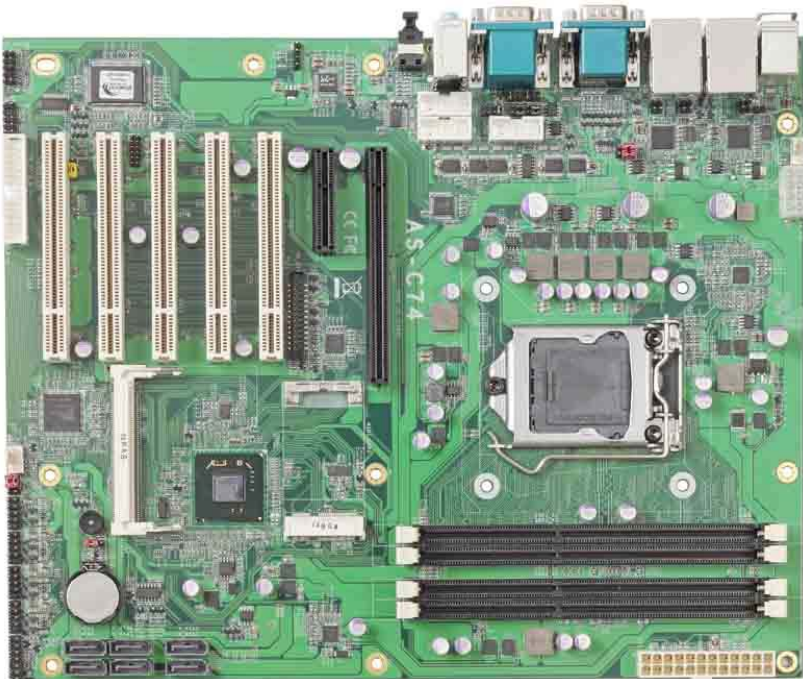

Copyright

Copyright 2011 All rights reserved. This document is copyrighted and all rights are reserved. The information in this document is subject to change without prior notice to make improvements to the products.

This document contains proprietary information and protected by copyright. No part of this document may be reproduced, copied, or translated in any form or any means without prior written permission of the manufacturer.

All trademarks and/or registered trademarks contains in this document are property of their respective owners.

Disclaimer

The company shall not be liable for any incidental or consequential damages resulting from the performance or use of this product.

The company does not issue a warranty of any kind, express or implied, including without limitation implied warranties of merchantability or fitness for a particular purpose.

The company has the right to revise the manual or include changes in the specifications of the product described within it at any time without notice and without obligation to notify any person of such revision or changes.

Trademark

All trademarks are the property of their respective holders.

Any questions please visit our website at <http://www.commell.com.tw>.

Packing List

Please check package component before you use our products.

Hardware:

AS-C74 ATX motherboard x 1

Cable Kit:



SATA Cable x 2
(OALSATA3-L)/ (1040529)

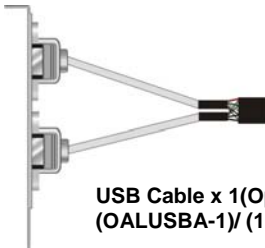

USB Cable x 1 (Option)
(OALUSBA-1)/ (1040172)

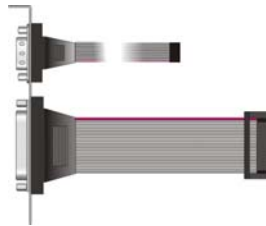

DB25 & DB9 cable x 1
(OAL1S1P)/ (1040041)



DVI module with bracket x 1
(BADPDVIP_A & OALDVI-P)/
(4120008021 & 1040075)

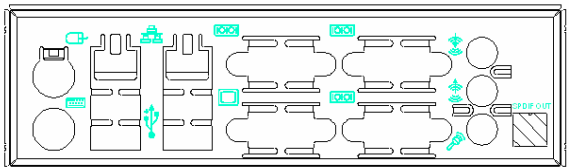

I/O Shield x 1
(OPLATE-C74)/ (1270049)

Other Accessories:

Drivers CD (including User's Manual) x 1

Index

Chapter1 <Introduction>	7
1.1 <Product Overview>	7
1.2 <Product Specification>	8
1.3 <Block Diagram>	10
1.4 <Mechanical Drawing >	11
Chapter 2 <Hardware Setup>	12
2.1 <Connector Location>.....	12
2.2 <Jumper Reference>	13
2.3 <Connector Reference>.....	14
2.3.1 <Internal Connectors>	14
2.3.2 <External Connectors>	14
2.4 <CPU and Memory Setup>	15
2.4.1 <CPU installation>.....	15
2.4.2 <Memory installation>.....	16
2.5 <CMOS Setup>.....	17
2.6 <Serial ATA installation>.....	18
2.7 <LAN installation>.....	19
2.8 <Onboard Display Interface>	20
2.8.1 <Analog Display>.....	20
2.8.2 <DVI Display >.....	21
2.9 <Audio Installation>	22
2.10 <GPIO and SMBUS interface>	24
2.11 <USB Installation>.....	25
2.12 <Power and Fan Installation>	27
2.13 <Serial Port>.....	29
2.14 <Switch and Indicator>	32
Chapter 3 <System Configuration>	34
3.1 <SATA configuration>.....	34

3.2 <SATA RAID Configuration>	35
3.3 <Audio Configuration>	37
3.4 <Display Properties Setting>.....	38
Chapter 4 <BIOS Setup>	40
Appendix A <I/O Port Pin Assignment>	42
A.1 <Serial ATA Port>.....	42
A.2 <IrDA Port>.....	42
A.3 <LAN Port>.....	42
A.4 <Serial Port>.....	43
A.5 <VGA Port>	43
A.6<Parallel Port>.....	44
Appedix B <System Resources>	45
B.1 <I/O Port Address Map>	45
B.2 <Memory Address Map>	47
B.3 <System IRQ Resources>	48
Appendix C <Programming GPIO's>	49
Appendix D <Watch Dog timer Setting >	50
Contact Information.....	51

(This Page is Left for Blank)

Chapter1 <Introduction>

1.1 <Product Overview>

AS-C74 is the motherboard with last Intel desktop technology with Mini-ITX form factor. Based on Intel® Q67, the board integrates I3/I5/I7/Pentium/Xeon® processor 1155-pin socket, DDR3 memory socket, Intel® HD Graphic technology, Serial ATA II with RAID function for a powerful desktop system.

Intel® FCLGA1155 processor

The Intel® I3/I5/I7/Pentium/Xeon® processor now comes with a new form factor with 1155-pin FCLGA package, for 1066/1333MHz front-side-bus, 12MB L2 cache, for 65nm and 45nm manufacturing technology, the PLGA processor without pin header on solder side can make user installing the processor on the socket easier.

Intel® Q67 PCH chipset

The Intel Q67 integrates DDR3 1066/1333MHz for memory, and HD Graphic technology for new graphic engine. The Q67 integrates with up to 12 USB2.0 interfaces, and serial ATA II interface with RAID function.

Flexible Extension Interface

The board provides one mini-PCIE socket, one mini-PCI socket, five PCI slots, one PCIE X4 and one PCIE X16 slot.

1.2 <Product Specification>

General Specification

Form Factor	ATX motherboard
CPU	Intel® I3/I5/I7/Pentium/Xeon® processor With LGA1155 socket Package type: FCLGA 1155
Memory	4 x 240-pin DDR3 1066/1333MHz SDRAM up to 32GB Unbuffered, none-ECC memory supported only
Chipset	Intel® BD82Q67 PCH
BIOS	Phoenix 16Mb SPI flash BIOS
Green Function	Power saving mode includes doze, standby and suspend modes. ACPI version 1.0 and APM version 1.2 compliant
Watchdog Timer	System reset programmable watchdog timer with 1 ~ 255 sec./min. of timeout value
Real Time Clock	Chipset built-in RTC with lithium battery
Serial ATAll	Intel® Q67 PCH integrates 4 Serial ATA II interface& 2 Serial ATA III RAID 0, 1,5,10 Intel Matrix Storage Technology supported

Multi-I/O Port

Chipset	Intel® Q67 PCH with Winbond® W83627DHG-P Controller
Serial Port	Five RS-232 and one RS232/422/485 serial ports
USB Port	Twelve Hi-Speed USB 2.0 ports with 480Mbps of transfer rate
IrDA Port	One IrDA compliant Infrared interface supports SIR
K/B & Mouse	External PS/2 keyboard and mouse ports on rear I/O panel
GPIO	One 12-pin Digital I/O connector with 8-bit programmable I/O Interface
Smart Fan	One CPU fan connectors for fan speed controllable

VGA Display Interface

Chipset	Intel® Clear Video integrated HD Graphics Technology
Frame Buffer	Up to 1.7GB shared with system memory
Display Type	CRT, LCD monitor with analog display Onboard DVI interface
Connector	External DB15 female connector on rear I/O panel Onboard 26-pin DVI Connector

Ethernet Interface

Controller	Two Intel 82574L Gigabit Ethernet controller
Type	Triple speed 10/100/1000Base-T Auto-switching Fast Ethernet Full duplex, IEEE802.3U compliant
Connector	Two External RJ45 connectors with LED on rear I/O panel

Audio Interface

Chipset	Intel® integrated Q67with Realtek ALC888HD Audio Intel High Definition Audio compliance
Interface	2 channels sound output
Connector	External 3 phone jack for 2 channel audio on rear I/O panel External SPDIF connector on rear I/O panel Internal 10-pin header for line-out, MIC-in, 4-pin header for CD-IN

Power and Environment

Power Requirement	Standard ATX 24-pin (20-pin is compatible) power supply Additional +12V 8-pin power connector (4-pin is compatible)
Dimension	307(L) x 244 (H) mm
Temperature	Operating within 0 ~ 60°C (32 ~ 140°F) Storage within -20 ~ 85°C (-4 ~ 185°F)

Ordering Code

AS-C74	Onboard VGA, DVI, 2 x Gigabit LAN, 12 x USB2.0, 6 x serial Port, 6 x SATA, 1 x IrDA, Realtek HD 5.1CH Audio, Mini-PCI, PCI, PCIE Mini card, PCIE x16& PCIE x4.
---------------	--

The specifications may be different as the actual production.

1.3 <Block Diagram>

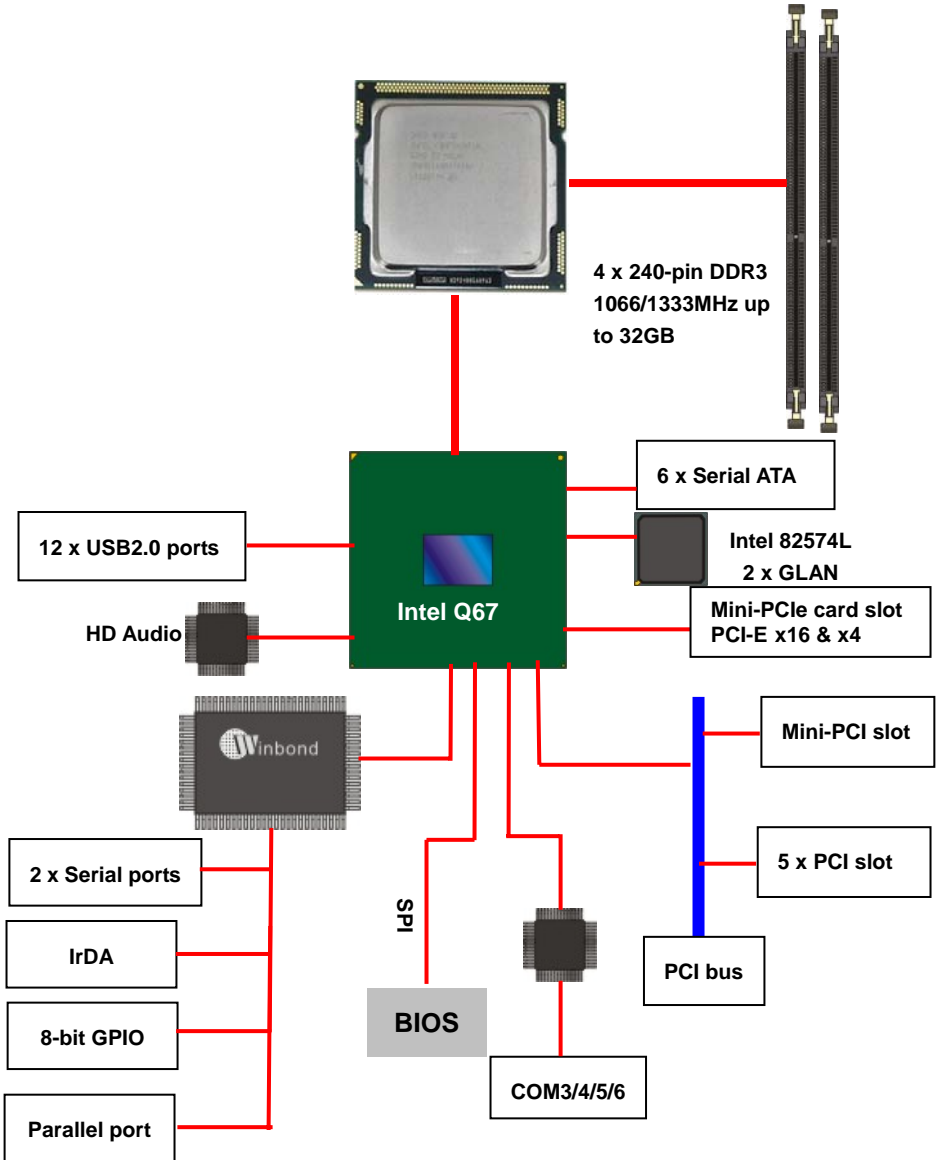

1.4 <Mechanical Drawing >

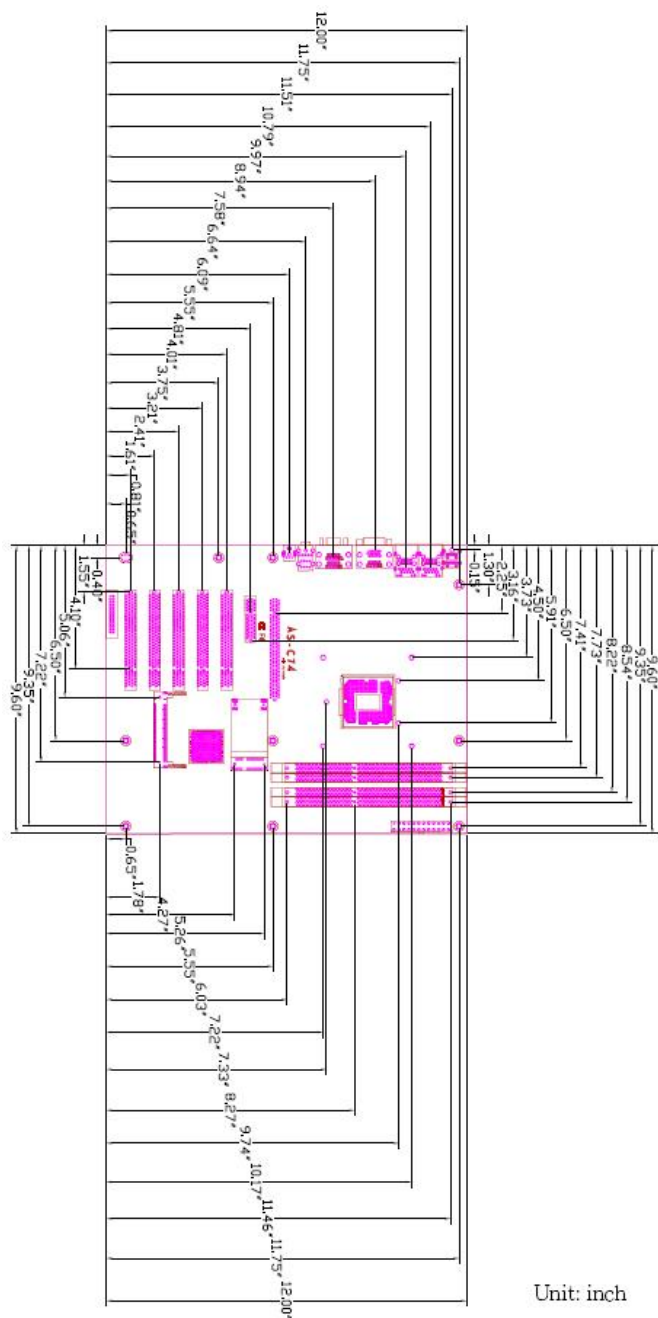

Unit: inch

Chapter 2 <Hardware Setup>

2.1 <Connector Location>

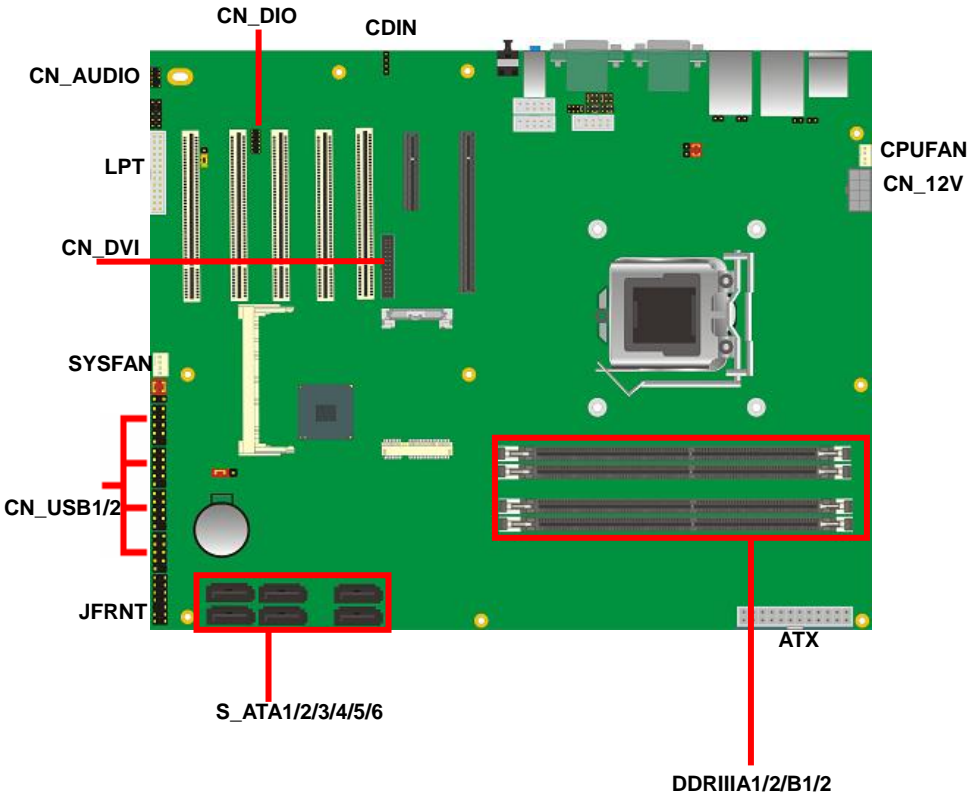

2.2 <Jumper Reference>

Jumper	Function
JRTC	CMOS Operating/Clear Setting
JP1	COM1 signal mode switch (For Pin-1 & Pin-9)
JP2	COM2 signal mode switch (For Pin-1 & Pin-9)
JAT	Power mode select
JCSEL1	CN_COM2 RS-232 RS422 RS485 Setting
JCSEL2	CN_IR IrDA Setting
JVUSB1/2	USB Voltage Setting

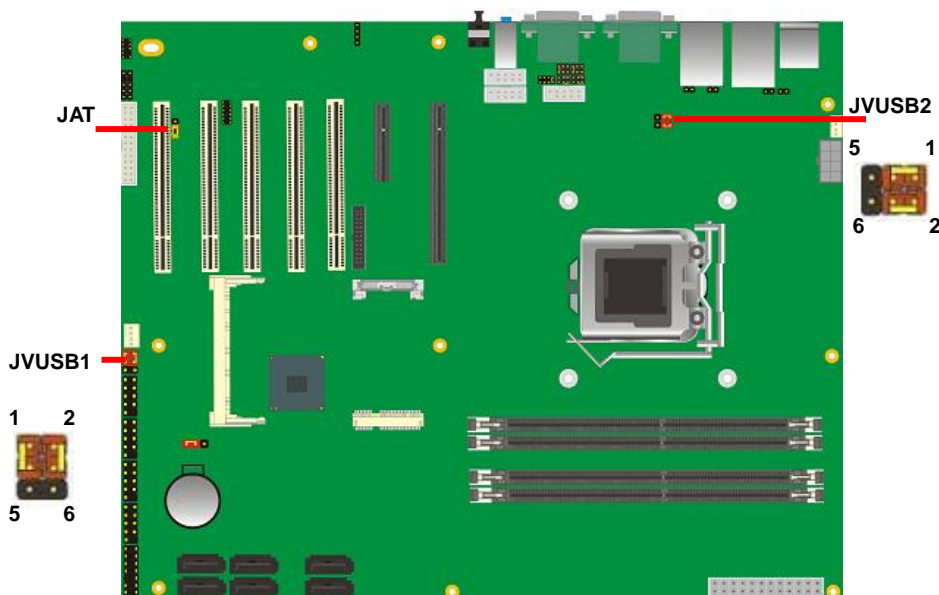

Jumper: **JAT**

Type: Onboard 3-pin jumper

JAT	Mode
1-2	AT Power mode
2-3	ATX Power mode
Default setting	

Jumper: **JVUSB1/2**

Type: Onboard 6-pin jumper

JVUSB	Mode
1-3 & 2-4	5V
3-5 & 4-6	5V_SB
Default: 1-3 & 2-4	



2.3 <Connector Reference>

2.3.1 <Internal Connectors>

Connector	Function	Remark
CPU	LGA1155 CPU socket	
DDRIIA1/2&B1/2	240 –pin DDR3 SDRAM DIMM socket	
S_ATA1/2/3/4/5/6	7-pin Serial ATA II connector	
ATX	24-pin power supply connector	
CN_12V	8-pin +12V additional power supply connector	
CN_AUDIO	5 x 2-pin audio connector	
CDIN	4-pin CD-ROM audio input connector	
CN_DIO	6 x 2-pin digital I/O connector	
CN_USB1/2/3/4	10-pin USB connector	
CPUFAN	4-pin CPU cooler fan connector	
SYSFAN	3-pin system cooler fan connector	
CN_IR	5-pin IrDA connector	
CN_SMBUS	5-pin SMBUS connector	
JFRNT	14-pin front panel switch/indicator connector	
PCIE_16X	PCI Express 16x slot	
PCIE_4X	PCI Express 4x slot	
Mini-PCI	1 x Mini-PCI socket	
PCI	5 x PCI slots	
CN_DVI	26 Pin connector	
CN_COM4/5/6	5 x 2-pin com connector	
MINI_CARD	1 x 52-pin PCI Express mini card	
LPT	26-pin LPT port connector	

2.3.2 <External Connectors>

Connector	Function	Remark
PS2	PS/2 Keyboard/Mouse connector	
CRT+COM1	DB15 VGA + Serial port connector	
USB_RJ45_1/2	Dual USB and one RJ45 LAN Port	
COM 2/3	Serial port connector	
AUDIO	Audio connectors	
SPDIF	SPDIF digital audio output connector	

2.4 <CPU and Memory Setup>

2.4.1 <CPU installation>

AS-C74 has a LGA1155 CPU socket onboard; please check following steps to install the processor properly.

Attention If AS-C74 need RMA please Keep CPU socket cover on the CPU Socket.

Warning If CPU Socket internal Pin damage We could not provide warranty.



Intel® I3/I5/I7/Pentium® processor
Package type: 1155 pin FCLGA
FSB:1066/1333MHz

1. Lift this bar

Checked point

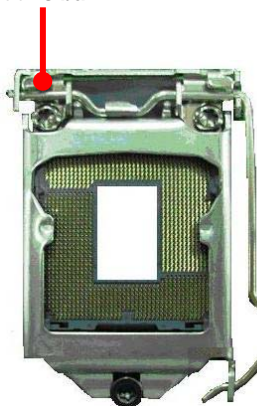

2. Uncover this plate

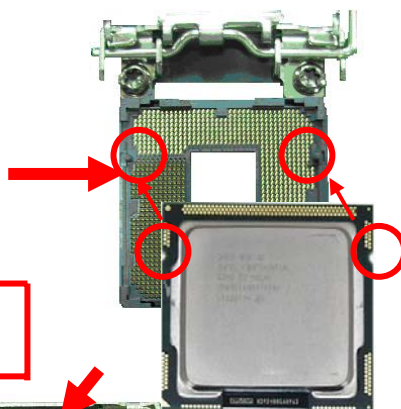

3. Place the CPU on the top of the pins

4. Lock this bar

3. Cover this plate

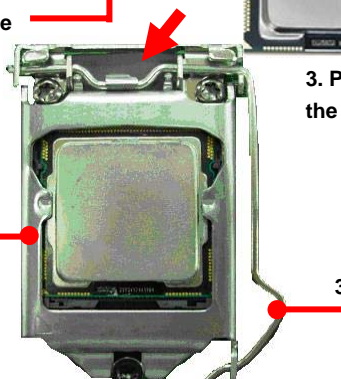

Notice: Please place the CPU on the pins tenderly to avoid bending the pins

2.4.2 <Memory installation>

AS-C74 has four 240-pin DDR3 DIMM support up to 32GB of memory capacity. The memory frequency supports 1066/1333 MHz. Only Non-ECC memory is supported.

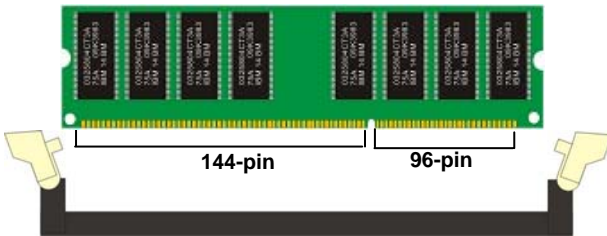
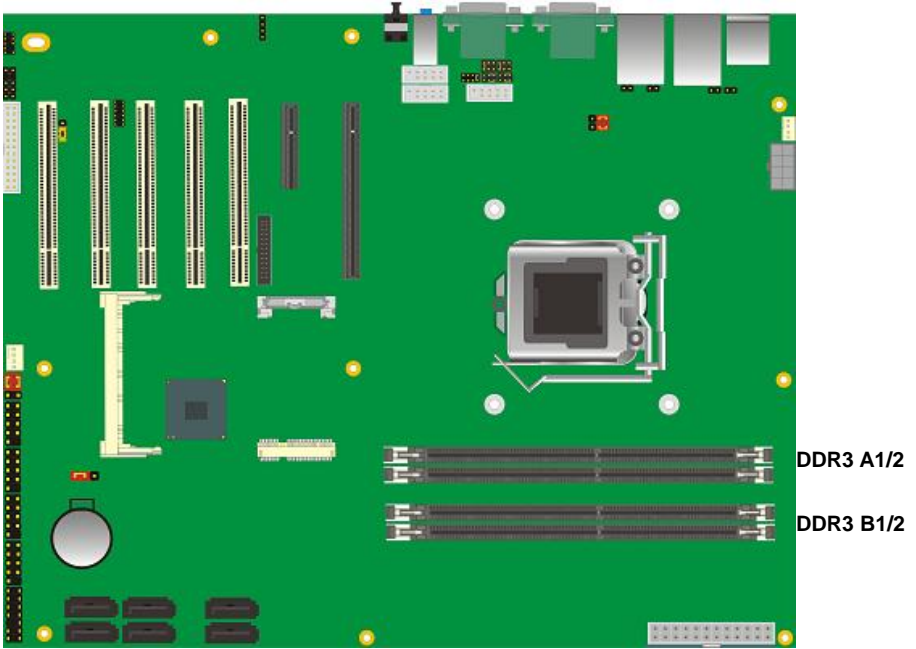

Please check the pin number to match the socket side well before installing memory module.

2.5 <CMOS Setup>

The board's data of CMOS can be setting in BIOS. If the board refuses to boot due to inappropriate CMOS settings, here is how to proceed to clear (reset) the CMOS to its default values.

Jumper: JRTC

Type: Onboard 3-pin jumper

JRTC	Mode
1-2	Clear CMOS
2-3	Normal Operation

Default setting

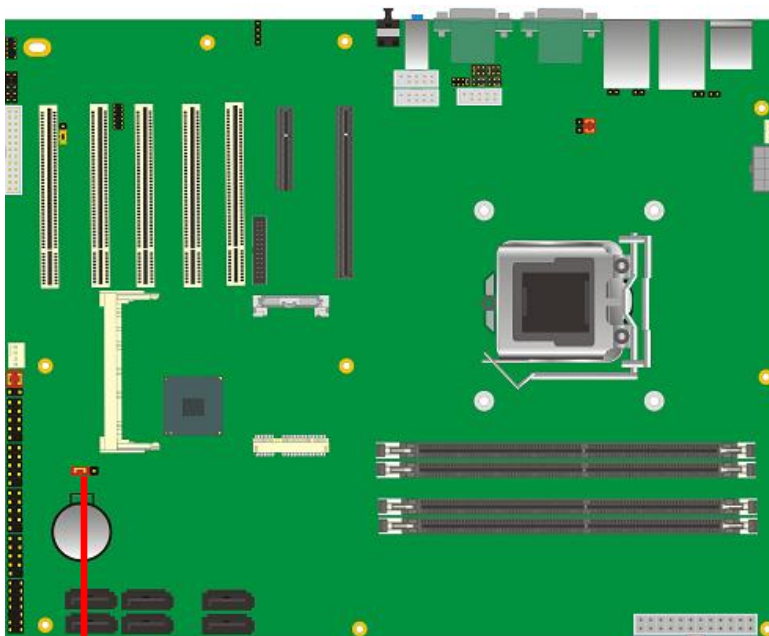

3 1
 JRTC

2.6 <Serial ATA installation>

AS-C74 has Four Serial ATA II & Two Serial ATA III interfaces with RAID function, the transfer rate of the Serial ATA II can be up to 300MB/s & Serial ATA III can be up to 600MB/s.

Please go to <http://www.serialata.org/> for more about Serial ATA technology information.

Based on Intel® PCH, it supports **Intel® Matrix Storage Technology** with combination of RAID 0,1,5 and 10. The main features of RAID on Intel® Q67 PCH are listed below:

1. Supports for up to RAID volumes on a single, two-hard drive RAID array.
2. Supports for two, two-hard drive RAID arrays on any of six Serial ATA ports.
3. Supports for Serial ATA ATAPI devices.
4. Supports for RAID spares and automatic rebuild.
5. Supports on RAID arrays, including NCQ and native hot plug.

For more information please visit Intel's official website.

For more about the system setup for Serial ATA, please check the chapter of SATA configuration.

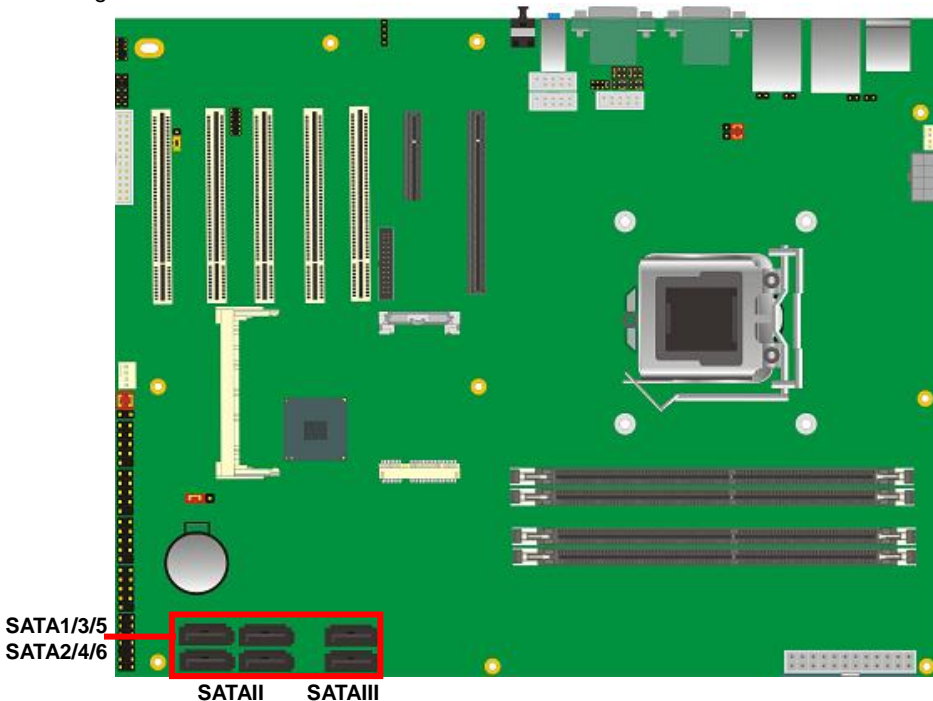

2.7 <LAN installation>

The board integrates with two Intel 82574L Gigabit Ethernet controllers, as the PCI Express bus. The Intel 82574L supports triple speed of 10/100/1000Base-T, with IEEE802.3 compliance and Wake-On-LAN supported.



2.8 <Onboard Display Interface>

Based on Intel Q67 chipset with built-in graphics, the board provides one DB15 Connector on rear external I/O port and the board also provides 26-pin DVI interface

Notice: When you install any PCI Graphic card, the onboard graphics would be disabled automatically.

2.8.1 <Analog Display>

Please connect your CRT or LCD monitor with DB15 male connector to the onboard DB15 female connector on rear I/O port.



2.8.2 <DVI Display >

The board also comes with a DVI interface with Chronitel for digital video interface.

Connector: **CN_DVI**

Connector type: 26-pin header connector (pitch = 2.00mm)

Pin Number	Assignment	Pin Number	Assignment
1	TX1+	2	TX1-
3	Ground	4	Ground
5	TXC+	6	TXC-
7	Ground	8	PVDD
9	N/C	10	N/C
11	TX2+	12	TX2-
13	Ground	14	Ground
15	TX0+	16	TX0-
17	N/C	18	HPDET
19	DDCDATA	20	DDCCLK
21	GND	22	N/C
23	N/C	24	N/C
25	N/C	26	N/C

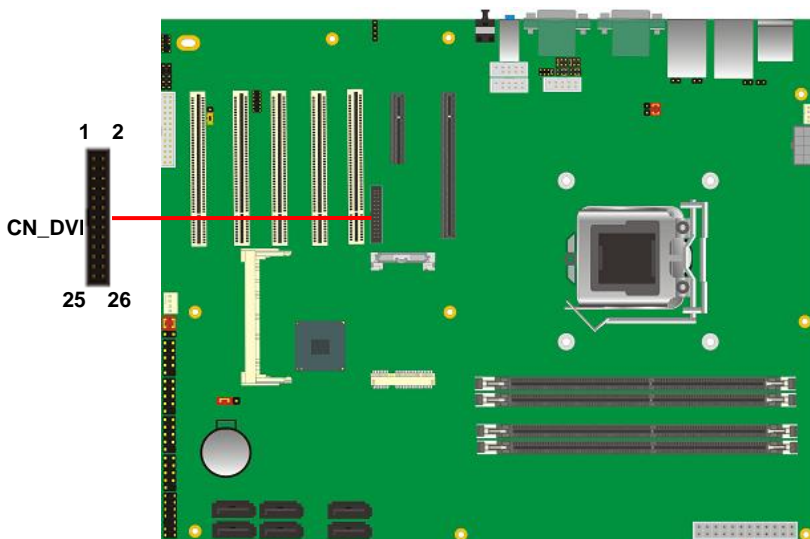

2.9 <Audio Installation>

The board integrates onboard audio interface with REALTEK ALC888 codec, with Intel next generation of audio standard as High Definition Audio, it offers more vivid sound and other advantages than former HD audio compliance.

The main specifications of ALC888 are:

- High-performance DACs with 100dB S/N ratio
- 2 DAC channels support 16/20/24-bit PCM format for 2 audio solution
- 16/20/24-bit S/PDIF-OUT supports 44.1K/48K/96kHz sample rate
- Compatible with HD
- Meets Microsoft WHQL/WLP 2.0 audio requirements

The board provides 2 channels audio phone jacks on rear I/O port, Line-in/MIC-in ports for front I/O panel through optional cable.

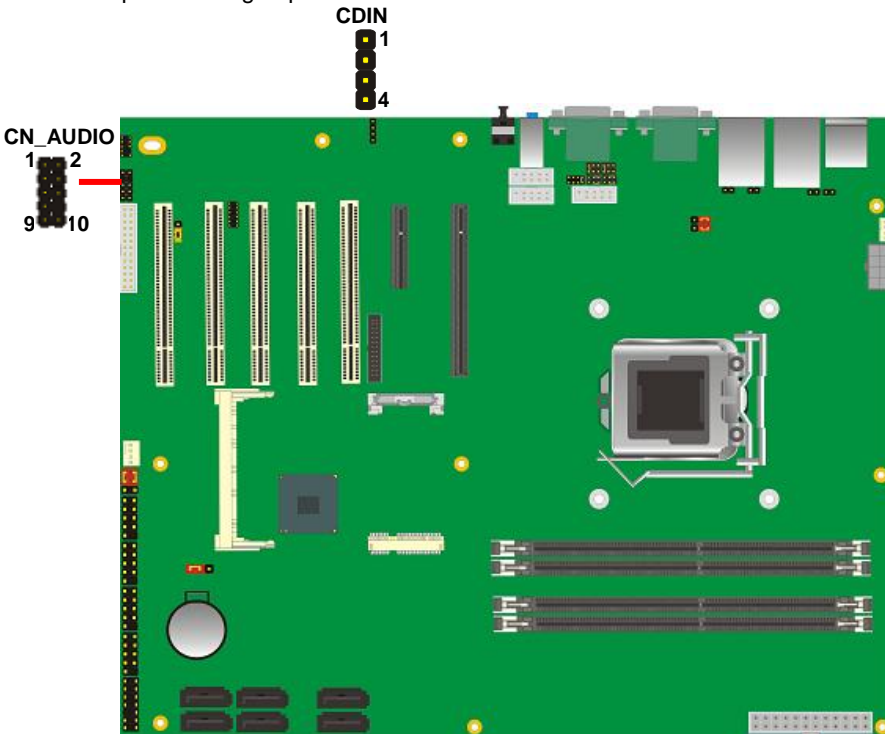

Connector: CN_AUDIO

Type: 10-pin (2 x 5) header (pitch = 2.54mm)

Pin	Description	Pin	Description
1	MIC_L	2	Ground
3	MIC_R	4	ACZ_DET
5	Speaker_R	6	MIC Detect
7	SENSE	8	N/C
9	Speaker_L	10	Speaker Detect

Connector: CDIN

Type: 4-pin header (pitch = 2.54mm)

Pin	Description
1	CD – Left
2	Ground
3	Ground
4	CD – Right

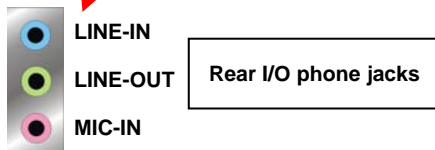

2.10 <GPIO and SMBUS interface>

The board provides a programmable 8-bit digital I/O interface, and a SMBUS (System management bus) interface for control panel application.

Connector: **CN_DIO**

Type: onboard 2 x 6-pin header, pitch=2.0mm

Pin	Description	Pin	Description
1	Ground	2	Ground
3	GP10	4	GP14
5	GP11	6	GP15
7	GP12	8	GP16
9	GP13	10	GP17
11	VCC	12	+12V

CN_SMBUS

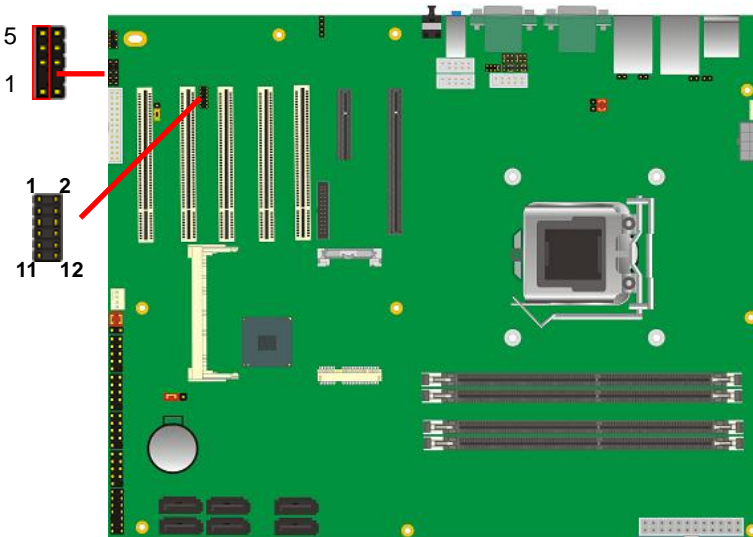

Connector: **CN_SMBUS**

Type: 5-pin header for SMBUS Ports

Pin	Description
1	VCC
2	N/C
3	SMBDATA
4	SMBCLK
5	Ground

2.11 <USB Installation>

AS-C74 integrates eight USB2.0 ports. The specifications of USB2.0 are listed below:

Interface	USB2.0
Controller	Intel Q67 PCH
Transfer Rate	Up to 480Mb/s
Voltage	5V

The Intel® Q67 contains two Enhanced Host Controller Interface (EHCI) and five Universal Host Controller Interfaces (UHCI), it can determine whether your connected device is for USB1.1 or USB2.0, and change the transfer rate automatically.



Connector: **CN_USB1/2**

Type: 10-pin (5 x 2) header for USB5/6 Ports

Pin	Description	Pin	Description
1	VCC	2	VCC
3	Data0-	4	Data1-
5	Data0+	6	Data1+
7	Ground	8	Ground
9	Ground	10	N/C

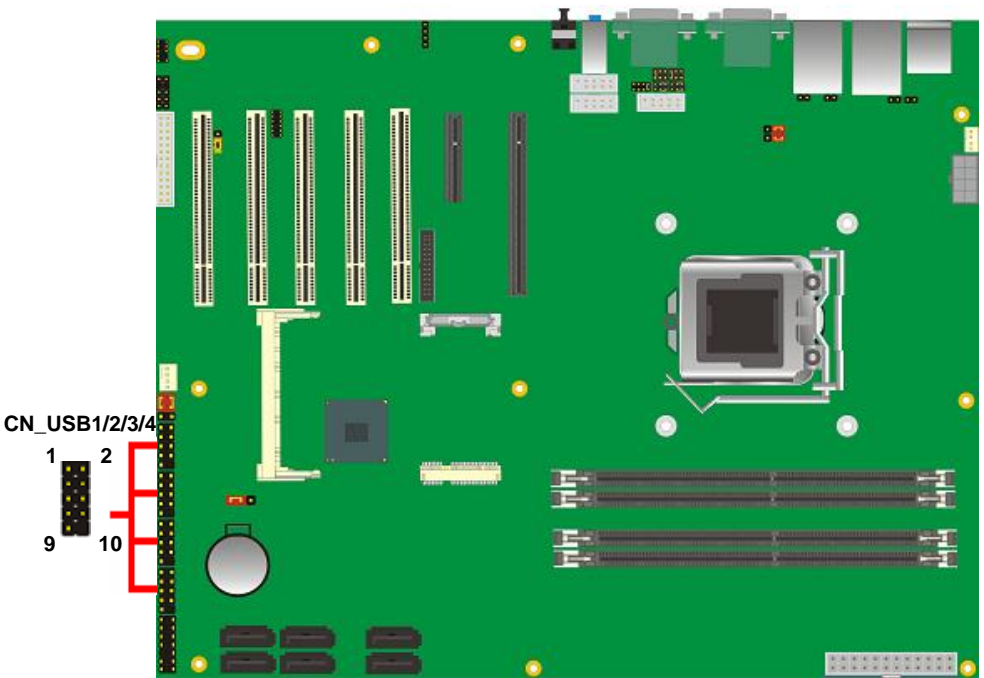

2.12 <Power and Fan Installation>

The AS-C74 provides a standard ATX power supply with **24-pin** ATX connector and additional 12V connector, and the board provides one **4-pin** fan connectors supporting smart fan for CPU cooler and one 3-pin cooler fan connectors for system and Northbridge chip. The 8-pin CN_12V additional power connector is necessary for CPU powering; please connect this well before you finishing the system setup.

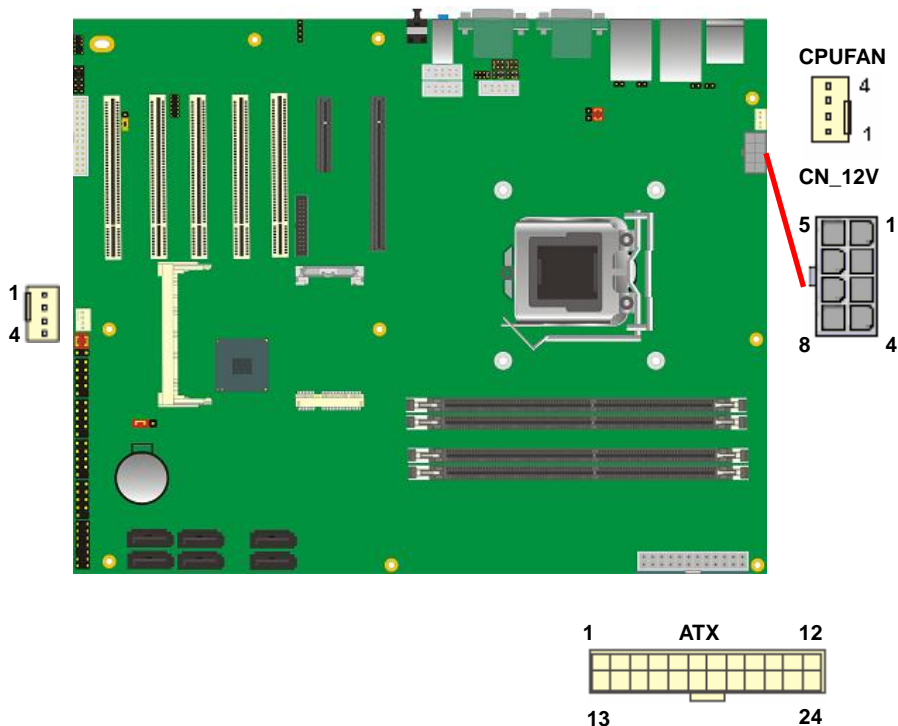

Connector: **ATX**

Type: 24-pin ATX power connector

PIN assignment			
1	3.3V	13	3.3V
2	3.3V	14	-12V
3	GND	15	GND
4	5V	16	PS_ON
5	GND	17	GND
6	5V	18	GND
7	GND	19	GND
8	PW_OK	20	-5V
9	5V_SB	21	5V
10	12V	22	5V
11	12V	23	5V
12	3.3V	24	GND

Connector: **CN_12V**

Type: 8-pin standard Pentium 4 additional +12V power connector

Pin	Description	Pin	Description
1	Ground	5	+12V
2	Ground	6	+12V
3	Ground	7	+12V
4	Ground	8	+12V

Connector: **CPUFAN**

Type: 4-pin fan wafer connector

Pin	Description	Pin	Description
1	Ground	2	+12V
3	Fan Speed Detection	4	Fan Control

Connector: **SYSFAN**

Type: 4-pin fan wafer connector

Pin	Description	Pin	Description
1	Ground	2	+12V
3	Fan Speed Detection	4	Fan Control

2.13 <Serial Port>

The board supports Three RS232 serial port and one jumper selectable RS232/422/485 serial ports. The jumper JCSEL1 & JCSEL2 can let you configure the communicating modes for COM2.







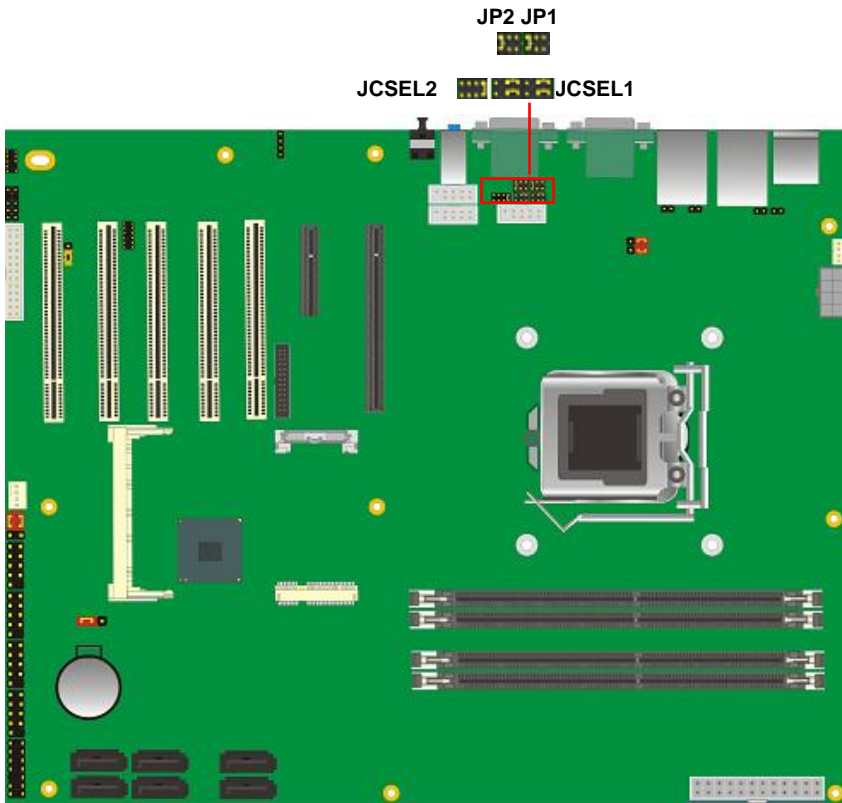

Connector: **COM2**

Type: 9-pin header connector for COM2

Pin	Description	Pin	Description
1	DCD/422TX-/485-	2	RXD/422TX+/485+
3	TXD/422RX+	4	DTR/422RX-
5	GND	6	DSR
7	RTS	8	CTS
9	RI	10	N/C

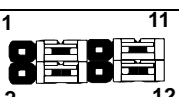

Function	JCSEL2	JCSEL1
SIR		
RS-422		
RS-485		
RS-232		

Default setting:

JCSEL2: (1-2) JCSEL1: (1-3, 2-4, 7-9, 8-10)

Jumper: JP1 (COM 1)/ JP2(COM2)

Type: onboard 3 x 2-pin header

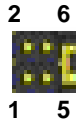

JP1/JP2	Mode
5-6	Standard COM Port
3-4	Pin9 with 12V signal
1-2	Pin9 with 5V signal

Default setting

2.14 <Switch and Indicator>

The JFRNT provides front control panel of the board, such as power button, reset and beeper, etc. Please check well before you connecting the cables on the chassis.

Connector: **JFRNT**

Type: onboard 14-pin (2 x 7) 2.54-pitch header

Function	Signal	PIN		Signal	Function
IDE LED	HDLED+	1	2	PWDLED+	Power LED
	HDLED-	3	4	N/C	
Reset	Reset+	5	6	PWDLED-	Speaker
	Reset-	7	8	SPKIN+	
N/C		9	10	N/C	
Power Button	PWRBT+	11	12	N/C	
	PWRBT-	13	14	SPKIN-	

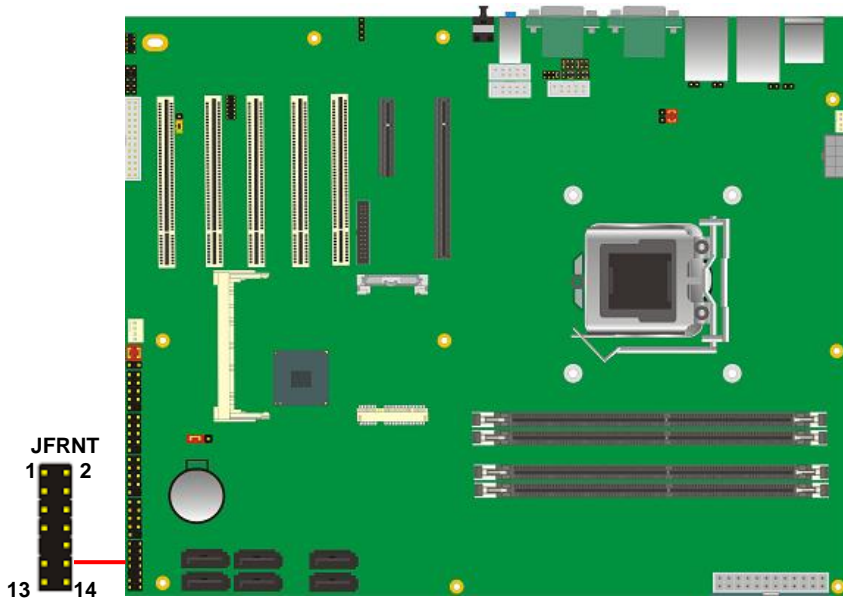

(This Page is Left for Blank)

Chapter 3 <System Configuration>

3.1 <SATA configuration>

SATA Mode:

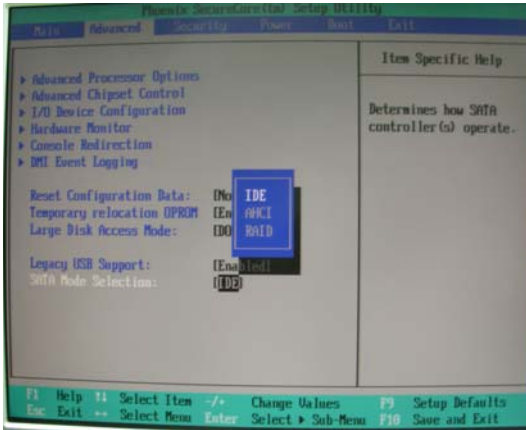

This option can let you select whether the Serial ATA hard drives would work under normal IDE mode or RAID mode. The RAID mode need more than one HDD is applied.

3.2 <SATA RAID Configuration>

The board integrates Intel® Q67 PCH with RAID function for Serial ATA II drives, and supports the configurations below:

RAID 0 (Striping): Two hard drives operating as one drive for optimized data R/W performance. It needs two unused drives to build this operation.

RAID 1 (Mirroring): Copies the data from first drive to second drive for data security, and if one drive fails, the system would access the applications to the workable drive. It needs two unused drives or one used and one unused drive to build this operation. The second drive must be the same or larger size than first one.

RAID 5 (striping with parity)

A RAID 5 array contains three or more hard drives where the data is divided into manageable blocks called strips. Parity is a mathematical method for recreating data that was lost from a single drive, which increases fault-tolerance. The data and parity are striped across all the hard drives in the array. The parity is striped in a rotating sequence to reduce bottlenecks associated with the parity calculations.

RAID 10 (RAID 0+1)

A RAID 10 array uses four hard drives to create a combination of RAID levels 0 and 1. The data is striped across a two-drive array forming the RAID 0 component. Each of the drives in the RAID 0 array is then mirrored by a RAID 1 component.

Intel Matrix Storage Technology: This technology would allow you to use **RAID 0+1** mode on only two drives (4 drives needed on traditional RAID 0+1). It will create two partitions on each hard drive to simulate **RAID 0** and **RAID 1**. It also can let you modify the partition size without re-formatted.

For more information of Intel Matrix Storage Technology, please visit Intel's website.

If you need to install an operation system on the RAID set, please use the driver disk attached in the package when it informs you to obtain the RAID drivers.

3.3 <Audio Configuration>

The board integrates Intel® Q67 PCH with REALTEK® ALC888 codec. It can support 2-channel sound under system configuration. Please follow the steps below to setup your sound system.

1. Install REALTEK HD Audio driver.

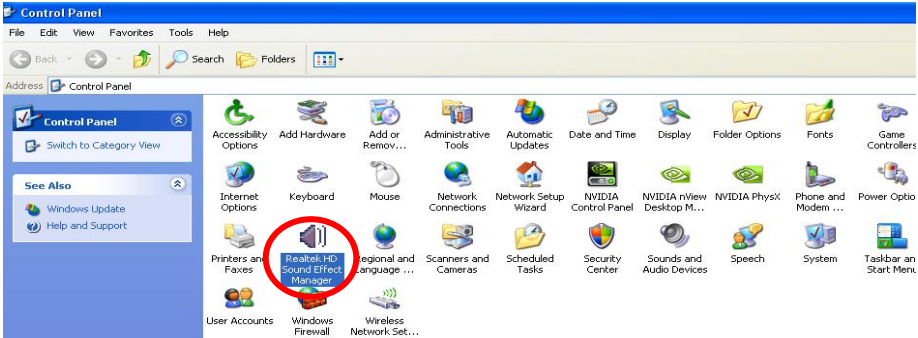

2. Launch the control panel and Sound Effect Manager.
3. Select Speaker Configuration



4. Select the sound mode to meet your speaker system.

3.4 <Display Properties Setting>

Based on Intel Q67 with HD Graphic, the board supports two DACs for display device as different resolution and color bit.

Please install the Intel Graphic Driver before you starting setup display devices.

1. Click right button on the desktop to lunch **display properties**

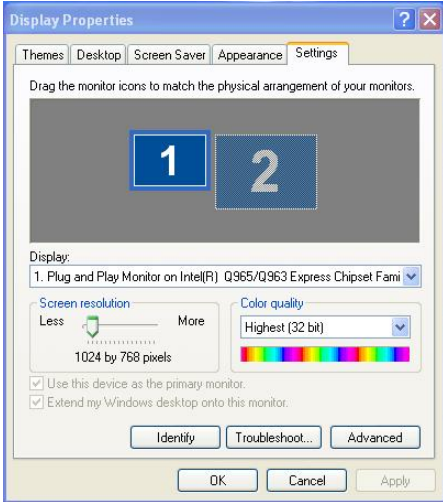

2. Click **Advanced** button for more specificity setup.

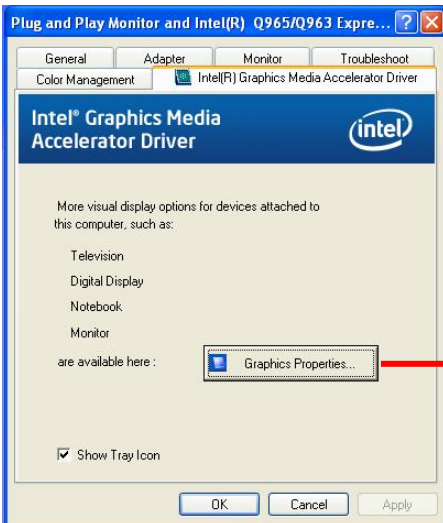

Click Graphics Properties... for advanced setup

4. This setup options can let you define each device settings.

Click **Monitor** to setup the CRT monitor for Colors, Resolution and Refresh Rate

Click **Intel® Dual Display Clone** to setup the dual display mode as same screen



Chapter 4 <BIOS Setup>

The motherboard uses the Phoenix BIOS for the system configuration. The Phoenix BIOS in the single board computer is a customized version of the industrial standard BIOS for IBM PC AT-compatible computers. It supports Intel x86 and compatible CPU architecture based processors and computers. The BIOS provides critical low-level support for the system central processing, memory and I/O sub-systems.

The BIOS setup program of the single board computer let the customers modify the basic configuration setting. The settings are stored in a dedicated battery-backed memory, NVRAM, retains the information when the power is turned off. If the battery runs out of the power, then the settings of BIOS will come back to the default setting.

The BIOS section of the manual is subject to change without notice and is provided here for reference purpose only. The settings and configurations of the BIOS are current at the time of print, and therefore they may not be exactly the same as that displayed on your screen.

To activate CMOS Setup program, press key immediately after you turn on the system. The following message "Press DEL to enter SETUP" should appear in the lower left hand corner of your screen. When you enter the CMOS Setup Utility, the Main Menu will be displayed as **Figure 4-1**. You can use arrow keys to select your function, press <Enter> key to accept the selection and enter the sub-menu.

Figure 4-1 CMOS Setup Utility Main Screen

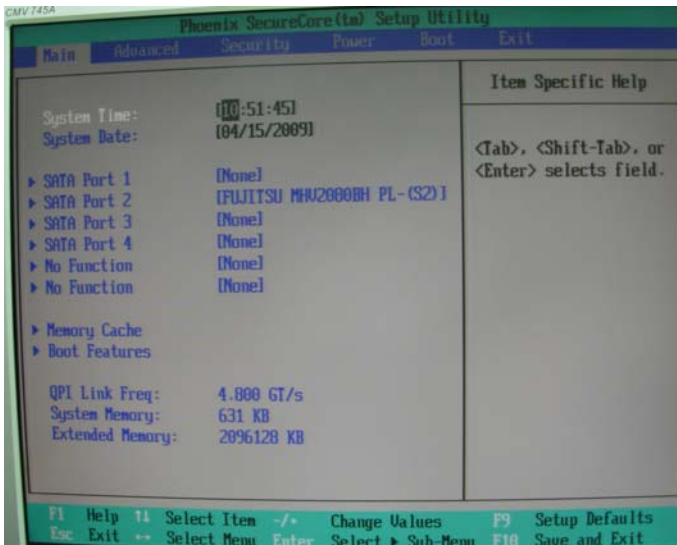

(This Page is Left for Blank)

Appendix A <I/O Port Pin Assignment>

A.1 <Serial ATA Port>

Connector: **S_ATA1/2/3/4/5/6**

Type: 7-pin wafer connector

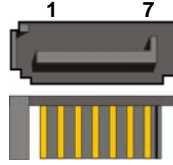

1	2	3	4	5	6	7
GND	RSATA_TXP1	RSATA_TXN1	GND	RSATA_RXN1	RSATA_RXP1	GND

A.2 <IrDA Port>

Connector: **CN_IR**

Type: 5-pin header for SIR Ports

Pin	Description
1	VCC
2	N/C
3	IRRX
4	Ground
5	IRTX



A.3 <LAN Port>

Connector: **RJ45/2**

Type: RJ45 connector with LED on bracket



Pin	1	2	3	4	5
Description	TRD0+	TRD0-	TRD1+	TRD2+	TRD2-

Pin	6	7	8	9	10
Description	TRD1-	TRD3+	TRD3-	NC	NC

A.4 <Serial Port>

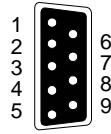

Connector: **COM1/2/3**

Type: 9-pin D-sub male connector on bracket

Pin	Description	Pin	Description
1	DCD	6	DSR
2	SIN	7	RTS
3	SO	8	CTS
4	DTR	9	RI
5	Ground		

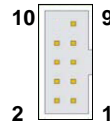

Connector: **CN_COM4/5/6**

Type: 9-pin D-sub male connector on bracket

Pin	Description	Pin	Description
1	DCD	6	DSR
2	SIN	7	RTS
3	SO	8	CTS
4	DTR	9	RI
5	Ground		

A.5 <VGA Port>

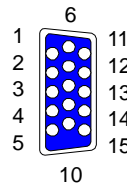

Connector: **CRT**

Type: 15-pin D-sub female connector on bracket

Pin	Description	Pin	Description	Pin	Description
1	RED	6	Ground	11	N/C
2	GREEN	7	Ground	12	DDC_DA
3	BLUE	8	Ground	13	HSYNC
4	N/C	9	+5V	14	VSYNC
5	Ground	10	Ground	15	DDC_CLK

A.6<Parallel Port>

Connector: **LPT (PRINTER)**



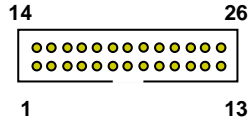



































Type: 26-pin (2 x 13) 2.54-pitch box header







































Pin	Description	Pin	Description
1	STROBE-	14	AUTO FEED-
2	D0	15	ERROR-
3	D1	16	INITIALIZE-
4	D2	17	SELECT INPUT-
5	D3	18	Ground
6	D4	19	Ground
7	D5	20	Ground
8	D6	21	Ground
9	D7	22	Ground
10	ACKNOWLEDGE-	23	Ground
11	BUSY	24	Ground
12	PAPER EMPTY	25	Ground
13	SELECT+	26	N/C

Appendix B <System Resources>

B.1 <I/O Port Address Map>























	[00000000 - 0000001F]	Direct memory access controller
	[00000000 - 00000CF7]	PCI bus
	[00000020 - 00000021]	Programmable interrupt controller
	[00000024 - 00000025]	Programmable interrupt controller
	[00000028 - 00000029]	Programmable interrupt controller
	[0000002C - 0000002D]	Programmable interrupt controller
	[0000002E - 0000002F]	Motherboard resources
	[00000030 - 00000031]	Programmable interrupt controller
	[00000034 - 00000035]	Programmable interrupt controller
	[00000038 - 00000039]	Programmable interrupt controller
	[0000003C - 0000003D]	Programmable interrupt controller
	[00000040 - 00000043]	System timer
	[0000004E - 0000004F]	Motherboard resources
	[00000050 - 00000053]	System timer
	[00000060 - 00000060]	Standard 101/102-Key or Microsoft Natural PS/2 Keyboard
	[00000061 - 00000061]	Motherboard resources
	[00000063 - 00000063]	Motherboard resources
	[00000064 - 00000064]	Standard 101/102-Key or Microsoft Natural PS/2 Keyboard
	[00000065 - 00000065]	Motherboard resources
	[00000067 - 00000067]	Motherboard resources
	[00000070 - 00000070]	Motherboard resources
	[00000070 - 00000077]	System CMOS/real time clock
	[00000080 - 00000080]	Motherboard resources
	[00000081 - 00000091]	Direct memory access controller
	[00000092 - 00000092]	Motherboard resources
	[00000093 - 0000009F]	Direct memory access controller
	[000000A0 - 000000A1]	Programmable interrupt controller
	[000000A4 - 000000A5]	Programmable interrupt controller
	[000000A8 - 000000A9]	Programmable interrupt controller
	[000000AC - 000000AD]	Programmable interrupt controller
	[000000B0 - 000000B1]	Programmable interrupt controller
	[000000B2 - 000000B3]	Motherboard resources
	[000000B4 - 000000B5]	Programmable interrupt controller
	[000000B8 - 000000B9]	Programmable interrupt controller
	[000000BC - 000000BD]	Programmable interrupt controller
	[000000C0 - 000000DF]	Direct memory access controller
	[000000F0 - 000000F0]	Numeric data processor
	[00000274 - 00000277]	ISAPNP Read Data Port

	[00000279 - 00000279]	ISAPNP Read Data Port
	[000002E8 - 000002EF]	Communications Port (COM4)
	[000002F8 - 000002FF]	Communications Port (COM2)
	[000003B0 - 000003BB]	Intel(R) HD Graphics Family
	[000003C0 - 000003DF]	Intel(R) HD Graphics Family
	[000003E8 - 000003EF]	Communications Port (COM3)
	[000003F8 - 000003FF]	Communications Port (COM1)
	[00000400 - 00000453]	Motherboard resources
	[00000454 - 00000457]	Motherboard resources
	[00000458 - 0000047F]	Motherboard resources
	[000004D0 - 000004D1]	Programmable interrupt controller
	[00000500 - 0000057F]	Motherboard resources
	[00000680 - 0000069F]	Motherboard resources
	[00000A79 - 00000A79]	ISAPNP Read Data Port
	[00000D00 - 0000FFFF]	PCI bus
	[00001000 - 0000100F]	Motherboard resources
	[0000164E - 0000164F]	Motherboard resources
	[00002000 - 0000201F]	Intel(R) 82574L Gigabit Network Connection #2
	[00002000 - 00002FFF]	Intel(R) 6 Series/C200 Series Chipset Family PCI Express Root Port 6 - 1C1A
	[00003000 - 0000301F]	Intel(R) 82574L Gigabit Network Connection
	[00003000 - 00003FFF]	Intel(R) 6 Series/C200 Series Chipset Family PCI Express Root Port 5 - 1C18
	[00004000 - 0000403F]	Intel(R) HD Graphics Family
	[00004060 - 0000406F]	Intel(R) 6 Series/C200 Series Chipset Family 2 port Serial ATA Storage Controller - 1C08
	[00004070 - 0000407F]	Intel(R) 6 Series/C200 Series Chipset Family 2 port Serial ATA Storage Controller - 1C08
	[00004080 - 0000408F]	Intel(R) 6 Series/C200 Series Chipset Family 4 port Serial ATA Storage Controller - 1C00
	[00004090 - 0000409F]	Intel(R) 6 Series/C200 Series Chipset Family 4 port Serial ATA Storage Controller - 1C00
	[000040A0 - 000040A7]	Intel(R) 6 Series/C200 Series Chipset Family 2 port Serial ATA Storage Controller - 1C08
	[000040A8 - 000040AF]	Intel(R) 6 Series/C200 Series Chipset Family 2 port Serial ATA Storage Controller - 1C08
	[000040B0 - 000040B7]	Intel(R) 6 Series/C200 Series Chipset Family 4 port Serial ATA Storage Controller - 1C00
	[000040B8 - 000040BF]	Intel(R) 6 Series/C200 Series Chipset Family 4 port Serial ATA Storage Controller - 1C00
	[000040C0 - 000040C3]	Intel(R) 6 Series/C200 Series Chipset Family 2 port Serial ATA Storage Controller - 1C08
	[000040C4 - 000040C7]	Intel(R) 6 Series/C200 Series Chipset Family 2 port Serial ATA Storage Controller - 1C08
	[000040C8 - 000040CB]	Intel(R) 6 Series/C200 Series Chipset Family 4 port Serial ATA Storage Controller - 1C00
	[000040CC - 000040CF]	Intel(R) 6 Series/C200 Series Chipset Family 4 port Serial ATA Storage Controller - 1C00
	[0000EFA0 - 0000EFBF]	Intel(R) 6 Series/C200 Series Chipset Family SMBus Controller - 1C22
	[0000FFFF - 0000FFFF]	Motherboard resources
	[0000FFFF - 0000FFFF]	Motherboard resources

B.2 <Memory Address Map>

	[000A0000 - 000BFFFF] Intel(R) HD Graphics Family
	[000A0000 - 000BFFFF] PCI bus
	[20000000 - 201FFFFFF] System board
	[40000000 - 401FFFFFF] System board
	[DFA00000 - FEFFFFFF] PCI bus
	[E0000000 - EFFFFFFF] Intel(R) HD Graphics Family
	[F0000000 - F03FFFFFF] Intel(R) HD Graphics Family
	[F0400000 - F041FFFF] Intel(R) 82574L Gigabit Network Connection #2
	[F0400000 - F04FFFFFF] Intel(R) 6 Series/C200 Series Chipset Family PCI Express Root Port 6 - 1C1A
	[F0420000 - F0423FFF] Intel(R) 82574L Gigabit Network Connection #2
	[F0500000 - F051FFFF] Intel(R) 82574L Gigabit Network Connection
	[F0500000 - F05FFFFFF] Intel(R) 6 Series/C200 Series Chipset Family PCI Express Root Port 5 - 1C18
	[F0520000 - F0523FFF] Intel(R) 82574L Gigabit Network Connection
	[F0600000 - F0603FFF] Microsoft UAA Bus Driver for High Definition Audio
	[F0604000 - F06040FF] Intel(R) 6 Series/C200 Series Chipset Family SMBus Controller - 1C22
	[F0606000 - F06063FF] Intel(R) 6 Series/C200 Series Chipset Family USB Enhanced Host Controller - 1C26
	[F0607000 - F06073FF] Intel(R) 6 Series/C200 Series Chipset Family USB Enhanced Host Controller - 1C2D
	[F8000000 - FBFFFFFF] Motherboard resources
	[FED00000 - FED003FF] High precision event timer
	[FED10000 - FED17FFF] Motherboard resources
	[FED18000 - FED18FFF] Motherboard resources
	[FED19000 - FED19FFF] Motherboard resources
	[FED1C000 - FED1FFFF] Motherboard resources
	[FED20000 - FED3FFFF] Motherboard resources
	[FED40000 - FED44FFF] PCI bus
	[FED45000 - FED8FFFF] Motherboard resources
	[FED90000 - FED93FFF] Motherboard resources
	[FEE00000 - FEEFFFFFF] Motherboard resources
	[FF000000 - FFFFFFFF] Intel(R) 82802 Firmware Hub Device
	[FF000000 - FFFFFFFF] Motherboard resources

B.3 <System IRQ Resources>

-  (ISA) 0 System timer
-  (ISA) 1 Standard 101/102-Key or Microsoft Natural PS/2 Keyboard
-  (ISA) 3 Communications Port (COM2)
-  (ISA) 4 Communications Port (COM1)
-  (ISA) 8 System CMOS/real time clock
-  (ISA) 9 Microsoft ACPI-Compliant System
-  (ISA) 11 Communications Port (COM3)
-  (ISA) 11 Communications Port (COM4)
-  (ISA) 12 PS/2 Compatible Mouse
-  (ISA) 13 Numeric data processor
-  (PCI) 7 Intel(R) 6 Series/C200 Series Chipset Family SMBus Controller - 1C22
-  (PCI) 16 Intel(R) 6 Series/C200 Series Chipset Family PCI Express Root Port 1 - 1C10
-  (PCI) 16 Intel(R) 6 Series/C200 Series Chipset Family PCI Express Root Port 5 - 1C18
-  (PCI) 16 Intel(R) 6 Series/C200 Series Chipset Family USB Enhanced Host Controller - 1C2D
-  (PCI) 16 Intel(R) 82574L Gigabit Network Connection
-  (PCI) 16 Intel(R) HD Graphics Family
-  (PCI) 17 Intel(R) 6 Series/C200 Series Chipset Family PCI Express Root Port 6 - 1C1A
-  (PCI) 17 Intel(R) 82574L Gigabit Network Connection #2
-  (PCI) 19 Intel(R) 6 Series/C200 Series Chipset Family 2 port Serial ATA Storage Controller - 1C08
-  (PCI) 19 Intel(R) 6 Series/C200 Series Chipset Family 4 port Serial ATA Storage Controller - 1C00
-  (PCI) 19 Intel(R) 6 Series/C200 Series Chipset Family PCI Express Root Port 8 - 1C1E
-  (PCI) 22 Microsoft UAA Bus Driver for High Definition Audio
-  (PCI) 23 Intel(R) 6 Series/C200 Series Chipset Family USB Enhanced Host Controller - 1C26

Appendix C <Programming GPIO's>

The GPIO can be programmed with the MSDOS debug program using simple IN/OUT commands. The following lines show an example how to do this.

GPIO0.....GPIO7 bit0.....bit7

```
-o 2E 87          ;enter configuration
-o 2E 87
-o 2E 07
-o 2F 09          ;enale GPIO function
-o 2E 30
-o 2F 02          ;enable GPIO configuration
-o 2E F0
-o 2F xx          ;set GPIO as input/output; set '1' for input,'0'for output
-o 2E F1
-o 2F xx          ;if set GPIO's as output,in this register its value can be set
```

Optional :

```
-o 2E F2
-o 2F xx          ; Data inversion register ; '1' inverts the current valus of the bits ,'0'
                  leaves them as they are
-o 2E 30
-o 2F 01          ; active GPIO's
```

For further information ,please refer to Winbond W83627DHG-P datasheet.

Appendix D <Watch Dog timer Setting >

The watchdog timer makes the system auto-reset while it stops to work for a period. The integrated watchdog timer can be setup as system reset mode by program.

Timeout Value Range

- 1 to 255
- Second or Minute

Program Sample

Watchdog timer setup as system reset with 5 second of timeout

2E, 87	
2E, 87	
2E, 07	
2F, 08	Logical Device 8
2E, 30	Activate
2F, 01	
2E, F5	Set as Second*
2F, 00	
2E, F6	Set as 5
2F, 05	

* Minute: bit 3 = 0; Second: bit 3 = 1

You can select Timer setting in the BIOS, after setting the time options, the system will reset according to the period of your selection.

Contact Information

Any advice or comment about our products and service, or anything we can help you please don't hesitate to contact with us. We will do our best to support you for your products, projects and business.

Taiwan Commate Computer Inc.

Address	19F., No.94, Sec. 1, Xintai 5th Rd., Xizhi Dist., New Taipei City 22102, Taiwan
TEL	+886-2-26963909
FAX	+886-2-26963911
Website	http://www.commell.com.tw
E-Mail	info@commell.com.tw (General Information) tech@commell.com.tw (Technical Support)
Facebook	https://www.facebook.com/pages/Taiwan-Commate-Computer-Inc/547993955271899
Twitter	https://twitter.com/Taiwan_Commamate

Commell is a brand name of Taiwan commate computer Inc.