

CMB-672/674

Mini Barebone system
Intel High Performance Platform
Installation Guide

Edition 1.0

2006/07/30



Document Content:

- Packing List
- Product Specification
- Hardware Installation

Packing List:

CMB-672/674 Chassis x 1



(Including LV-672/LV-674 Motherboard)

DCP-PSG300 300W AC-DC Adapter x1

Slim FDD Cable x 1

40-pin to 40-pin UDMA IDE Cable x1

SATA Cable x2

PCIE-3P1 x1

IDE to Slim CD-ROM Module x1

CD Driver x1

Raid Driver disc x1

CMB-672/674

Hardware Installation:

Motherboard placement

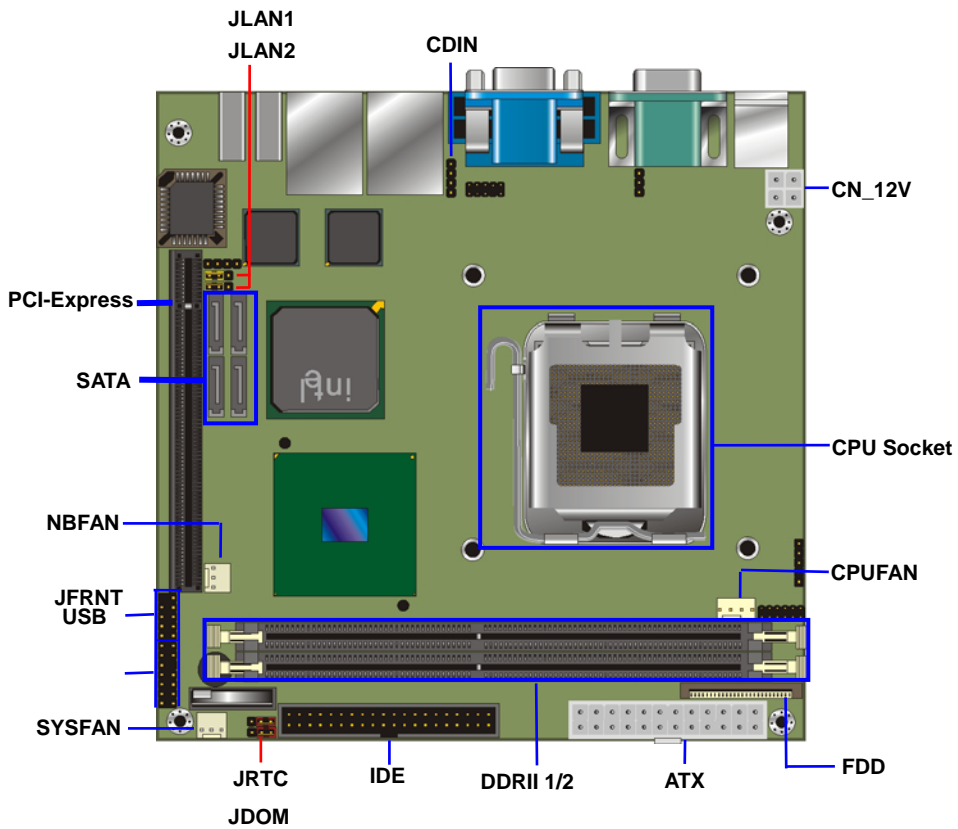

Components showed is available for CMB-672 only

— For Connector

— For Jumper

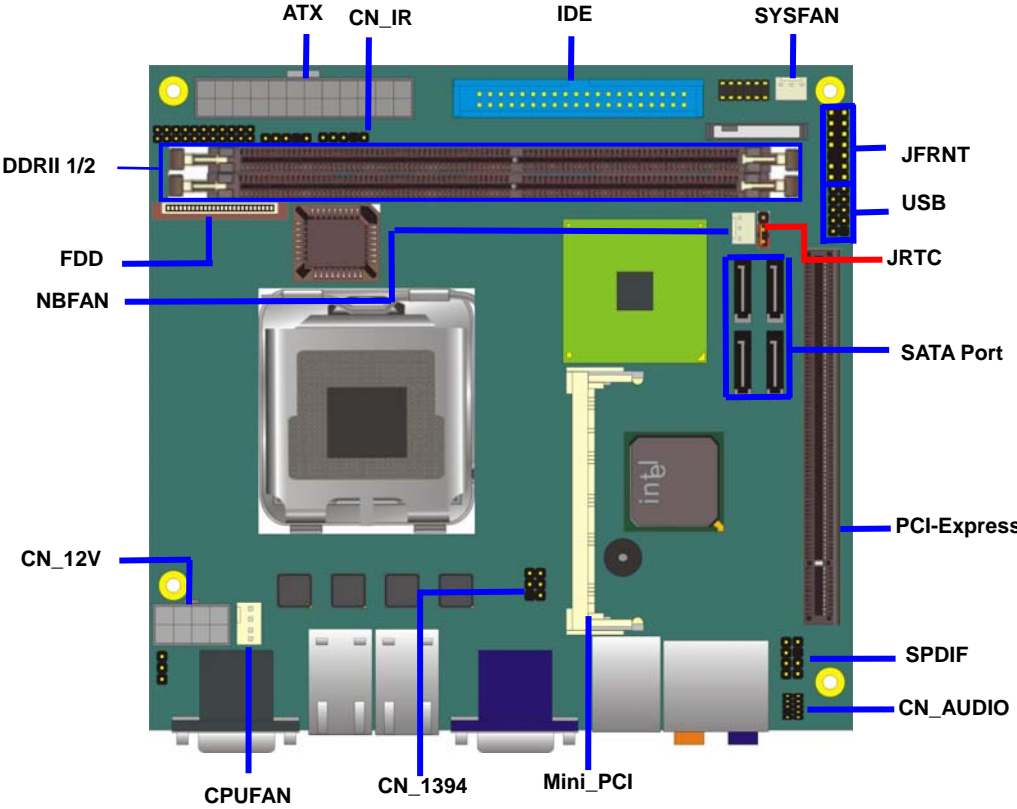

Components showed is available for CMB-674 only

— For Connector — For Jumper

I/O panel:

LV-672/LV-674 Front:

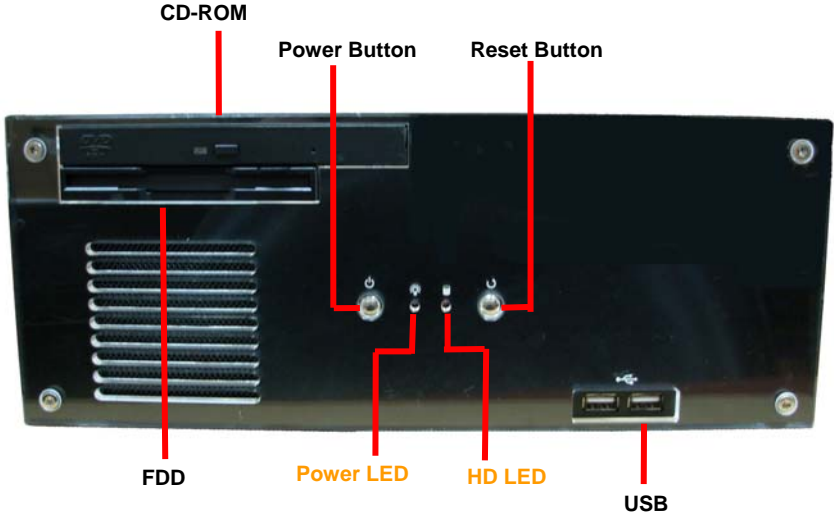

LV-672 Rear:

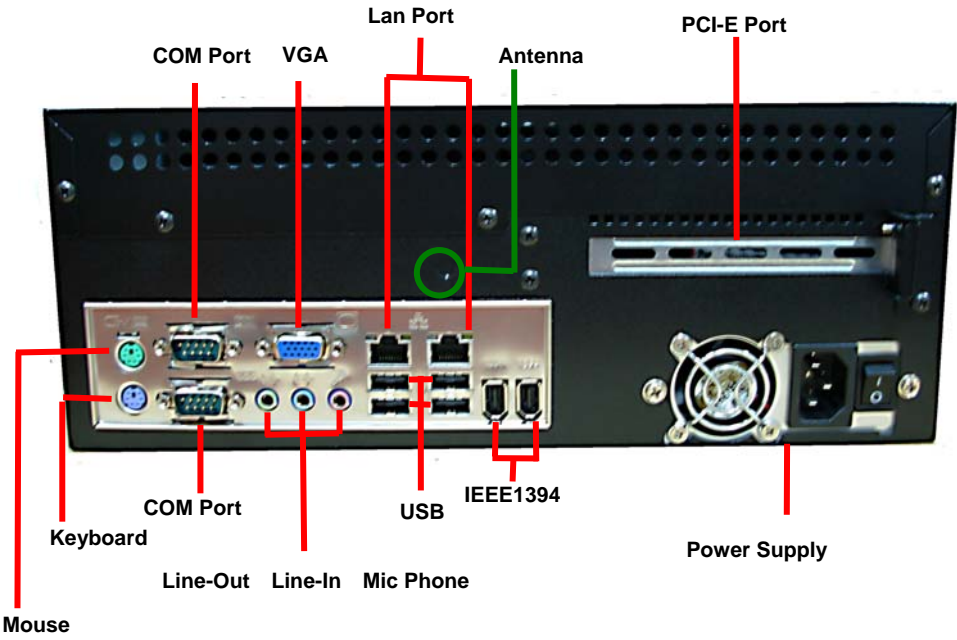

LV-674 Rear:

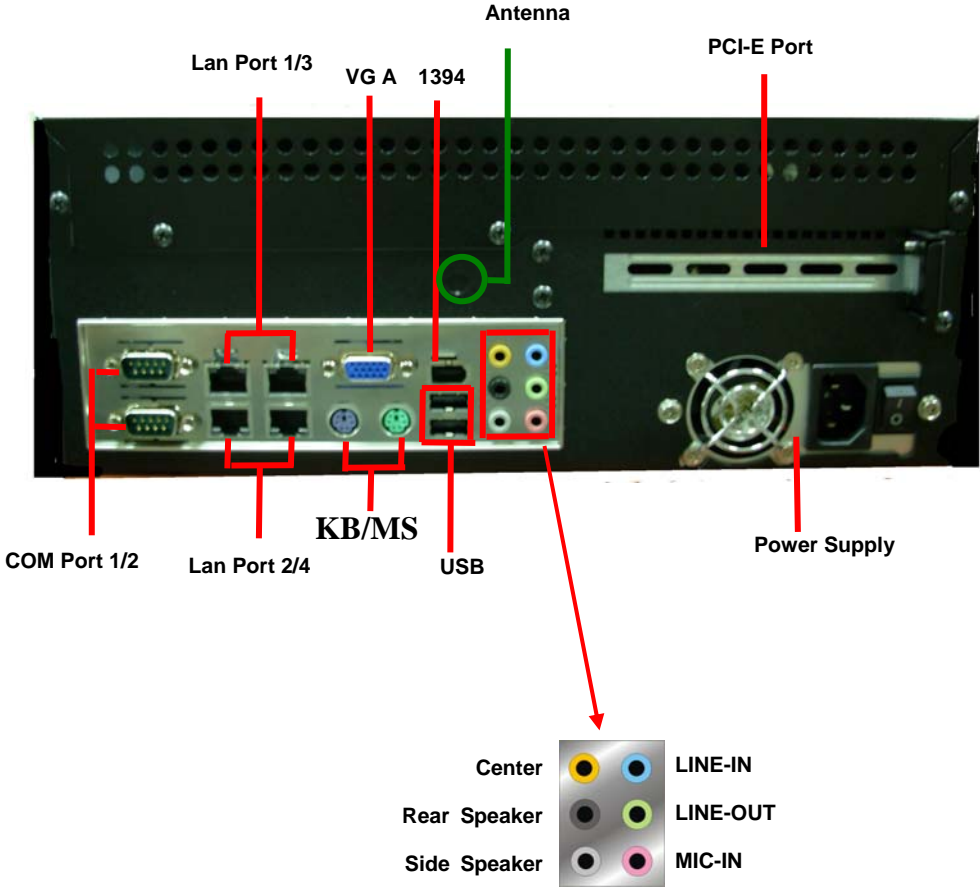

▪ Chassis Setup procedure:

1. Turn the chassis screws.

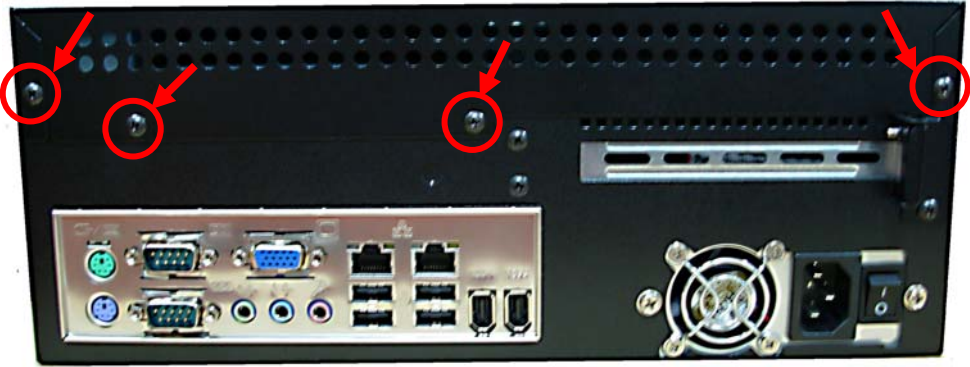

2. Push the Chassis shield towards the back then open it .



3. Turn the holder screws and open it.



4. Be carefully to take the CPU Fan off.



5. Open the CPU cover and refer the motherboard manual page.16 to install the CPU.

(After installed CPU, please remember to install the CPU Fan back)

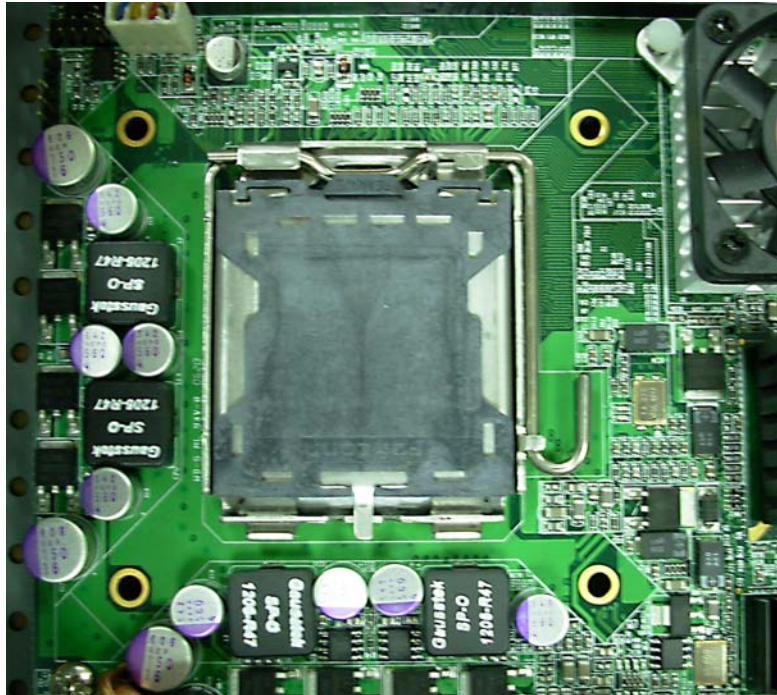

6. Open the Dimm holder then check the pin number to match the socket side well before installing memory module.

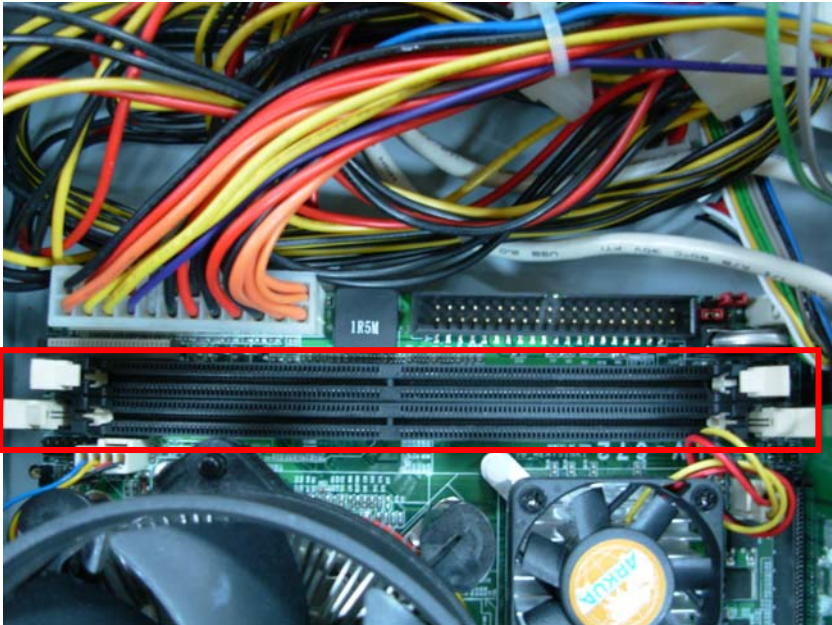

7. Press down the memory module then check dimm holder hook well.

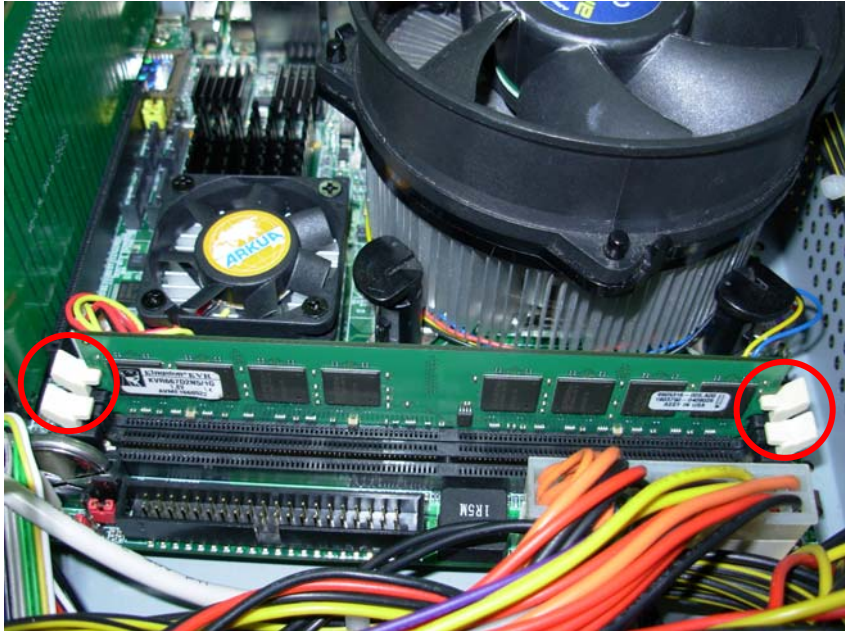

8. Turn the PCI-E port shield's screw and take shield off refer picture A and B. (If you don't install PCI-E card, please direct to Step 11 .)

(A).

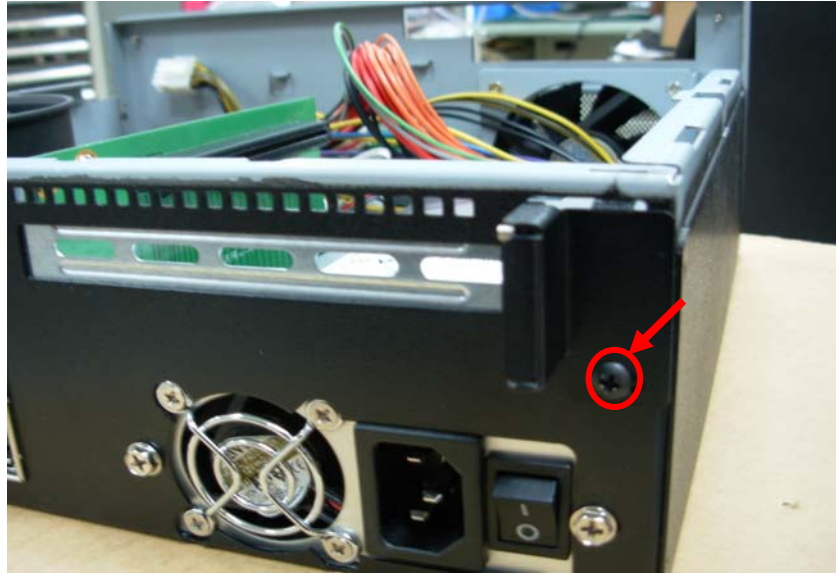

(B)

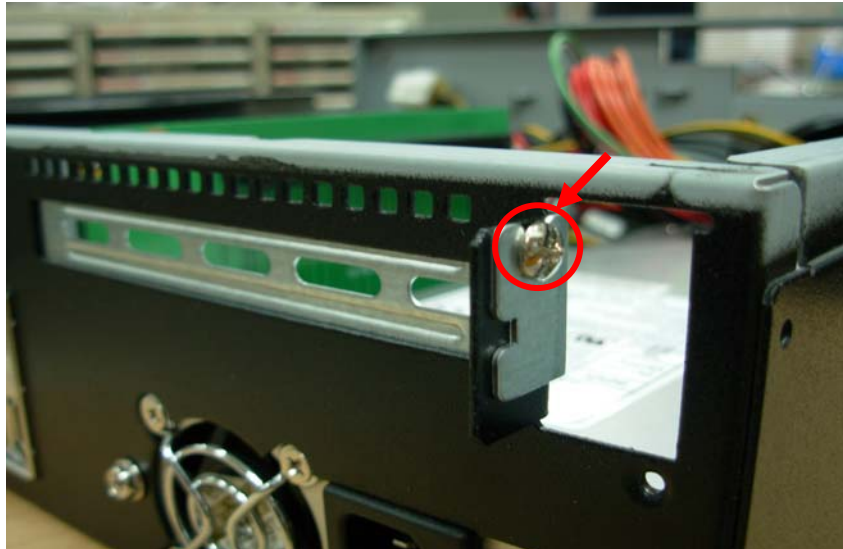

(C)



9. Put into the PCI-E Card. And Check the connects into the riser card well then turns shield screw.



10. Take the holder to install HD driver. This holder can install two 3.5" HD driver or four 2.5" HD driver. To refer the picture (a) and (b).

(a)

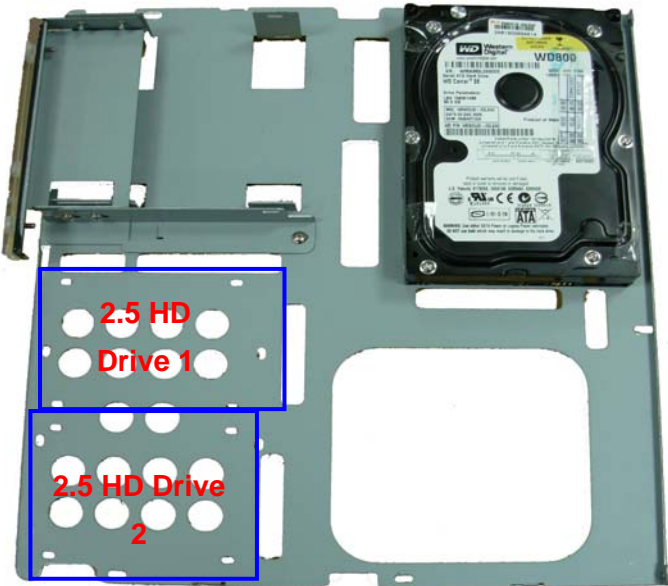

(b)

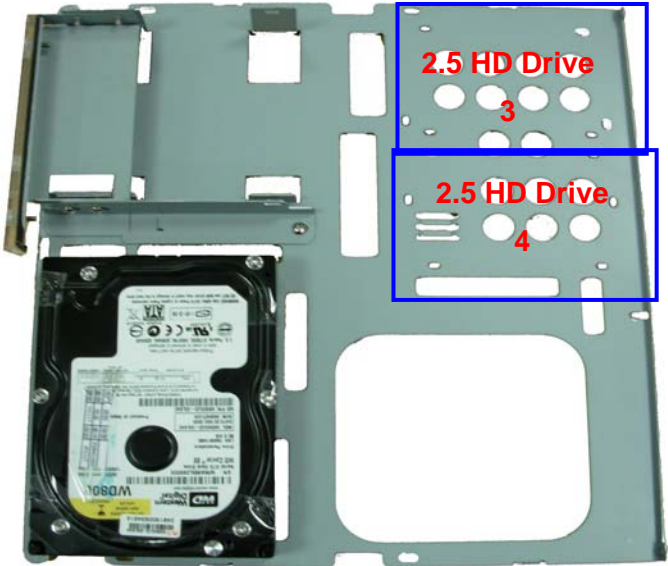

11. Put into HD driver and connect the cable well then turn the HD driver screws. (If you don't have HD driver, please direct to step 12.)

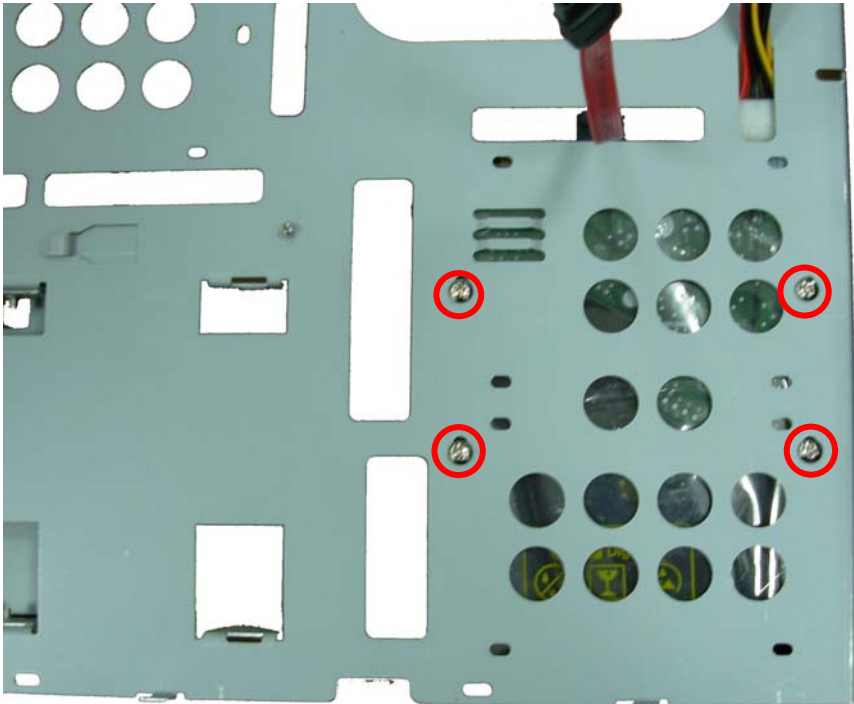

12. Before Install Floppy. Turn the CD-ROM and Floppy shield screw.
(If you don't have floppy, please direct to step 15.)

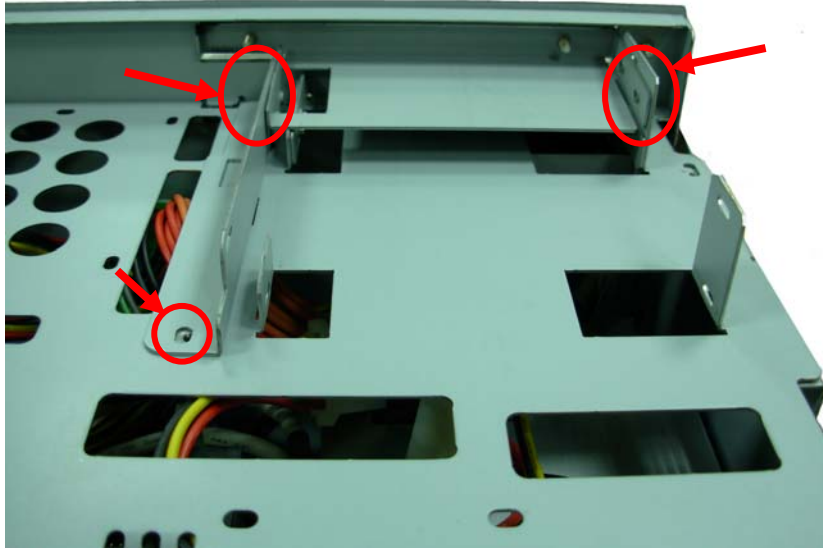

13. Take the CD-ROM and Floppy shield off.

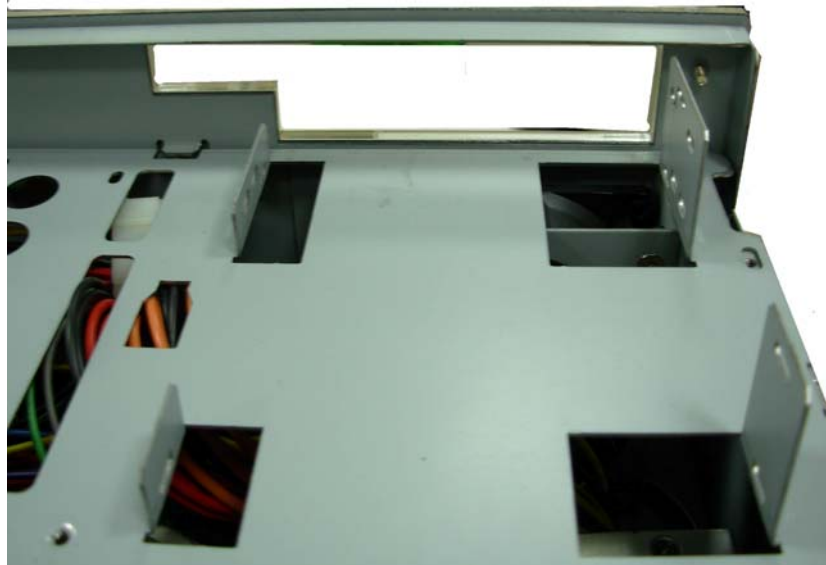

14. Turn the floppy Screws then refer motherboard manual page “21” to connect the floppy cable correctly.



15. Before Install the CD-ROM. Turn the CD-ROM shield screws and take it off. (If you don't have the CD-ROM, please direct to step 18.)

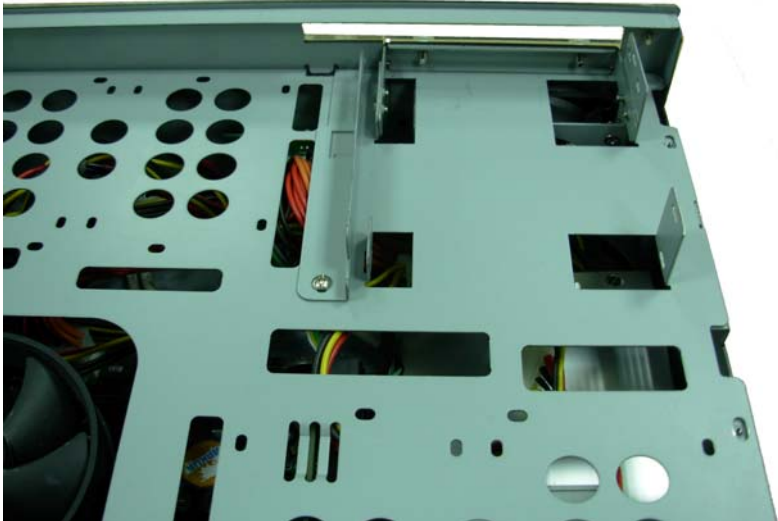

16. Insert CD-ROM into the chassis from front panel.



17. To tighten the CD-ROM and holder screws.

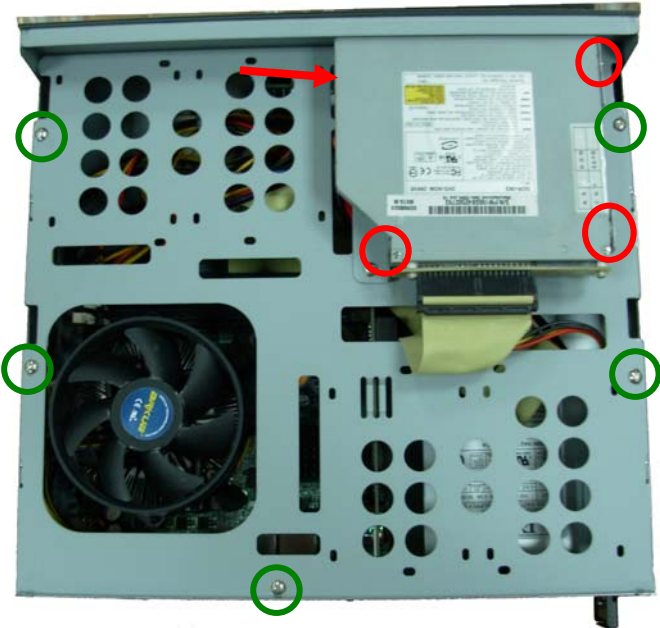

18. To tighten the chassis shield screws well.



- **Mini-PCI card Setup procedure(For CMB-672):**

1. Turn the mini-PCI chassis shield screws.

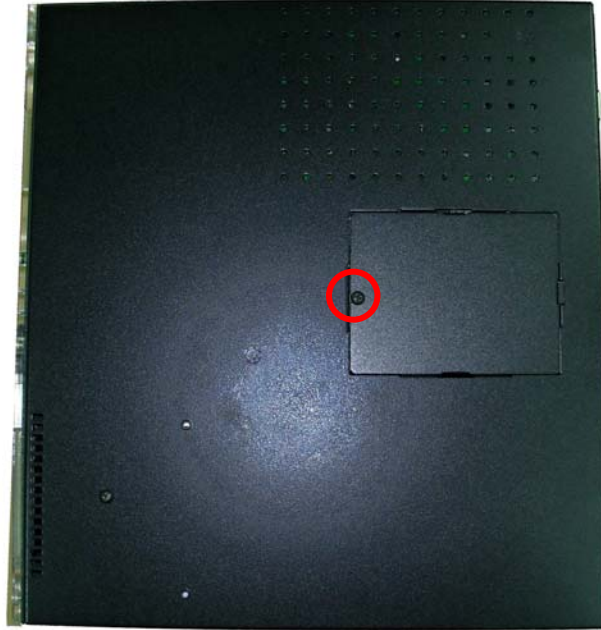

2. Take mini-PCI chassis shield off.



- 3. Follow the Idiot-proof design then insert the mini-PCI card then press down.

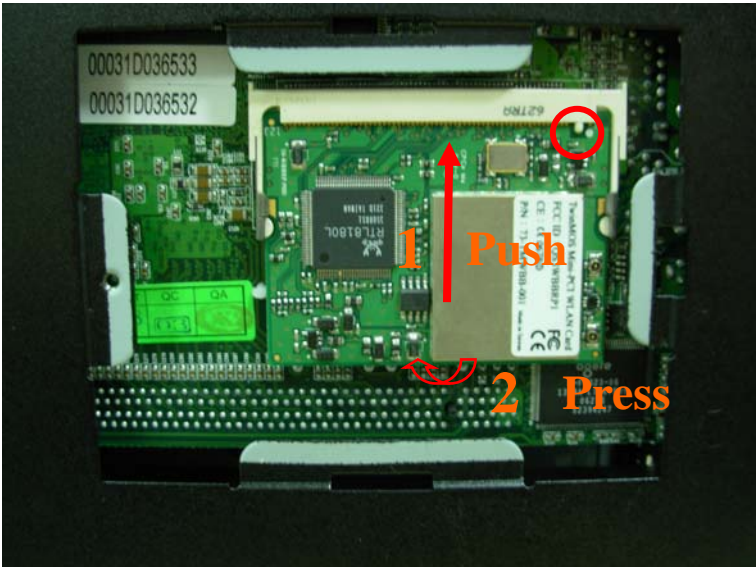

- 4. To close mini-PCI chassis shield and tighten a screw.

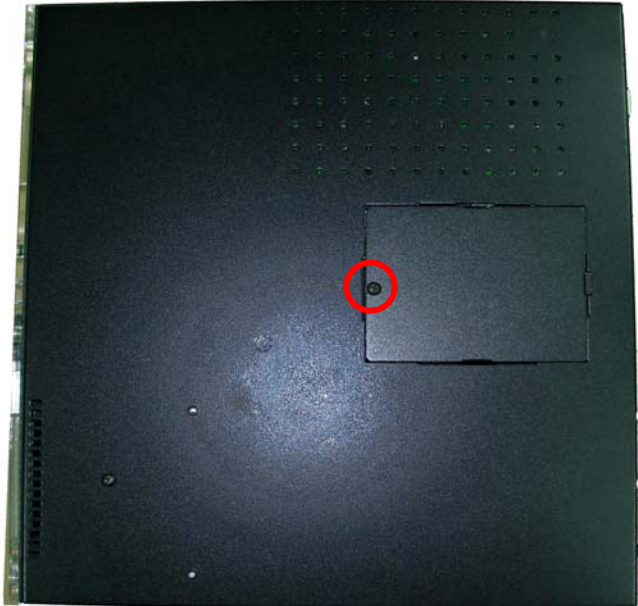

Contact Information

Any advice or comment about our products and service, or anything we can help you please don't hesitate to contact with us. We will do our best to support you for your products, projects and business

Taiwan Commate Computer Inc.

Address	19F, No. 94, Sec. 1, Xintai 5th Rd., Xizhi Dist New Taipei City, Taiwan
TEL	+886-2-26963909
FAX	+886-2-26963911
Website	http://www.commell.com.tw
E-Mail	info@commell.com.tw (General Information) tech@commell.com.tw (Technical Support)
Facebook	https://www.facebook.com/pages/Taiwan-Commate-Computer-Inc/547993955271899
Twitter	https://twitter.com/Taiwan_Commamate

Commell is a brand name of Taiwan Commate Computer Inc.

