

FS-97A

Full-size Single Board Computer

User's manual

Edition 1.3

2009/9/15

Copyright

Copyright© 2003 - 2004. All rights reserved. This document is copyrighted and all rights are reserved. The information in this document is subject to change without prior notice to make improvements to the products.

This document contains proprietary information and protected by copyright. No part of this document may be reproduced, copied, or translated in any form or any means without prior written permission of the manufacturer.

All trademarks and/or registered trademarks contains in this document are property of their respective owners.

Disclaimer

The company shall not be liable for any incidental or consequential damages resulting from the performance or use of this product.

The company does not issue a warranty of any kind, express or implied, including without limitation implied warranties of merchantability or fitness for a particular purpose. The company has the right to revise the manual or include changes in the specifications of the product described within it at any time without notice and without obligation to notify any person of such revision or changes.

Trademark

All trademarks are the property of their respective holders.

Any questions please visit our website at <http://www.commell.com.tw>.

Packing List:

Please check the package material before you install the system.

Hardware:

FS-97A Single Board Computer x 1

Cable Kit:



40-pin ATA100 IDE flat cable x 2



Floppy flat cable x 1

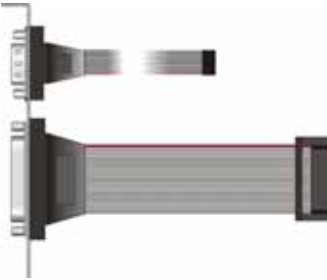

DB25 & DB9 cable with bracket x 1
(FS-97AVL only)

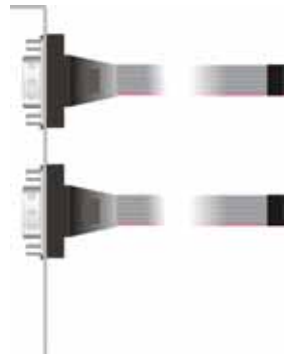

Dual DB9 cable with bracket x 1
(FS-97AVL2 only)

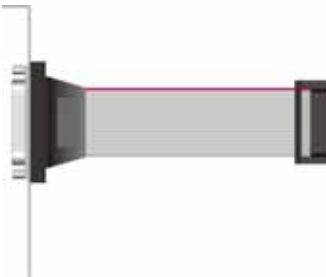

DB25 cable with bracket x 1
(FS-97AVL2 only)

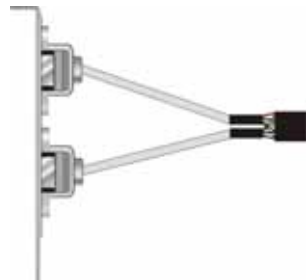

Dual USB cable with bracket x 2

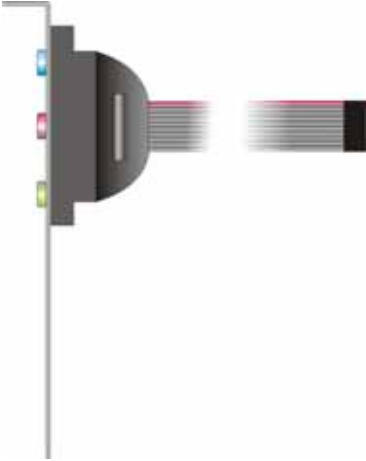

Audio cable with bracket x 1

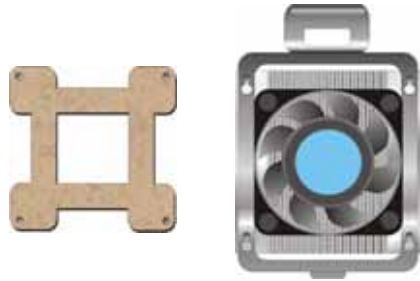

CPU Cooler x 1



4-pin to 3-pin ATX cable x 1



PS/2 Keyboard & Mouse Cable x 1

Other Accessories:

Divers CD (including User's Manual)

Index

Chapter 1 <Introductions>	7
1.1 < Product Overview>.....	7
1.2 <Product Specifications>.....	8
1.3 <Component Placement>	10
1.4 <Block Diagram>.....	11
Chapter 2 <Hardware Setup>	13
2.1 <Connectors Location>	13
2.2 <Jumper Reference>	14
2.3 <Connectors Reference>	15
2.3.1 <Internal Connectors>	15
2.3.2 <External Connectors>.....	15
2.4 <System Setup>.....	16
2.4.1 <CPU Installation>.....	16
2.4.2 <Memory Module Installation>	17
2.4.3 <CPU Cooler Installation>	18
2.4.4 <Complete the system installation>	19
2.5 <CMOS Setup>	20
2.6 <Watchdog Timer Setting>.....	21
2.7 <Embedded Solid State Disk>	22
2.8 <Power and Fan Setup>	23
2.9 <Display Interface>	24
2.9.1 <Analog VGA interface>.....	24
2.9.2 <Digital VGA interface>	25
2.10 < Ethernet Network Interface>	29
2.11 <Audio Interface>	30
2.12 <GPIO interface>	31
2.13 <Switch and Indicator>.....	32

Chapter 3 <Display Mode Setup>	33
Chapter 4 <BIOS Setup>	37
Appendix A <I/O ports pin assignment>	39
A.1 <IDE Port>	39
A.2 <Floppy Port>	40
A.3 < Parallel Port>	41
A.4 <Serial Port>	42
A.4.1 <External DB9 COM>	42
A.4.2 <Internal COM2>.....	42
A.5 <USB Port>.....	43
A.6 <IrDA Port>	43
A.7 <VGA Port>.....	44
A.8 <LAN Port>	45
A.8.1 <Gigabit Ethernet Controller>	45
A.8.2 <Ethernet Controller>.....	45
A.9 <AT Keyboard Port>	46
A.10 <PS/2 Keyboard & Mouse Port>.....	46
Appendix B <Flash BIOS>	47
B.1 BIOS Auto Flash Tool	47
B.2 Flash Method.....	47
Appendix C <Watchdog Timer Programming Guide>	49

Chapter 1 <Introductions>

1.1 < Product Overview>

The **FS-97A** is an all-in-one single board computer with PICMG interface. Based on Intel Mobile solutions with 855GME chipset, it supports Intel Pentium M processor with socket479, DDR266/333 SDRAM up to 2GB of capacity, Intel Extreme Graphics 2 Technology of onboard VGA display interface, AC97 2 channel audio, USB2.0 interface and one Gigabit Ethernet controller.

To be a powerful multimedia platform, **FS-97A** is also integrated with 24-bit dual channel LVDS interface and one Compact Flash Type II socket. For these features **FS-97A** can be easily used for industrial multimedia platform like POS or KIOSK system.

Powerful Embedded System

FS-97A also supports Intel Pentium M FC-BGA2 for embedded, you can choose it for lower voltage and power consumption, further more, and it can be done for fan free system.

With one compact flash type II socket, you can port embedded operating system like windows CE.net or Linux Embedded for it.

Hi-Speed USB 2.0 Interface

Intel ICH4 built-in Hi-Speed USB 2.0 controller let **FS-97A** offering up to 480Mbps of Hi-Speed USB 2.0 interfaces.

1.2 <Product Specifications>

General Specification

Form Factor	Full-size PICMG CPU card
CPU	Intel Pentium M Processor with FC-PGA478/FC-BGA479 FSB: 400MHz L2 Cache: 512KB/1MB/2MB Battery Mode is not supported Intel Speed Step Technology function is not supported (The Intel® Celeron® M Processor 4xx series have been designed to work with the Mobile Intel® 945 Express Chipset Family only .)
Memory	2GBytes DDR200/266/333 SDRAM on one 184-pin DIMM socket ECC is supported
Chipset	Intel 82855GME GMCH and 82801DB ICH4
BIOS	Phoenix-Award v6.00PG 4Mb PnP flash BIOS
Green Function	Power saving mode includes doze, standby and suspend modes. ACPI version 1.0 and APM version 1.2 compliant
Watchdog Timer	System reset programmable watchdog timer with 1 ~ 255 sec./min. of timeout value
Real Time Clock	Intel ICH4 built-in RTC with lithium battery
Enhanced IDE	PCI enhanced IDE interface supports dual channels and up to 4 ATAPI devices at UltraATA/100 Two 40-pin IDE ports DiskOnModule (DOM) embedded flash disk up to 1GBytes

Multi-I/O Port

Chipset	Intel 82801DB ICH4 and Winbond W83627HF-AW LPC Super I/O controller
Serial Port	Two internal RS-232 serial port with 16C550 compatible UART and 16 bytes FIFO
USB Port	Four Hi-Speed USB 2.0 ports with 480 Mbps of transfer rate
Parallel Port	One internal bi-direction parallel port with SPP/ECP/EPP mode
Floppy Port	One FDD port supports up to two FDD
IrDA Port	One IrDA compliant Infrared interface supports SIR
K/B & Mouse	External PS/2 keyboard and mouse ports on rear I/O panel One internal AT keyboard port
GPIO	One 12-pin Digital I/O connector with 8-bit programmable I/O interface

VGA Display Interface

Chipset	Intel 855GME GMCH built-in Intel Extreme Graphics 2 With 266 MHz VGA core and 256-bit 3D engine
Memory	Intel dynamic video memory up to 64Mbytes shared with system
Display Type	CRT, LCD monitor and analog display

Connector	External DB15 female connector on rear I/O panel Internal 40-pin LVDS connector
-----------	--

Ethernet Interface

Chipset	Intel PRO/100+ LAN interface with Intel 82562ET Optional secondary Gigabit LAN interface with Intel 82540EM
Type	10Base-T / 100Base-TX/1000Base-T for 82540EM 10Base-T / 100Base-TX for 82562ET auto-switching Fast Ethernet Full duplex, IEEE802.3U compliant
Connector	External RJ45 connector with LED on rear I/O panel

Audio Interface

Chipset	Intel ICH4 with Realtek ALC201A AC97 3D audio codec
Interface	2 channel 3D audio with Line-in, Line-out and MIC-in
Connector	Internal 10-pin header for line-in/-out, MIC-out, 4-pin header for CD-in

Extended Interface

Type	Onboard 144-pin Mini-AGP interface
Bus type	4x AGP bus

Solid State Disk Interface

Flash Type	Compact Flash Type-I/II for CFC (Compact Flash Card) or IBM MicroDrive
Capacity	Up to 1GB flash memory

Power and Environment

Power Requirement	4-pin onboard +5V/+12V power connector
ATX function	Onboard 3-pin PS-ON & 5V standby connector
Dimension	338 (L) x 122 (H) mm
Temperature	Operating within 0 ~ 60°C (32 ~ 140°F) Storage within -20 ~ 85°C (-4 ~ 185°F)

Ordering Code

FS-97AVL	Full-size PICMG single board computer with Intel Socket 479 Pentium-M processor Motherboard with Intel onboard VGA, LAN, Audio, Hi-Speed USB 2.0, Compact Flash socket and LVDS interface.
FS-97AVL2	Same as above and with secondary Gigabit LAN

For further product information please visit the website at <http://www.comnell.com.tw>

1.3 <Component Placement>

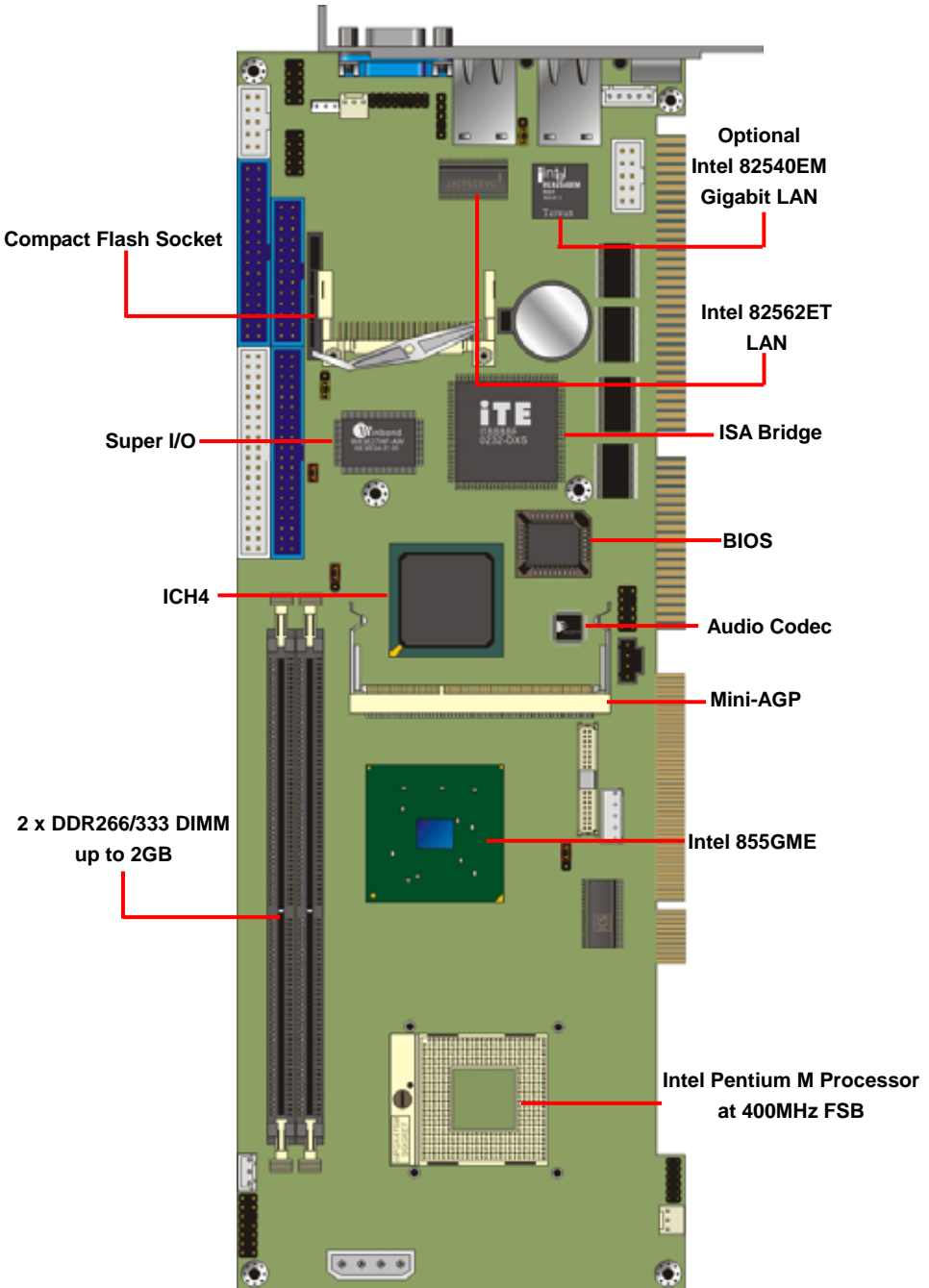

1.4 <Block Diagram>

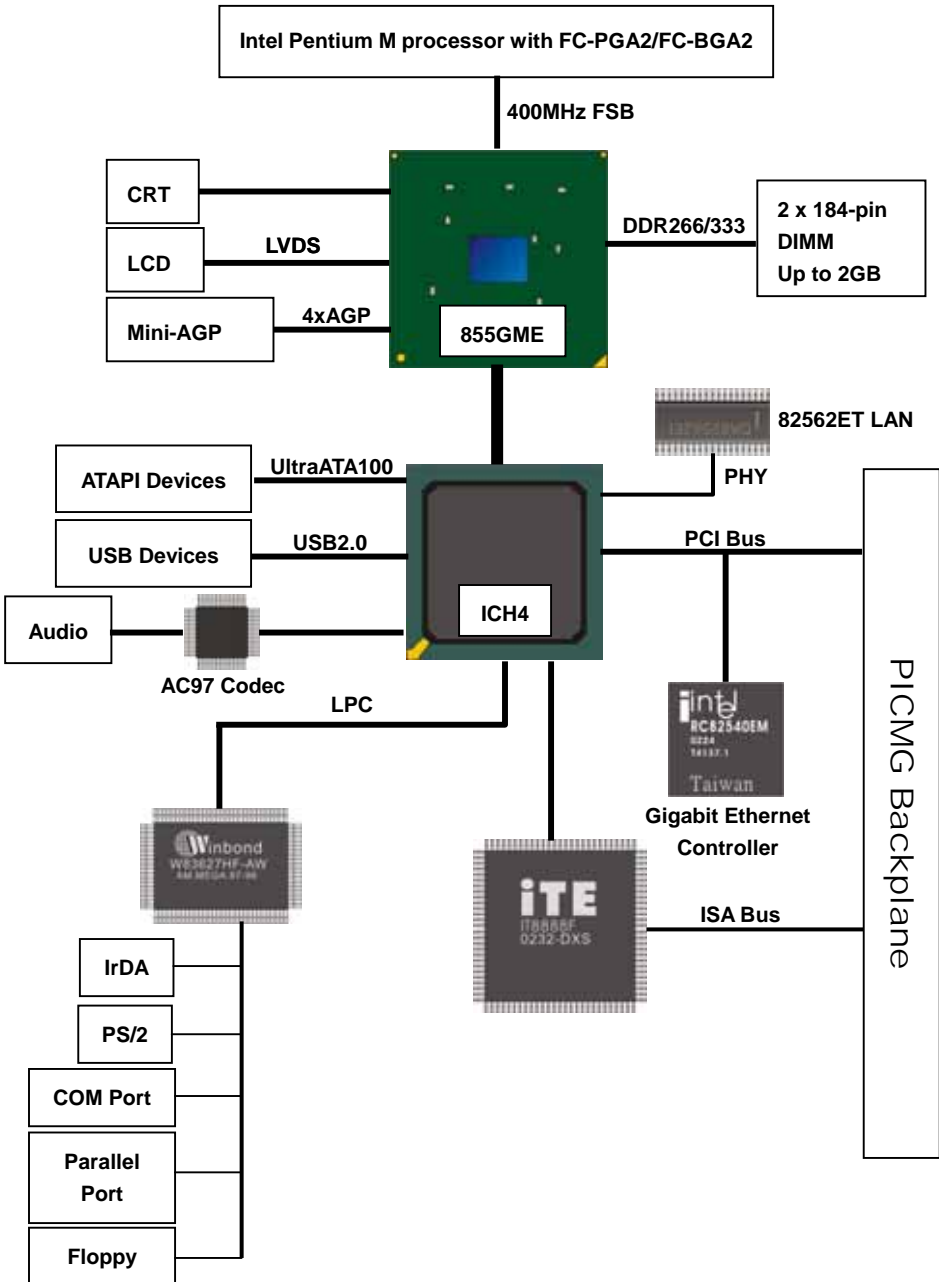

(This Page is Left for Blank)

(This Page is Left for Blank)

Chapter 2 <Hardware Setup>

2.1 <Connectors Location>

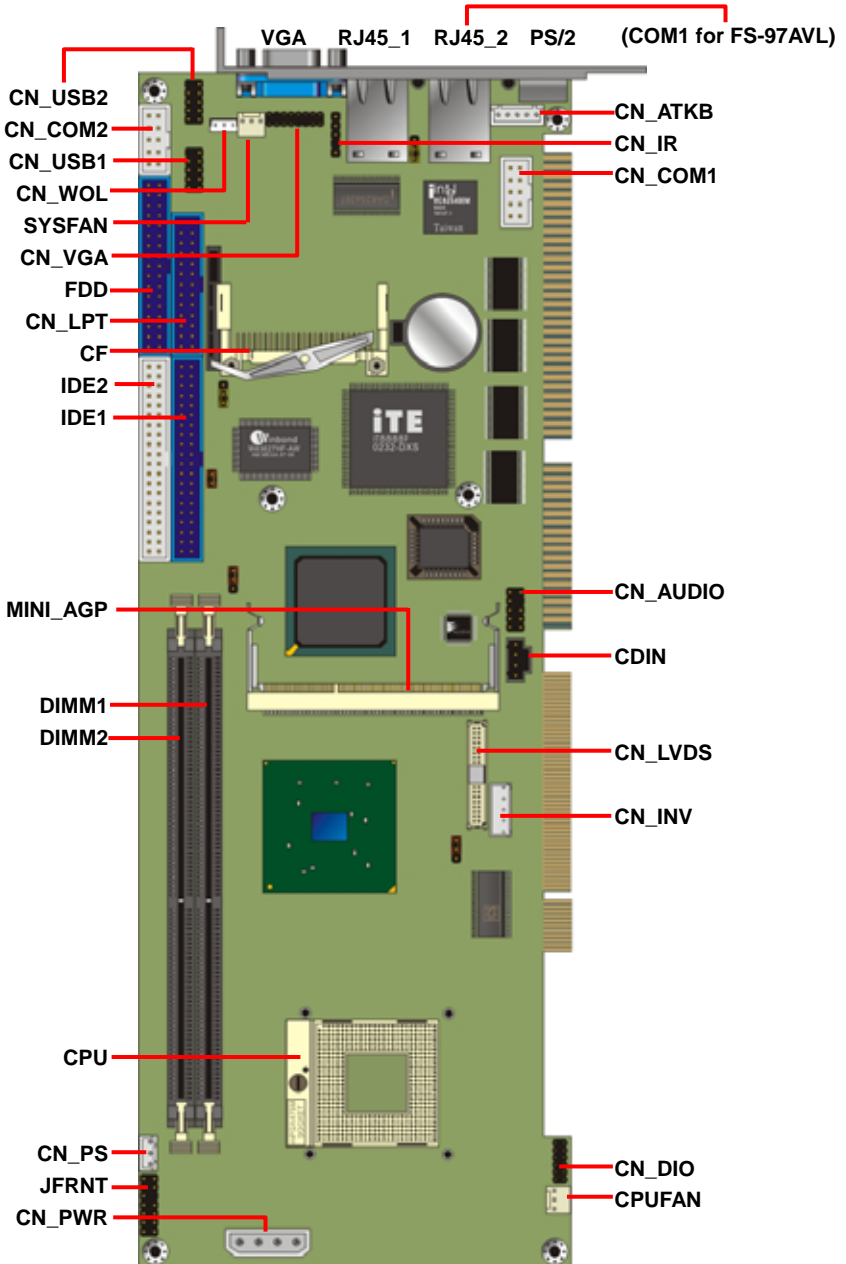

2.2 <Jumper Reference>

Jumper	Function
JRTC	CMOS Operating/Clear Setting
JCFSEL	Compact Flash Addressing Setting
JDOM	IDE1 Pin-20 voltage setting
JVLCD	LCD Panel Voltage Setting
JLAN	Ethernet Controller Enable/Disable Setting

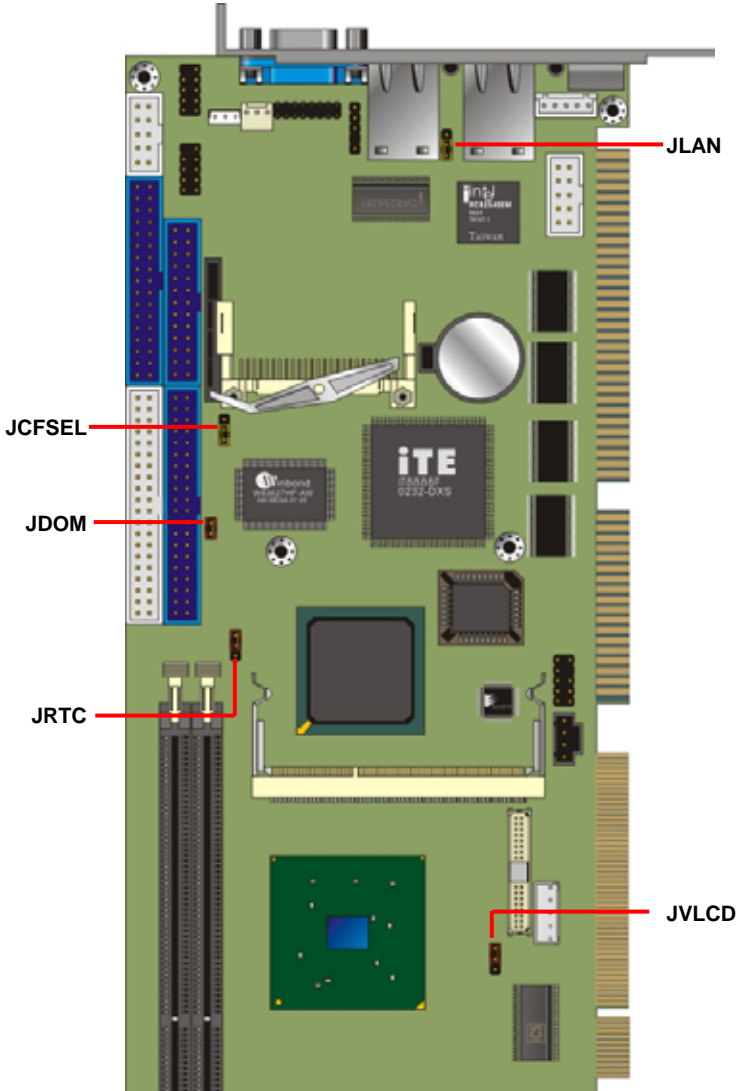

2.3 <Connectors Reference>

2.3.1 <Internal Connectors>

Connector	Function	Remark
CPU	mPGA479 CPU socket	Standard
DIMM1/2	184 -pin DDR SDRAM DIMM socket	Standard
IDE1	40-pin primary IDE connector	Standard
IDE2	44-pin secondary IDE connector	Standard
FDD	34-pin floppy connector	Standard
CN_VGA	8 x 2-pin VGA connector (pitch = 2.0mm)	Standard
CN_USB1/2	5 x 2-pin USB connector (pitch =2.54mm)	Standard
CN_COM1/2	5 x 2-pin serial port connector	Standard
CN_LVDS	20 x 2-pin LVDS connector	Standard
CN_INV	5-pin panel inverter connector	Standard
CN_PS	3-pin ATX function connector	Standard
CN_PWR	4-pin power input connector	Standard
CN_AUDIO	5 x 2-pin audio connector	Standard
CDIN	4-pin CD-ROM audio input connector	Standard
CN_DIO	6 x 2-pin digital I/O connector	Standard
CN_WOL	3-pin wake-on-LAN connector	Standard
CPUFAN	3-pin CPU fan connector	Standard
SYSFAN	3-pin system fan connector	Standard
CN_LPT	26-pin parallel port connector	Standard
CF	Compact Flash Type II socket	Standard

2.3.2 <External Connectors>

Connector	Function	Remark
VGA	DB15 VGA connector	Standard
RJ45_1	RJ45 LAN connector	Standard
RJ45_2	RJ45 LAN connector	FS-97AVL2
COM1	Serial port connector	FS-97AVL
PS2	PS/2 Keyboard/Mouse connector	Standard

2.4 <System Setup>

2.4.1 <CPU Installation>

FS-97A has one 479-pin CPU socket to support Intel Pentium M/Celeron M 478-pin processor. Please follow the instruction to install the processor well.



1. Use flat-type Screw Driver to unlock the CPU locket

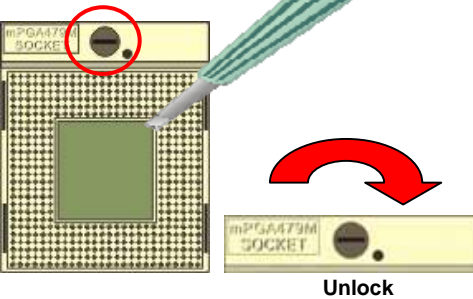

2. Find the pin direction and install the processor on the socket.

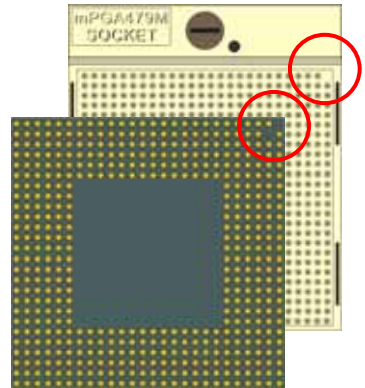

3. Lock the socket well.

2.4.2 <Memory Module Installation>

FS-97A supports two DDR266/333 SDRAM sockets up to 2GB of capacity. It also supports ECC (error- correcting code) function.

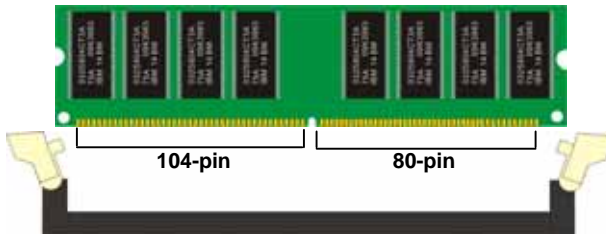
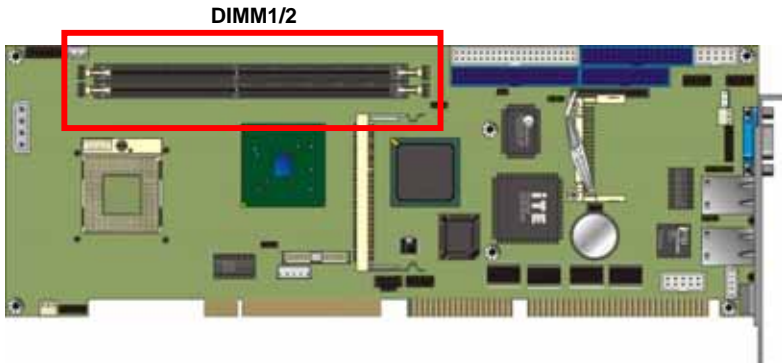

Please check the pin number to match the socket side well before installing memory module.

2.4.3 <CPU Cooler Installation>

There is a cooler attached with the board package, please follow the instructions to install the cooler on the processor.

1. Remove the sticker of the base.



2. Put the base through the fixing hole of the processor and paste on the solder side. Then put the cooler through the base pillar.

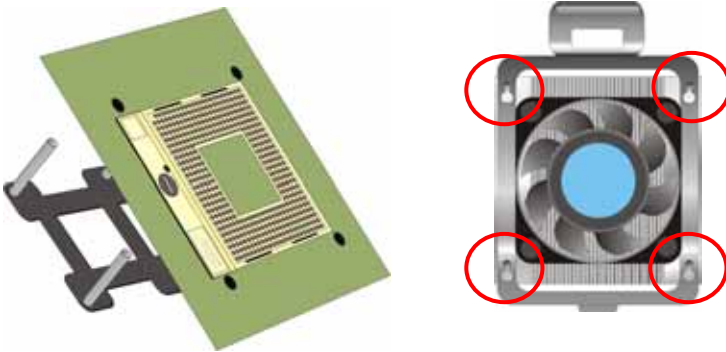

3. Press the both sides of the cooler shield down and push it to move front

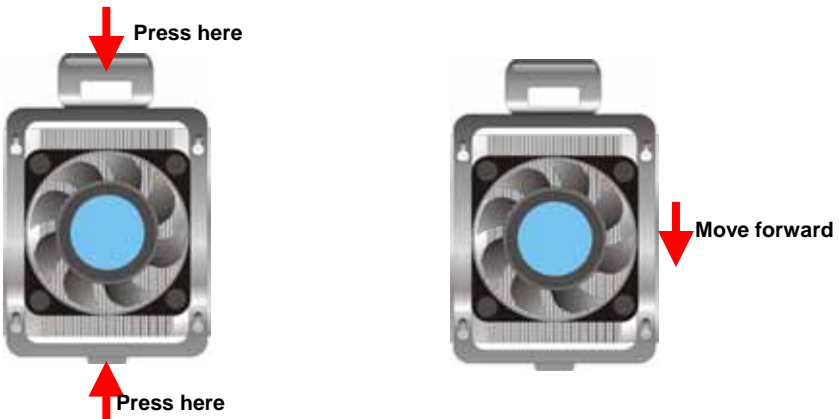

2.4.4 <Complete the system installation>

After installing the CPU, CPU cooler and the memory module, please slot the main board into PICMG slot of the backplane carefully. If you connect an ATX power supply with the backplane, you will need to connect an ATX function cable between the main board and the backplane.

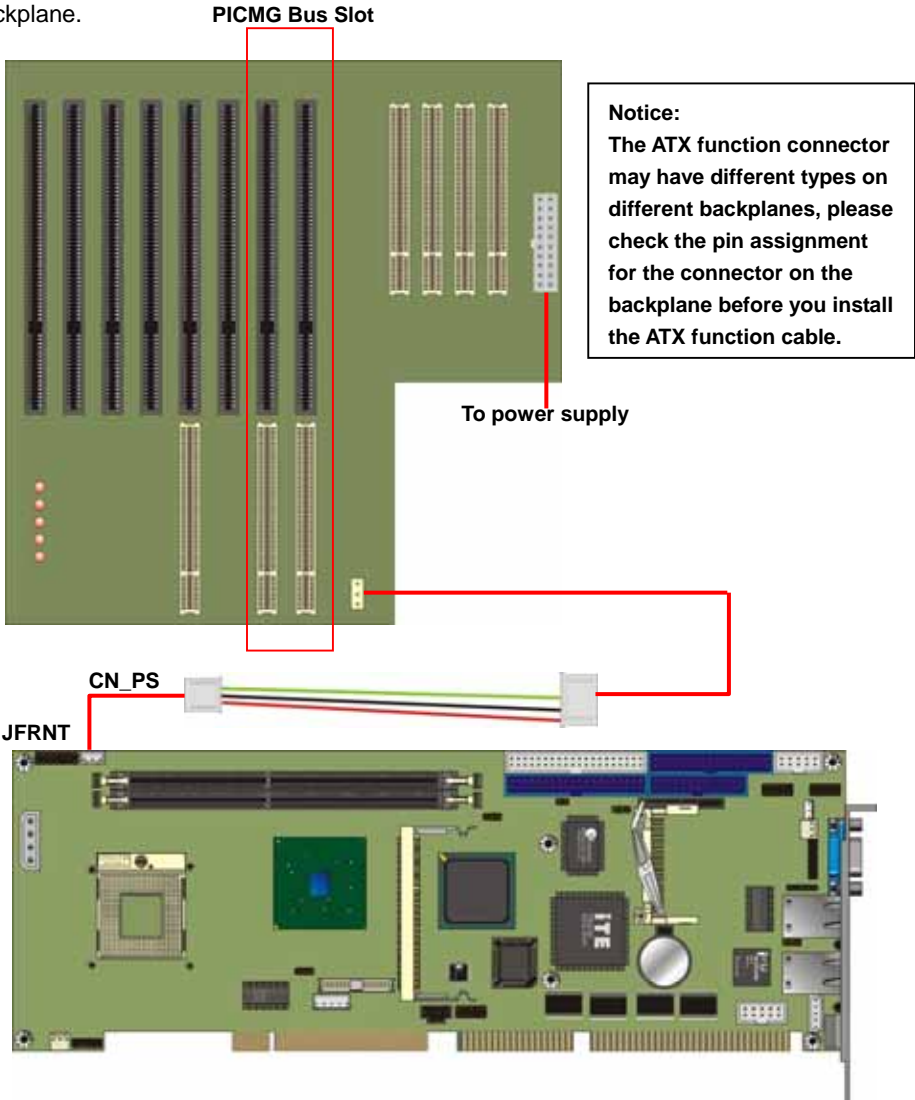

To power on the system, please check chapter 2.13 to short the power button pin on JFRNT.

2.5 <CMOS Setup>

The board's data of CMOS can be setting in BIOS. If the board refuses to boot due to inappropriate CMOS settings, here is how to proceed to clear (reset) the CMOS to its default values.

Jumper: JRTC

Type: Onboard 3-pin jumper

JRTC	Mode
1-2	Clear CMOS
2-3	Normal Operation

Default setting

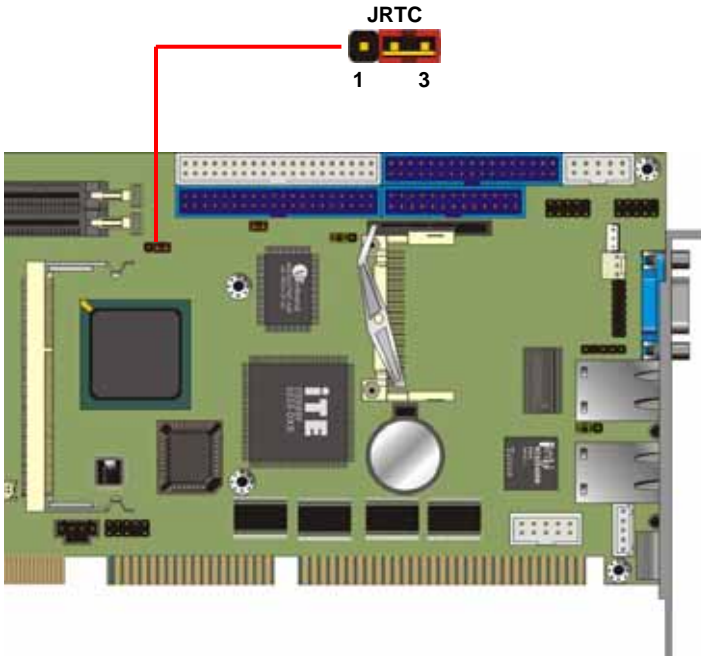

2.6 <Watchdog Timer Setting>

The watchdog timer makes the system auto-reset while it stops to work for a period. The integrated watchdog timer can be setup as system reset mode by program.

Timeout Value Range

- 1 to 255
- Second or Minute

Program Sample

Watchdog timer setup as system reset with 5 second of timeout

```

2E, 87
2E, 87
2E, 07
2F, 08      Logical Device 8
2E, 30      Activate
2F, 01
2E, F5      Set as Second*
2F, 00
2E, F6      Set as 5
2F, 05
    
```

* Minute: bit 3 = 0; Second: bit 3 = 1

You can select Timer setting in the BIOS, after setting the time options, the system will reset according to the period of your selection.



For more specification of watchdog timer program, please check appendix document.

2.7 <Embedded Solid State Disk>

The **FS-97A** supports the IDE-based, bootable and driver free DiskOnModule (DOM) embedded flash disk. The onboard 40-pin IDE1 and 44-pin IDE2 box header supports normal DOM (DiskOnModule) or M-systems DiskOnChip IDE Pro flash disk with or without the additional VCC power cable.

The **FS-97A** also supports Compact Flash Card Type I/II interface. The jumper **JCFSEL** provides you to setup the CF card on master or slave mode.

Jumper: **JCFSEL**

Type: onboard 3-pin header

JCFSEL	Mode
1-2	Master
2-3	Slave

Default setting

Jumper: **JDOM**

Type: onboard 3-pin header

JDOM	Mode
ON	IDE1 pin-20 5V power supply enable
OFF	No 5V power supply on IDE1 pin-20

Default setting

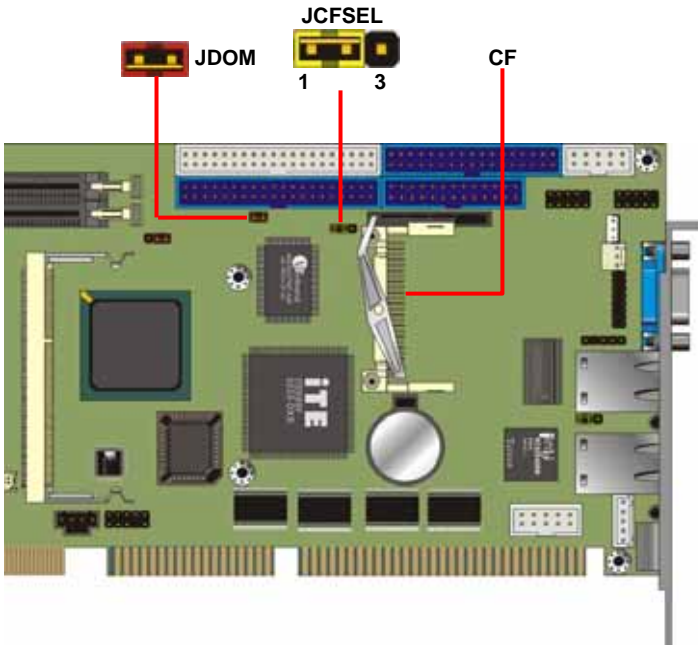

2.8 <Power and Fan Setup>

FS-97A has one 4-pin power input connector expect PICMG bus powering; it also has two fan connectors. For ATX function, you should connect the ATX connector on the backplane with CN_PS on FS-97A.

Connector: **CN_PWR**

Type: 4-pin P-type connector for +5V/+12V input

Pin	Description	Pin	Description	Pin	Description	Pin	Description
1	+12V	2	Ground	3	Ground	4	+5V

Connector: **CPUFAN, SYSFAN**

Type: 3-pin fan wafer connector

Pin	Description	Pin	Description	Pin	Description
1	Ground	2	+12V	3	Fan Control

Connector: **CN_PS**

Type: 3-pin ATX function connector

Pin	Description	Pin	Description	Pin	Description
1	5V Standby	2	Ground	3	Power On

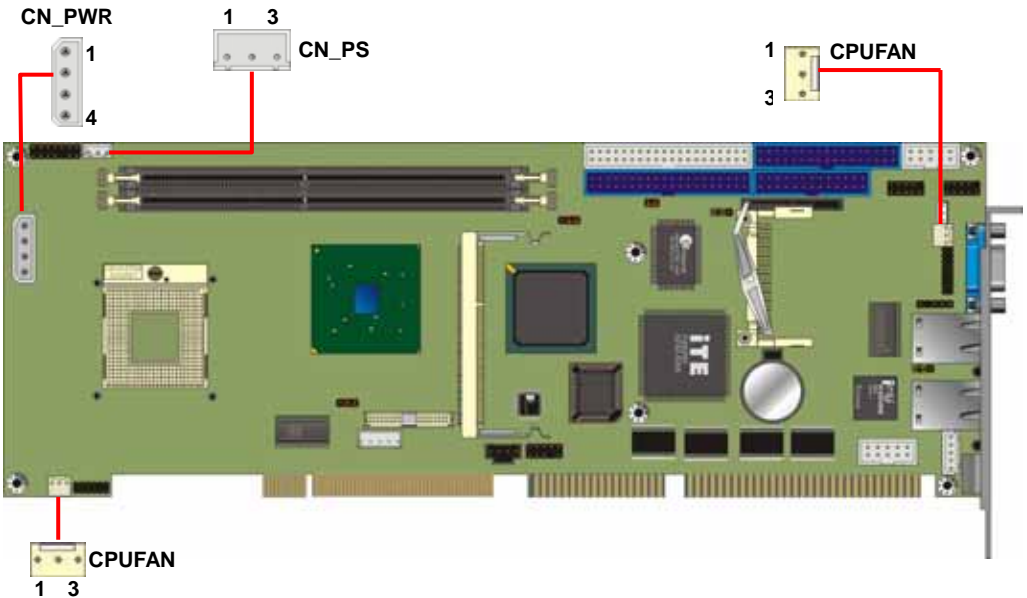

2.9 <Display Interface>

2.9.1 <Analog VGA interface>

The board is integrated with Intel 855GM GMCH chipset built-in Intel Extreme Graphics 2 with 266 MHz VGA core, 256-bit 3D engine and Intel Dynamic Video Memory up to 64MBytes shared with system memory. The CRT / analog VGA interface includes one external DB15 female connector on bracket and one 8 x 2-pin header connector on board.

(The two interfaces can not be used at the same time)

Connector: **CN_VGA**

Type: 16-pin (2 x 8) pin header (pitch = 2.0mm)

Pin	Description	Pin	Description
1	Red	9	Green
2	Blue	10	N/C
3	Ground	11	Ground
4	Ground	12	Ground
5	N/C	13	Ground
6	N/C	14	Data
7	HSYNC	15	VSYNC
8	Clock	16	N/C

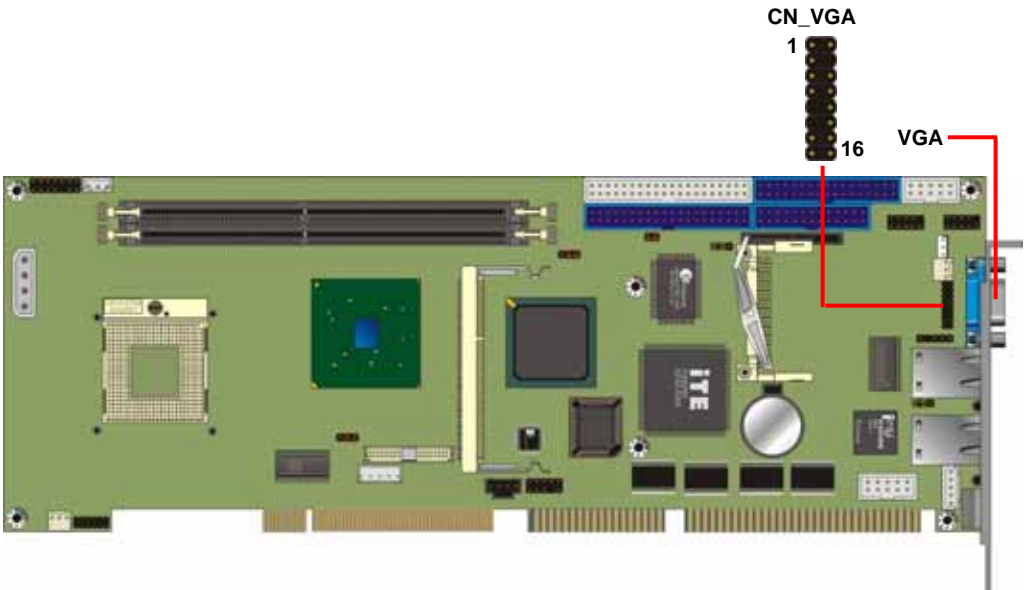

2.9.2 <Digital VGA interface>

The board provides one 20 x 2-pin LVDS interface for LCD panel, it supports 18/24-bit single/dual channel up to 1600 x 1200 of resolution. The jumper **JVLCD** can let you select your panel whether supports +5V or +3.3V of voltage, and the **CN_INV** provides panel inverter interface includes backlight controlling and powering.

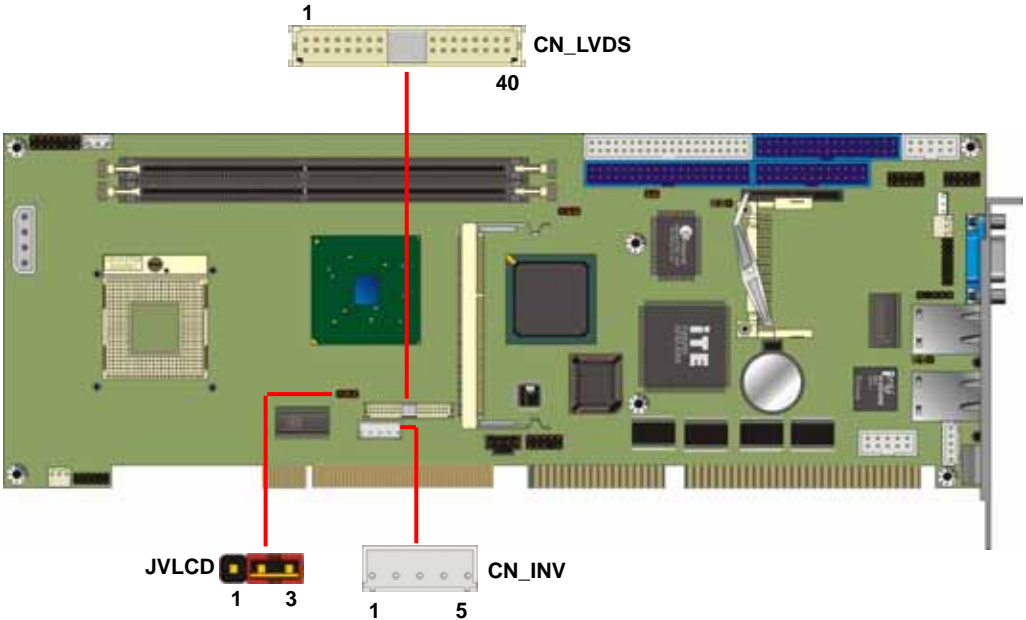

Connector: **CN_INV**

Type: 5-pin LVDS Power Header

Pin	Description
1	+12V
2	GND
3	GND
4	GND
5	ENABKL

Connector: **JVLCD**

Type: 3-pin Power select Header

Pin	Description
1	VCC
2	LCDVCC
3	VCC3

Connector: **CN_LVDS**

Type: onboard 40-pin connector for LVDS connector

Connector model: **HIROSE DF13-40S**

Pin	Signal	Pin	Signal
2	LCDVCC	1	LCDVCC
4	GND	3	GND
6	ATX0-	5	BTX0-
8	ATX0+	7	BTX0+
10	GND	9	GND
12	ATX1-	11	BTX1-
14	ATX1+	13	BTX1+
16	GND	15	GND
18	ATX2-	17	BTX2-
20	ATX2+	19	BTX2+
22	GND	21	GND
24	ATXCK-	23	BTX3-
26	ATXCK+	25	BTX3+
28	GND	27	GND
30	ATX3-	29	BTXCK-
32	ATX3+	31	BTXCK+
34	GND	33	GND
36	PANELCLK	35	N/C
38	PANELDATA	37	N/C
40	N/C	39	N/C

To setup the LCD, you need the components below:

1. A panel (support up to 24-bit dual channel) with LVDS interfaces.
2. An inverter for panel's backlight power.
3. A LCD cable and an inverter cable.

For the cables, please follow the pin assignment of the connector to make a cable, because every panel has its own pin assignment, so we do not provide a standard cable; please find a local cable manufacture to make cables.

LCD installing guide:

1. Prepare a panel, inverter and **FS-97A**.

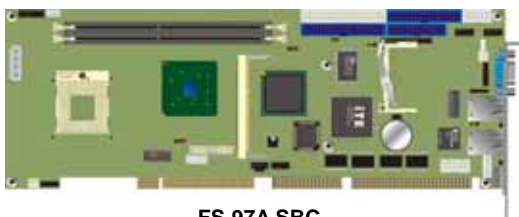

FS-97A SBC



LCD panel



Inverter

2. Please check the datasheet of the panel to see the voltage of the panel, and set the jumper **JVLCD** to +5V or +3.3V.
3. Prepare a LVDS type LCD cable



4. Connect all the devices well.

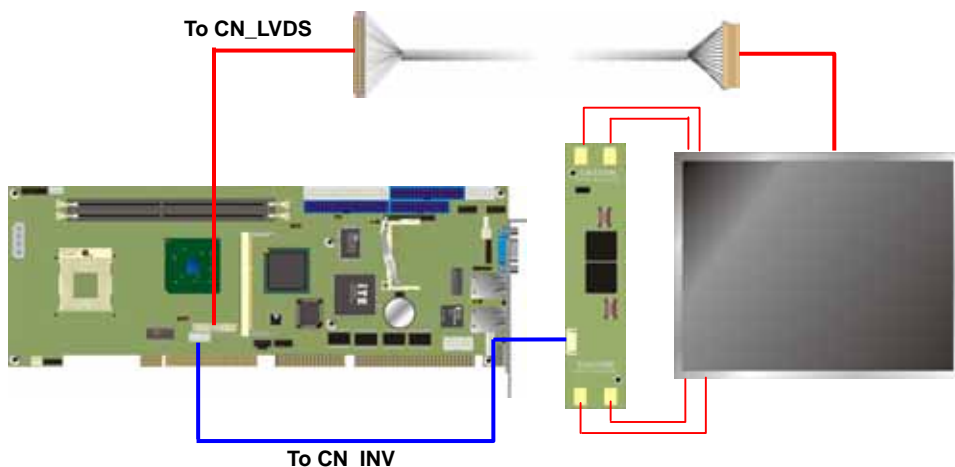

After setup the devices well, you need to select the LCD panel type in the BIOS.

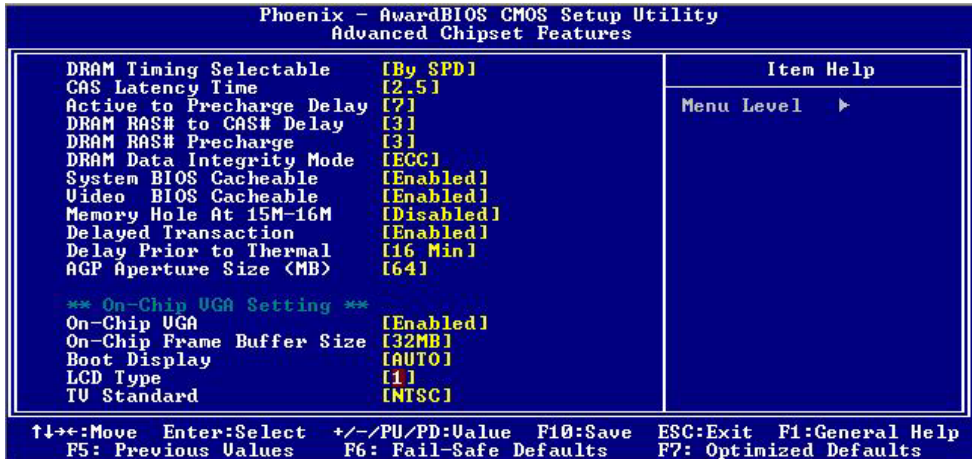

The panel type mapping is list below:

BIOS panel type selection form			
For 18-bit color		For 24-bit color	
NO.	Output format	NO.	Output format
1	640 x 480	8	1024 x 768
2	800 x 600	9	1280 x 1024 Dual Channel
3	1024 x 768	10	1400 x 1050 Dual Channel
4	1280 x 1024	11	1600 x 1200 Dual Channel
5	1400 x 1050 Dual Channel @ 108Mhz	13	1024 x 768 Dual Channel
6	1400 x 1050 Dual Channel @ 122Mhz		
7	1600 x 1200 Dual Channel		
12	1024 x 768 Dual Channel		

2.10 < Ethernet Network Interface >

The **FS-97A** is integrated with one Intel **82562ET** PRO/100+ Ethernet interface at the type of 10Base-T/100Base-TX auto-switching Ethernet with full duplex and IEEE 802.3U compliant. The **optional** secondary Ethernet controller is Intel **82540EM** PRO/1000+ at the type of 10Base-T/100Base-TX/1000Base-T auto-switching Ethernet with full duplex and IEEE 802.3U compliant. The jumper **JLAN** can let you set to enable/disable onboard primary network function.

Connector: **CN_WOL**

Type: onboard 3-pin (1 x 3) wafer connector

Pin	1	2	3
Description	WOL-Ctrl	Ground	+5V Standby

Jumper: **JLAN**

Type: onboard 3-pin header

1-2	Enable Onboard LAN2 controller
2-3	Disable Onboard LAN2 controller

Default setting

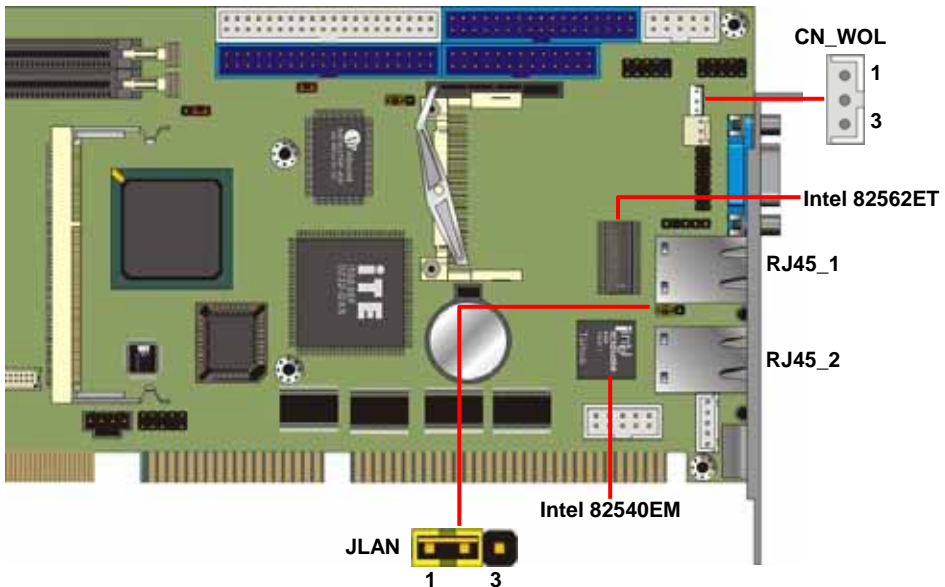

2.11 <Audio Interface>

FS-97A provides a stereo audio interface with Realtek ALC201A AC97 Codec. The **CN_AUDIO** provides the interface to use attached audio cable, the **CDIN** can let you connect audio output from CD-ROM drives.

Connector: CN_AUDIO

Type: 10-pin (2 x 5) 2.54-pitch header

Pin	Description	Pin	Description
1	Line – Right	2	Ground
3	Line – Left	4	MIC
5	MIC	6	Ground
7	N/C	8	Line Out – Left
9	Line Out – Right	10	Ground

Connector: CDIN

Type: 4-pin header

Pin	Description
1	CD – Left
2	Ground
3	Ground
4	CD – Right

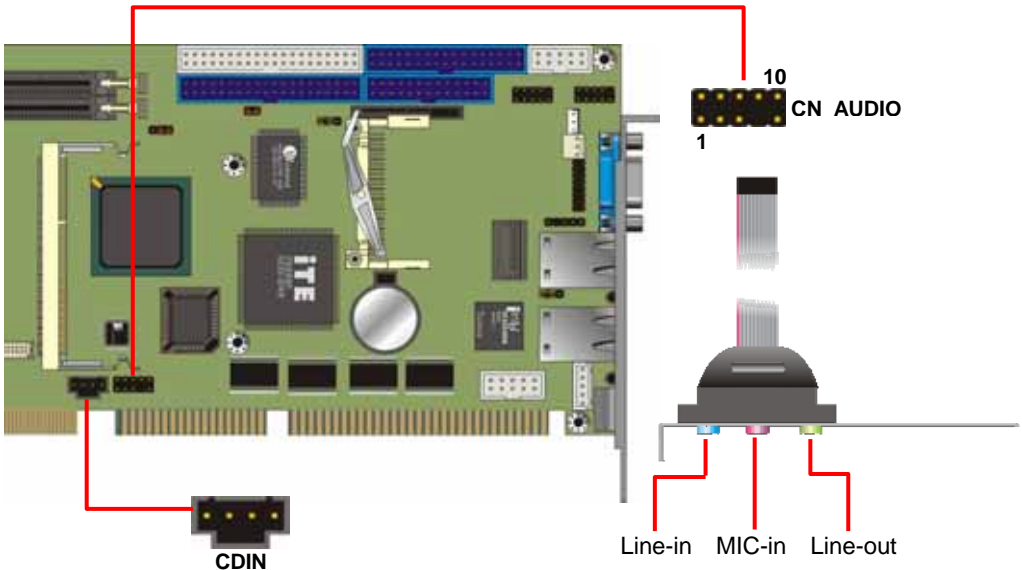

2.12 <GPIO interface>

The board offers 8-bit digital I/O to customize its configuration to your control needs. For example, you may configure the digital I/O to control the opening and closing of the cash drawer or to sense the warning signal from a tripped UPS. The following is a detailed description of how the digital I/O is controlled via software programming.

Connector: **CN_DIO**

Type: 12-pin (6 x 2) header (pitch = 2.0mm)

Pin	Description	Pin	Description
1	Ground	2	Ground
3	LGP0	4	LGP4
5	LGP1	6	LGP5
7	LGP2	8	LGP6
9	LGP3	10	LGP7
11	VCC	12	+12V

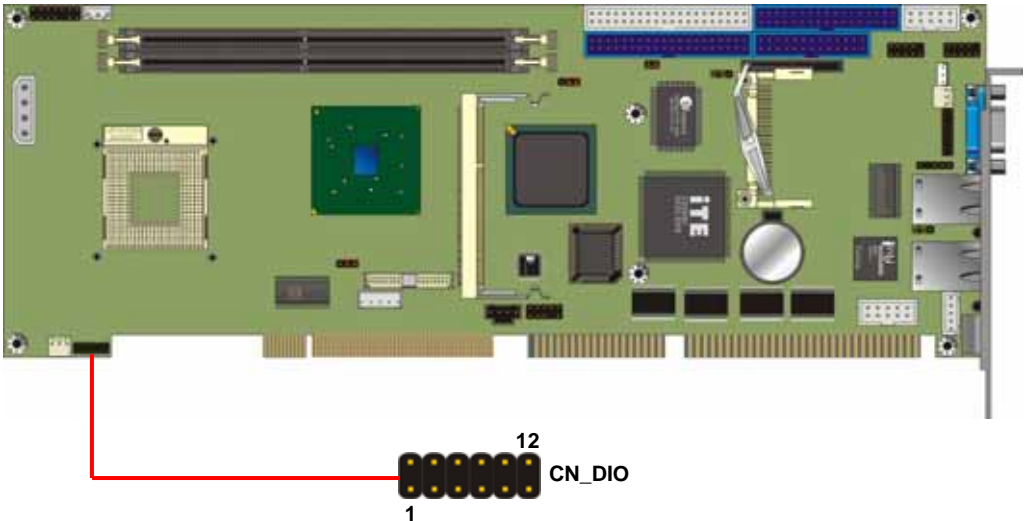

2.13 <Switch and Indicator>

The **JFRNT** provides front control panel of the board, such as power button, reset and beeper, etc.

Connector: **JFRNT**

Type: onboard 14-pin (2 x 7) 2.54-pitch header

Function	Signal	PIN		Signal	Function
IDE LED	VCC(+)	1	2	(+) VCC	Power LED
	Active	3	4	N/C	
Reset	Reset	5	6	GND	Speaker
	GND	7	8	VCC	
N/C		9	10	N/C	
Power Button	PWRBT	11	12	N/C	
	5VSB	13	14	SPKIN	

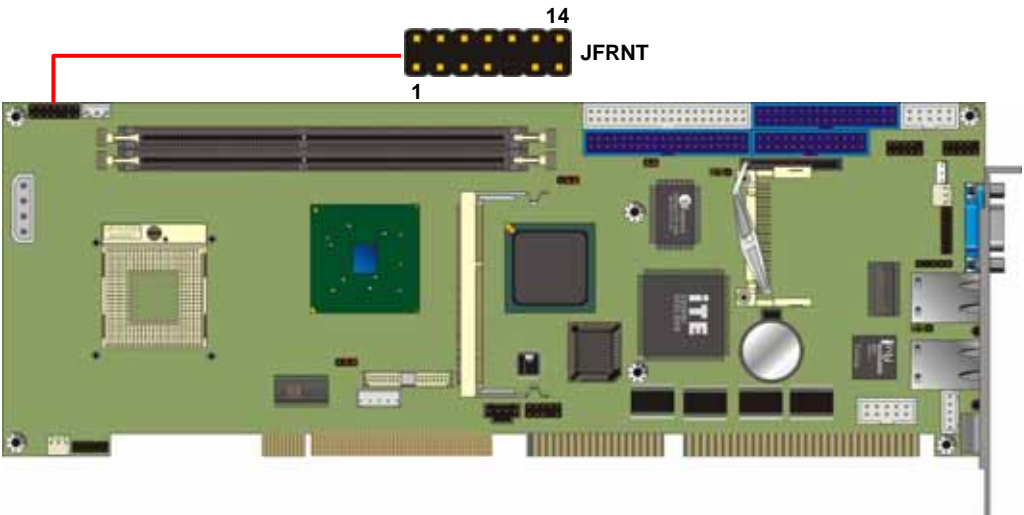

Chapter 3 <Display Mode Setup>

This chapter shows you how to setup the display device under Windows OS.

Before you using your display device:

1. Check your software

Before you can use the display device properly, please install the VGA driver.

2. Check your hardware

Please setup the display device properly before you boot up the system.

For configure your Display device, please follow the instructions below:

1. Please lunch Display Properties.

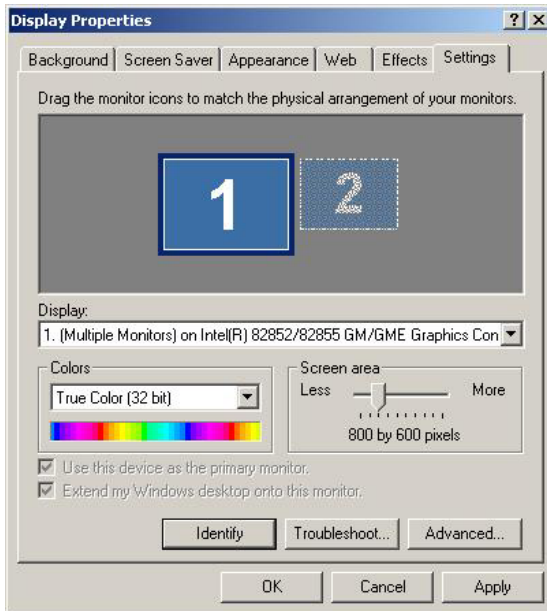

You would see two Graphics Controllers. If you connect two display devices, you would be able to setup each device for color bit and resolution.



This item can let you configure which device would be the primary if you connect two display devices.



This item can let you extend your Windows Desktop to second display device.

If you click the identify button, the screen will pop up the number sequence of your device.

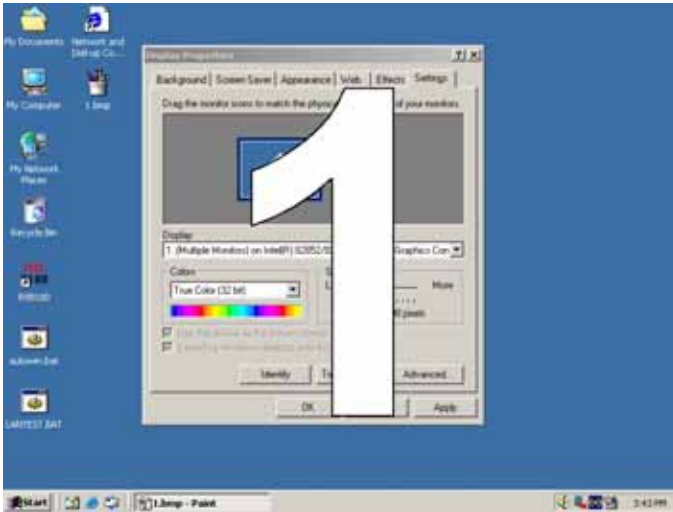

For advanced display settings, please click Advanced... button and choose Intel(R) Extreme Graphics.

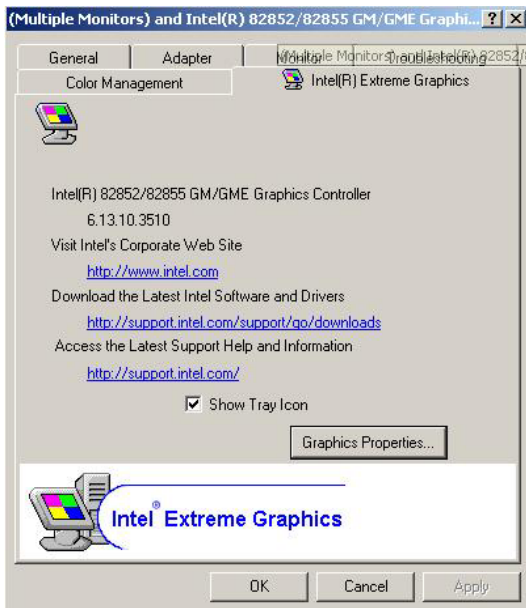

Please click Graphics Properties button to enter the advanced setup.

While you entering the Graphics Properties, you will see the options below:

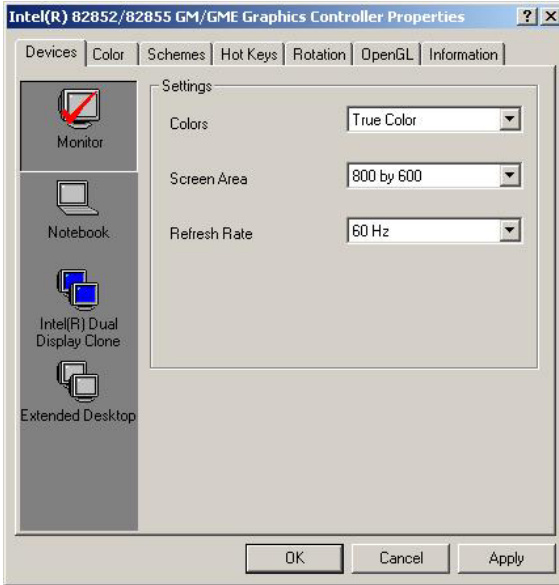

This option can let you configure the CRT monitors for Colors, Screen Area (Resolution) and Refresh Rate.

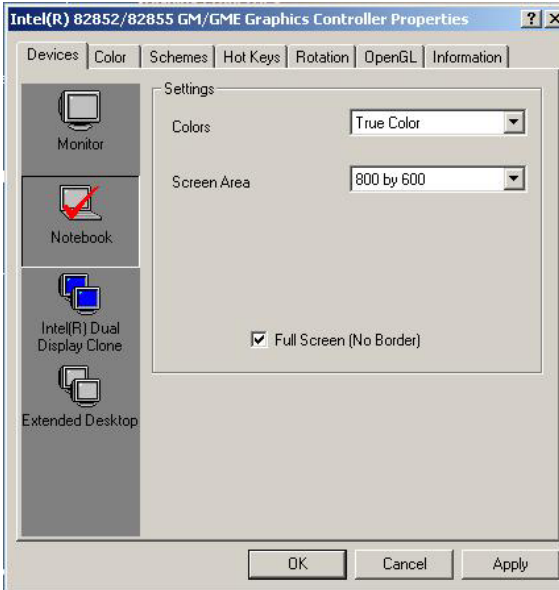

This option can let you configure the LCD panel for Colors, Screen Area (Resolution) and Full Screen option.

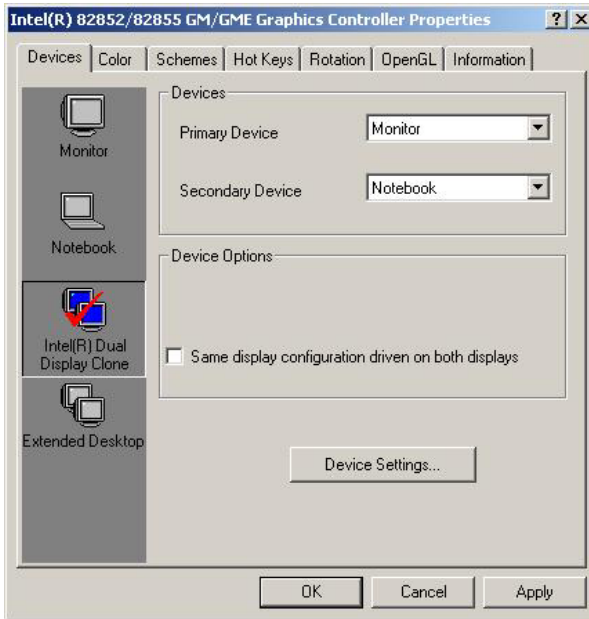

This option can let you configure the Dual Display for clone mode (same display on two devices)

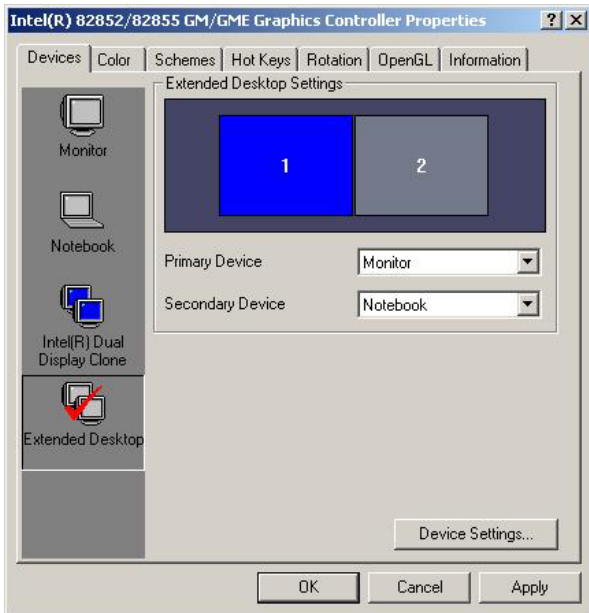

This option can let you configure the Dual Display for Extended Desktop mode

Chapter 4 <BIOS Setup>

The single board computer uses the Award BIOS for the system configuration. The Award BIOS in the single board computer is a customized version of the industrial standard BIOS for IBM PC AT-compatible computers. It supports Intel x86 and compatible CPU architecture based processors and computers. The BIOS provides critical low-level support for the system central processing, memory and I/O sub-systems.

The BIOS setup program of the single board computer let the customers modify the basic configuration setting. The settings are stored in a dedicated battery-backed memory, NVRAM, retains the information when the power is turned off. If the battery runs out of the power, then the settings of BIOS will come back to the default setting.

The BIOS section of the manual is subject to change without notice and is provided here for reference purpose only. The settings and configurations of the BIOS are current at the time of print, and therefore they may not be exactly the same as that displayed on your screen.

To activate CMOS Setup program, press key immediately after you turn on the system. The following message "Press DEL to enter SETUP" should appear in the lower left hand corner of your screen. When you enter the CMOS Setup Utility, the Main Menu will be displayed as **Figure 5-1**. You can use arrow keys to select your function, press <Enter> key to accept the selection and enter the sub-menu.

Figure 5-1 CMOS Setup Utility Main Screen

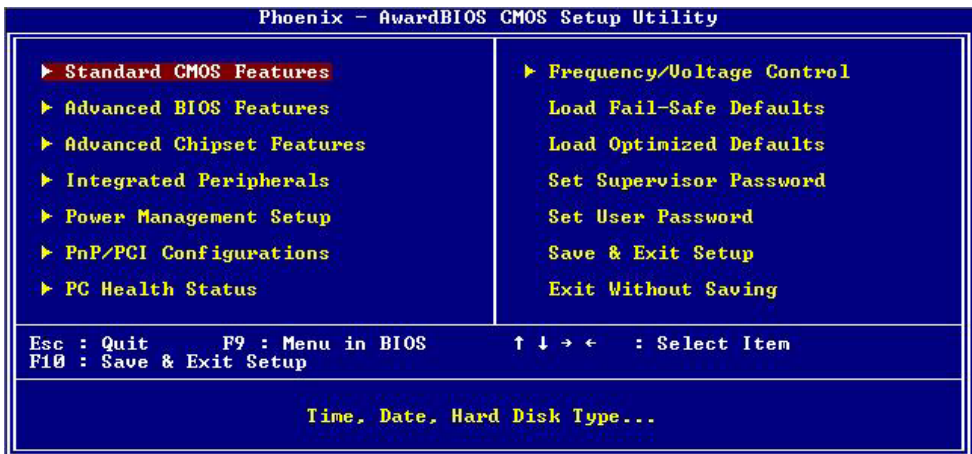

(This Page is Left for Blank)

(This Page is Left for Blank)

Appendix A <I/O ports pin assignment>

A.1 <IDE Port>

Connector: **IDE1/2**

Type: 40-pin (20 x 2) box header



Pin	Description	Pin	Description
1	Reset	2	Ground
3	D7	4	D8
5	D6	6	D9
7	D5	8	D10
9	D4	10	D11
11	D3	12	D12
13	D2	14	D13
15	D1	16	D14
17	D0	18	D15
19	Ground	20	VCC
21	REQ	22	Ground
23	IOW-/STOP	24	Ground
25	IOR-/HDMARDY	26	Ground
27	IRDY/DDMARDY	28	IDESEL
29	DACK-	30	Ground
31	IRQ	32	N/C
33	A1	34	CBLID
35	A0	36	A2
37	CS0 (MASTER CS)	38	CS1 (SLAVE CS)
39	LED ACT-	40	Ground

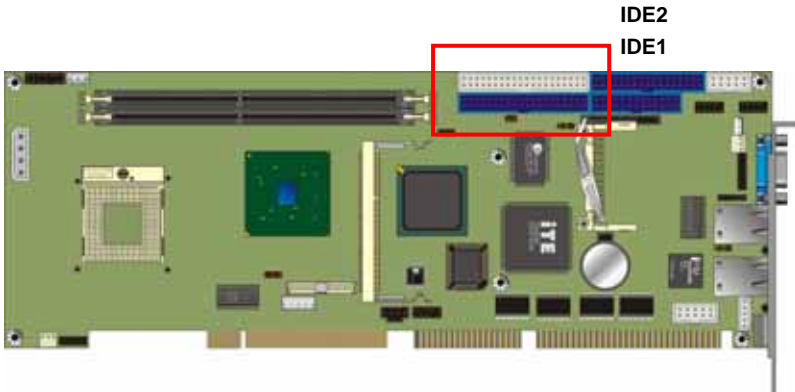

A.2 <Floppy Port>

Connector: **FDD**

Type: 34-pin (2 x 17) 2.54-pitch header



Pin	Description	Pin	Description
1	Ground	2	DRIVE DENSITY SELECT 0
3	Ground	4	DRIVE DENSITY SELECT 1
5	Ground	6	N/C
7	Ground	8	INDEX-
9	Ground	10	MOTOR ENABLE A-
11	Ground	12	DRIVER SELECT B-
13	Ground	14	DRIVER SELECT A-
15	Ground	16	MOTOR ENABLE B-
17	Ground	18	DIRECTION-
19	Ground	20	STEP-
21	Ground	22	WRITE DATA-
23	Ground	24	WRITE GATE-
25	Ground	26	TRACK 0-
27	Ground	28	WRITE PROTECT-
29	Ground	30	READ DATA-
31	Ground	32	HEAD SELECT-
33	Ground	34	DISK CHANGE-

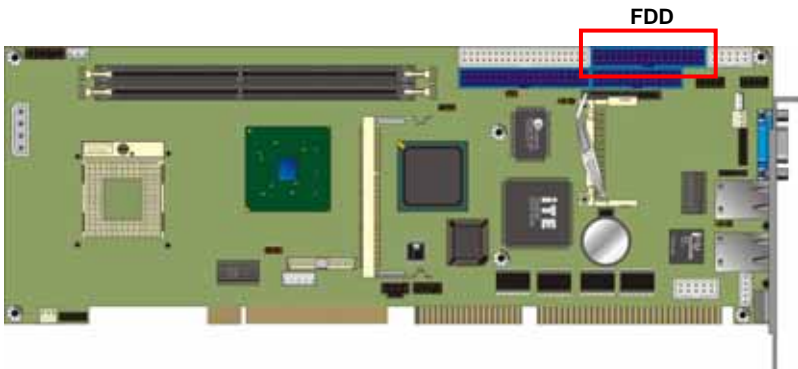

A.3 < Parallel Port >

Connector: **CN_LPT**

Type: 26-pin (2 x 13) 2.54-pitch box header



Pin	Description	Pin	Description
1	STROBE-	14	AUTO FEED-
2	D0	15	ERROR-
3	D1	16	INITIALIZE-
4	D2	17	SELECT INPUT-
5	D3	18	Ground
6	D4	19	Ground
7	D5	20	Ground
8	D6	21	Ground
9	D7	22	Ground
10	ACKNOWLEDGE-	23	Ground
11	BUSY	24	Ground
12	PAPER EMPTY	25	Ground
13	SELECT+	26	N/C

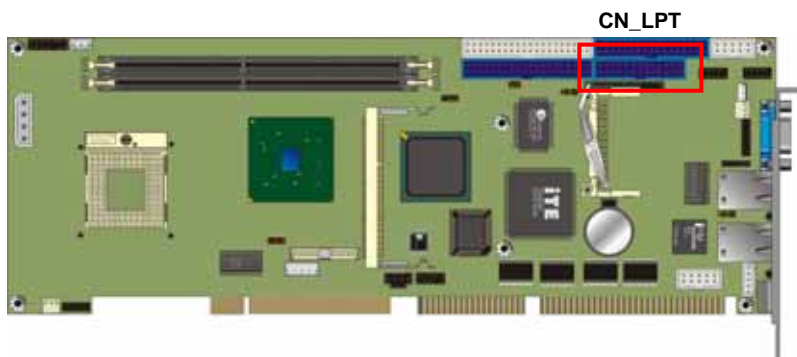

A.4 <Serial Port>

A.4.1 <External DB9 COM>

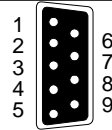

Connector: **COM1**

Type: 9-pin D-sub male connector on bracket

Pin	Description	Pin	Description
1	DCD	6	DSR
2	SIN	7	RTS
3	SO	8	CTS
4	DTR	9	RI
5	Ground		

A.4.2 <Internal COM2>



Connector: **CN_COM2**

Type: 10-pin (2 x 5) 2.54-pitch header

Pin	Description	Pin	Description
1	DCD	2	SIN
3	SO	4	DTR
5	Ground	6	DSR
7	RTS	8	CTS
9	RI	10	N/C

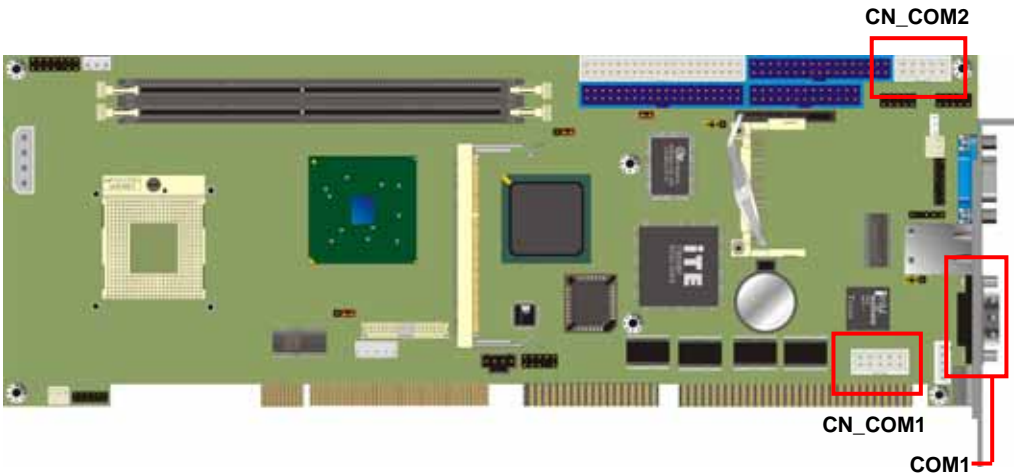

A.5 <USB Port>

Connector: **CN_USB1, CN_USB2**

Type: 10-pin (2 x 5) header for dual USB Ports

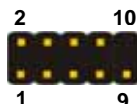

Pin	Description	Pin	Description
1	VCC	2	VCC
3	Data0-	4	Data1-
5	Data0+	6	Data1+
7	Ground	8	Ground
9	Ground	10	N/C

CN_USB1 CN_USB2

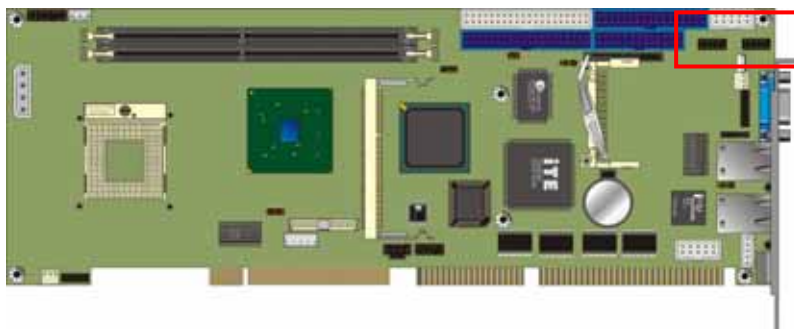

A.6 <IrDA Port>

Connector: **CN_IR**

Type: 5-pin (1 x 5) 2.54-pitch header for SIR Port



Pin	Description
1	VCC
2	N/C
3	IRRXD
4	Ground
5	IRTXD

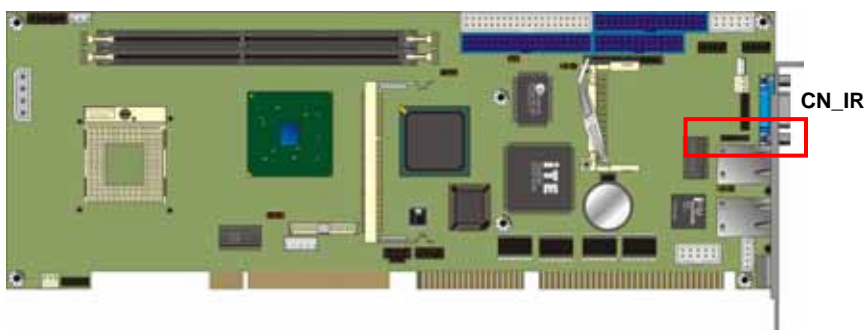

A.7 <VGA Port>

Connector: **VGA**

Type: 15-pin D-sub female connector on bracket

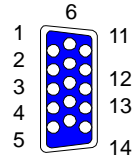

Pin	Description	Pin	Description	Pin	Description
1	RED	6	Ground	11	N/C
2	GREEN	7	Ground	12	5VCDA
3	BLUE	8	Ground	13	HSYNC
4	N/C	9	LVGA5V	14	VSYNC
5	Ground	10	Ground	15	5VCLK

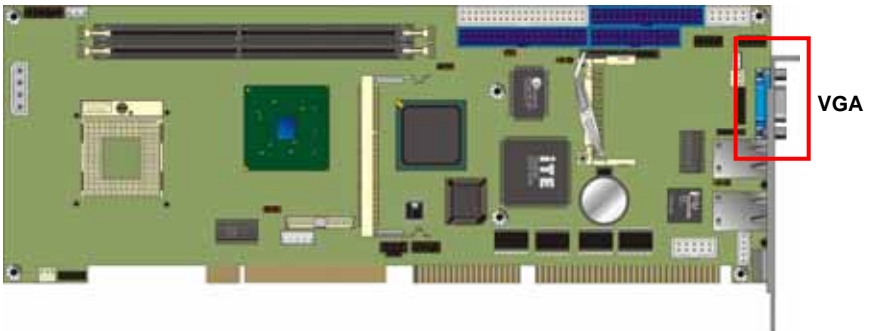

A.8 <LAN Port>

A.8.1 < Fast Ethernet>

Connector: **RJ45_1**

Type: RJ45 connector with LED on bracket

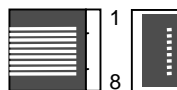

Pin	1	2	3	4	5	6	7	8
Description	TX+	TX-	RX+	N/C	N/C	RX-	N/C	N/C

A.8.2 <Gigabit Ethernet >

Connector: **RJ45_2 (97AVL2 Only)**

Type: RJ45 connector with LED on bracket

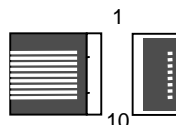

Pin	1	2	3	4	5
Description	TRD0+	TRD0-	TRD1+	TRD1-	NC

Pin	6	7	8	9	10
Description	NC	TRD2+	TRD2-	TRD3+	TRD3-

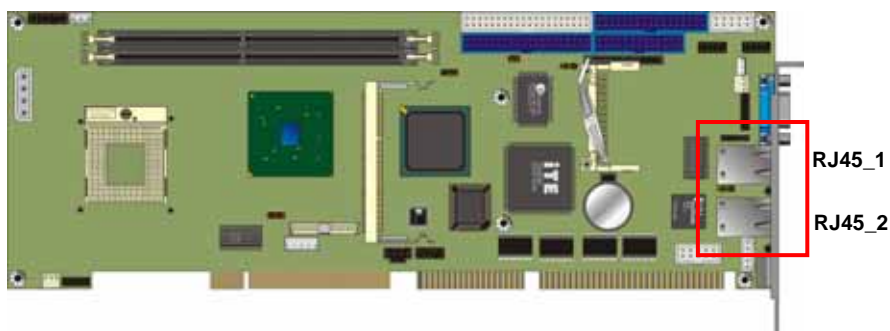

A.9 <AT Keyboard Port>

Connector: **CN_ATKB**

Type: 5-pin box header

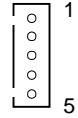

Pin	1	2	3	4	5
Description	VCC	Ground	N/C	DATA	CLK

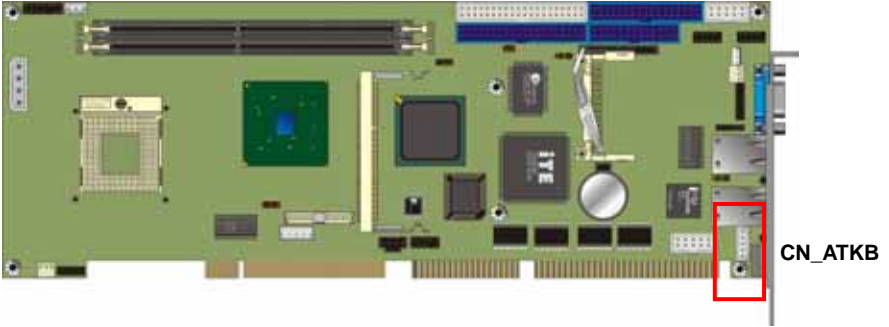

A.10 <PS/2 Keyboard & Mouse Port>

Connector: **PS2**

Type: 6-pin Mini-DIN connector on bracket

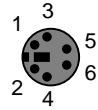

Pin	1	2	3	4	5	6
Description	KBD	MSD	Ground	VCC	KBC	MSC

Note: The PS/2 connector supports standard PS/2 keyboard directly or both PS/2 keyboard and mouse through the PS/2 Y-type cable.

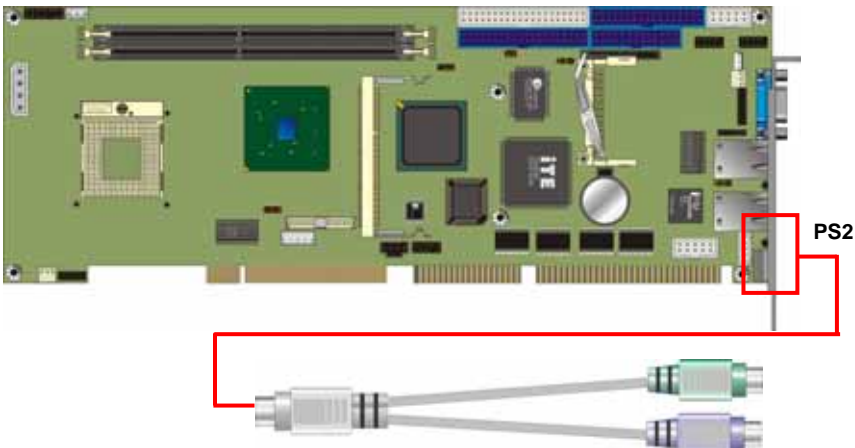

Appendix B <Flash BIOS>

B.1 BIOS Auto Flash Tool

The board is based on Award BIOS and can be updated easily by the BIOS auto flash tool. You can download the tool online at the address below:

<http://www.award.com>

<http://www.commell.com.tw/support/support.htm>

File name of the tool is "awdf flash.exe", it's the utility that can write the data into the BIOS flash chip and update the BIOS.

B.2 Flash Method

1. Please make a bootable floppy disk.
2. Get the last .bin files you want to update and copy it into the disk.
3. Copy awardflash.exe to the disk.
4. Power on the system and flash the BIOS. (Example: C:/ awardflash XXX.bin)
5. Re-start the system.

Any question about the BIOS re-flash please contact your distributors or visit the web-site at below:

<http://www.commell.com.tw/support/support.htm>

(This Page is Left for Blank)

(This Page is Left for Blank)

Appendix C <Watchdog Timer Programming Guide>

WDT source from : WinBond 83627HF

(1) General Description

Winbond has a WDT feature inside its chip. We implement its function into our circuit .

There are many configuration Registers (CR) in 83627HF. The following sequence must be followed for CR programming :

- (*1) Enter the extended function mode
- (*2) Configure the configuration registers
- (*3) Exit the extended function mode

EFER : Extended Function Enable Registers.(EFER=2Eh in our system)

EFIR : Extended Function Index Register. (Same addr. with EFER.)

EFDR : Extended Function Data Register.(Located at addr.[EFIR +1])

For instance ;

(*1) Enter extended function mode

```
MOV DX,2EH
MOV AL,87H
CLI           ; disable interrupt
OUT DX,AL
JMP $+2
OUT DX,AL
STI           ; enable interrupt
```

(*2) Configure logical device 1 , configuration register CRF0

```
MOV DX,2EH
MOV AL,07H
OUT DX,AL
           ; point to Logical Device Number Register
MOV DX,2FH
MOV AL,01H
OUT DX,AL
           ; select logical device 1
MOV DX,2EH
MOV AL,0F0H
OUT DX,AL
MOV DX,2FH
MOV AL,3CH
OUT DX,AL ; update CRF0 of LD0 with value 3Ch
```

(*3) Exit extended function mode

```
MOV DX,2EH
MOV AL,0AAH
OUT DX,AL
```

The Configuration Register (CR) Definition :

- ** Chip (Global) Control Register (CCR) : CR02 -->CR2F.
CR07 = Logical Device Number Register (LDNR)
- ** Logical Device 0 (LD0) = FDC , with CR : CR30 -->CRF5 .
When LDNR (= CR07) = 00h , you can program the CR30 -->CRF5 related to FDC feature .
- ** Logical Device 1 (LD1) = Parallel Port,with CR :CR30 -->CRF0.
- ** LD2 = UART A (Serial Port 1) ,with CR :CR30 -->CRF0.
- ** LD3 = UART B (Serial Port 2) ,with CR :CR30 -->CRF1.
- ** LD5 = KBC ,with CR :CR30 -->CRF0.
- ** LD6 = CIR ,with CR :CR30 -->CR70.
- ** LD7 = GAME PORT,MIDI PORT & GP I/O Port I,with CR :CR30 -->CRF2.
- ** LD8 = GP I/O Port II,with CR :CR30 -->CRF7.
- ** LD9 = GP I/O Port III,with CR :CR30 -->CRF3.
- ** LDA = ACPI,with CR :CR30 -->CRFF.
- ** LDB = HARDWARE MONITOR, with CR : CR30 --> CRF0

(2) Related CR for WDT programming

CR2B-Bit 4 ; [0] for WDT function (via Pin89)

LD8-CRF5-Bit 3; Select WDT count time

0 = second.

1 = minute.

LD8-CRF6 ; WDT time-out period ,

00h = disabled

01h = 1 second/minute .

02h = 2 seconds/minutes .

03h = 3 seconds/minutes .

04h = 4 seconds/minutes .

05h = 5 seconds/minutes .

.....

FEh = 254 seconds/minutes .

FFh = 255 seconds/minutes .

When writing a non-zero value to LD8-CRF6 , this value will be loaded into WDT counter and start to count down .Read this register can not get the WDT time-out period (the original one written into) , but the current value in WDT counter .

Enable and Refresh WDT : program LD8-CRF6 a non-zero value .

Disable WDT : program LD8-CRF2 with 00h .

LD8-CRF7- Bit 4 : WDT Status

1 = WDT time-out happened

0 = WDT counting .

LD8-CRF7- Bit[3..0] : Select IRQ resource for WDT time-out

(Setting of 2 selects SMI)

(3) WDT Programming guide

Step 1 . Enter extended function mode as mentioned as above.

Step 2 . Program WDT related CR.

(2-1) CR2B-b[4]P[0] ; Set pin output as WDT function

(2-2) CR07-P08h ; Point to LD8

(2-3) CRF6-Pxyh

; Program WDT time-out period and start

count down . xy = 00 ; No WDT time-out and counting

xy = 01 ; WDT time-out = 30 sec. and starts counting .

.....

(2-4) Read CRF7-b4 if needed ; 0 : WDT counting

1 : WDT time-out happened

Step 3. Exit extended function mode as mentioned as above.

Example (ENABLE WDT AND SET WDT time-out = 5 minutes)

Step 1 .

```
MOV DX,2EH
```

```
MOV AL,87H
```

```
CLI ; disable interrupt
```

```
OUT DX,AL
```

```
JMP $+2
```

```
OUT DX,AL
```

```
STI ; enable interrupt
```

Step 2 .

```
MOV DX,2Eh
```

```
MOV AL,2BH
```

```
OUT DX,AL
```

```
MOV DX,2Fh
```

```
IN AL,DX ; READ CR2B
```

```
AND AL,0EFH
```

```
MOV AH,AL
```

```
MOV DX,2Eh
```

```
MOV AL,2BH
```

```
OUT DX,AL
```

```
MOV DX,2Fh
```

```
MOV AL,AH
```

```
OUT DX,AL ; CR2B-b[4]P[0]
```

```
MOV DX,2Eh
```

```
MOV AL,07H
```

```
OUT DX,AL ; point to Logical Device Number Register
```

```

MOV DX,2Fh
MOV AL,08H
OUT DX,AL ; select logical device 8
;
MOV DX,2Eh
MOV AL,0F5H
OUT DX,AL
MOV DX,2Fh
IN AL,DX ;
OR AL,08h ; SELECT MINUTE
MOV AH,AL

```

```

MOV DX,2Eh
MOV AL,0F5h
OUT DX,AL
MOV DX,2Fh
MOV AL,AH
OUT DX,AL

```

```

MOV DX,2Eh ; SETTING 5 MINUTES
MOV AL,0F6h ; ( LD8-CRF6-P05h )
OUT DX,AL
MOV DX,2Fh
MOV AL,05h
OUT DX,AL

```

Step 3 . Exit extended function mode

```

MOV DX,2Eh
MOV AL,0AAH
OUT DX,AL

```

REMARK :

**** I/O PORT 2Eh --> Index port for programming CR .

2Fh --> Data port for programming CR .

**** LD8-CRF6-P05h :

Program CR index F6h of Logical Device 8
with the value "05h" .

Contact Information

Any advice or comment about our products and service, or anything we can help you please don't hesitate to contact with us. We will do our best to support you for your products, projects and business.

Taiwan Commate Computer Inc.

Address	8F, No. 94, Sec. 1, Shin Tai Wu Rd., Shi Chih Taipei Hsien, Taiwan
TEL	+886-2-26963909
FAX	+886-2-26963911
Website	http://www.commell.com.tw
E-Mail	info@commell.com.tw (General Information) tech@commell.com.tw (Technical Support)

Commell is our trademark of industrial PC division