

HS-771

Half-size PCI CPU Card

User's Manual

Edition 1.2
2015/10/15

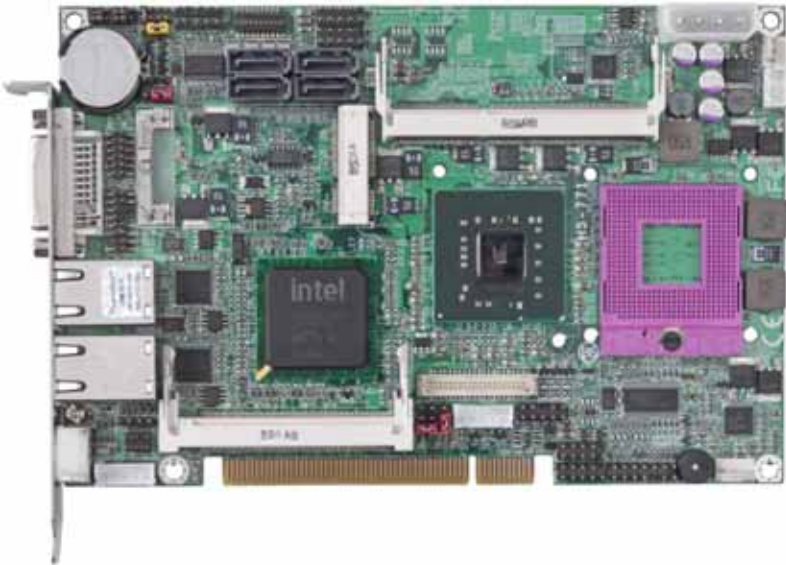

Copyright

Copyright 2009, all rights reserved. This document is copyrighted and all rights are reserved. The information in this document is subject to change without prior notice to make improvements to the products.

This document contains proprietary information and protected by copyright. No part of this document may be reproduced, copied, or translated in any form or any means without prior written permission of the manufacturer.

All trademarks and/or registered trademarks contains in this document are property of their respective owners.

Disclaimer

The company shall not be liable for any incidental or consequential damages resulting from the performance or use of this product.

The company does not issue a warranty of any kind, express or implied, including without limitation implied warranties of merchantability or fitness for a particular purpose.

The company has the right to revise the manual or include changes in the specifications of the product described within it at any time without notice and without obligation to notify any person of such revision or changes.

Trademark

All trademarks are the property of their respective holders.

Any questions please visit our website at <http://www.commell.com.tw>

Packing List:

Please check the package content before you starting using the board.

Hardware:

HS-771 Half-size PCI CPU Card x 1

Cable Kit:



SATA Cable x 2



4-pin to 3-pin ATX cable x 1



PS2 Keyboard / Mouse Y-cable x 1



DVI VGA Cable x 1

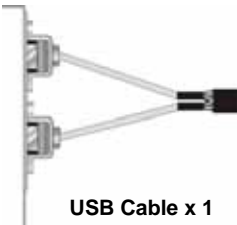

USB Cable x 1

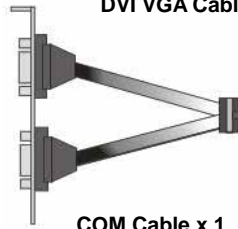

COM Cable x 1



CPU Cooler x 1



AUDIO Cable x 1



YPbPr Cable (Optional)(1040149)

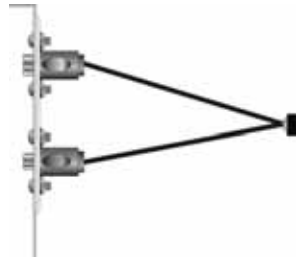

SDTV Cable (Optional)(1040146)

Printed Matters:

Driver CD x 1 (Including User's Manual)

Index

Chapter 1 <Introduction>	6
1.1 <Product Overview>	6
1.2 <Product Specification>.....	7
1.3 <Mechanical Drawing>.....	8
1.4 <Block Diagram>.....	9
Chapter 2 <Hardware Setup>	10
2.1 <Connector Location>	10
2.2 <Jumper Location & Reference>.....	11
2.2.1 <CMOS Setup>	12
2.2.2 <JAT Setup>	12
2.3 <Connector Reference>	13
2.3.1 <Internal Connectors>	13
2.3.2 <External Connectors>	13
2.4 <CPU and Memory Setup>	14
2.4.1 <CPU Setup>.....	14
2.4.2 <Memory Setup>	15
2.5 <Serial ATA Interface>	16
2.6 <Ethernet Interface>.....	17
2.6.1 <LAN Port>	17
2.7 <Onboard Display Interface>	18
2.7.1 <Analog Display>.....	18
2.7.2 <Digital Display>	19
2.7.2 <HDTV Interface>.....	23
2.8 <Integrated Audio Interface>	25
2.9 <GPIO Interface>	26
2.10 <Power Supply>	27
2.10.1 <Power Input>	27
2.11 <Switch and Indicator>	28
2.12 <Serial Port>	29

2.13 <USB Ports>	31
2.14 <Keyboard & Mouse Port>	32
2.14.1 <PS2 Port>	32
2.14.2 <ATKB Port>	32
2.15 <PCI Express Mini Card>.....	33
2.16 <Mini PCI Interface>	33
Chapter 3 <System Setup>	34
3.1 <Audio Configuration>	34
3.2 <Display Properties Setting>.....	35
Chapter 4 <BIOS Setup>	37
Appendix A <I/O Port Pin Assignment>.....	39
A.1 <SMBUS Port>	39
A.2 <IrDA Port>	39
Appendix B <Flash BIOS>	40
B.1 <Flash Tool>	40
B.2 <Flash BIOS Procedure>	40
Appendix C <System Resources>	41
C.1 <Direct memory access (DMA)>	41
C.2 <Input/Output (IO)>	41
C.3 <Interrupt request (IRQ)>	43
C.4 <Memory>	44
Appendix D <Programming GPIO's>	45
Appendix E <Programming Watchdog Timer>	46
Contact Information	47

(This page is left for blank)

Chapter 1 <Introduction>

1.1 <Product Overview>

HS-771, the new generation of the Half-size PCI CPU Card, supports Intel Penryn Processor for 667/800/1066 MHz front side bus and features Intel GM45 and ICH9M chipset, integrated GMA 4500MHD graphics up to 1024MB shared with system memory, DDR3 memory, REALTEK High Definition Audio, Serial ATA and two Intel Gigabit LAN.

Intel Penryn Processor

The board supports Intel Penryn Processors with 667/800/1066 MHz front side bus, 6MB L2 cache, to provide more powerful performance than before.

New features for Intel GM45 chipset

The board integrates Intel GM45 and ICH9M chipset, to provide new generation of the mobile solution, supports Intel GMA 4500MHD graphics up to 1024MB shared with system memory, DDR3 800/1066 MHz memory, built-in high speed mass storage interface of serial ATA, High Definition Audio with 2 channels surrounding sound.

All in One multimedia solution

Based on Intel GM45 and ICH9M chipset, the board provides high performance onboard graphics, 18/24-bit dual channel LVDS interface, DVI, HDTV and 2 channels High Definition Audio, to meet the very requirement of the multimedia application.

Flexible Extension Interface

The board provides one mini-PCI socket and one PCI Express Mini card.

1.2 <Product Specification>

General Specification

Form Factor	Half-size PCI Bus CPU Card
CPU	Support Intel Penryn Processor Package type: Micro-FCPGA478 (Socket-P) Front side bus: 667/800/1066 MHz
Memory	2 x DDRIII SO-DIMM 800/1066 up to 8GB
Chipset	Intel GM45 & ICH9M
Real Time Clock	Chipset integrated RTC with onboard lithium battery
Watchdog Timer	Generates a system reset with internal timer for 1min/s ~255min/s
Power Management	ACPI 2.0 compliant, supports power saving mode
Serial ATA Interface	4 x serial ATAII interface with 300MB/s transfer rate
VGA Interface	Intel integrated extreme GMA 4500MHD (Graphic Media Accelerator) Technology
Video Memory	Up to 1024MB shared with system memory
LVDS interface	Onboard 18/24-bit dual channel LVDS connector with +3.3V/+5V/+12V supply
Audio Interface	Intel integrated ICH9M with Realtek HD Audio codec
LAN Interface	2 x Intel 82574L Gigabit Ethernet
GPIO interface	Onboard programmable 8-bit Digital I/O interface
Extended Interface	1 x PCI express Mini card and 1 x Mini PCI socket
Internal I/O Port	1 x RS232/422/485, 1 x RS232, 1 x ATKB, 1 x SMBUS, 1 x GPIO, 1 x HDTV, 8 x USB ports, 1 x IrDA, 1 x LVDS, 4 x Serial ATA, 1 x LCD inverter, 1 x Front panel Audio, 1 x CDIN and 1 x VGA
External I/O Port	2 x RJ45 LAN ports, 1 x DVI-I port and 1 x PS/2 Keyboard/Mouse Port
Power Requirement	DC 5V/12V power required, optional 5VSB for ATX Onboard 4-pin power connector & 3-pin ATX connector
Dimension	185mm x 122mm (L x W)
Temperature	Operating within 0~60 centigrade Storage within -20~85 centigrade

Ordering Code

HS-771	Onboard VGA, LVDS, DVI-I, LAN, USB2.0, HD Audio, SATA, HDTV, SMBUS, Mini PCI and PCI Express mini card
MPX-574D	PCI Express mini card supports single Giga LAN
MPX-574D2	PCI Express mini card supports dual Giga LAN
ADP-L2T	18bit LVDS to TTL module
CBP-5P4	Support 4 X PCI slots backplane

For further product information please visit the website at <http://www.commell.com.tw>

1.3 <Mechanical Drawing>

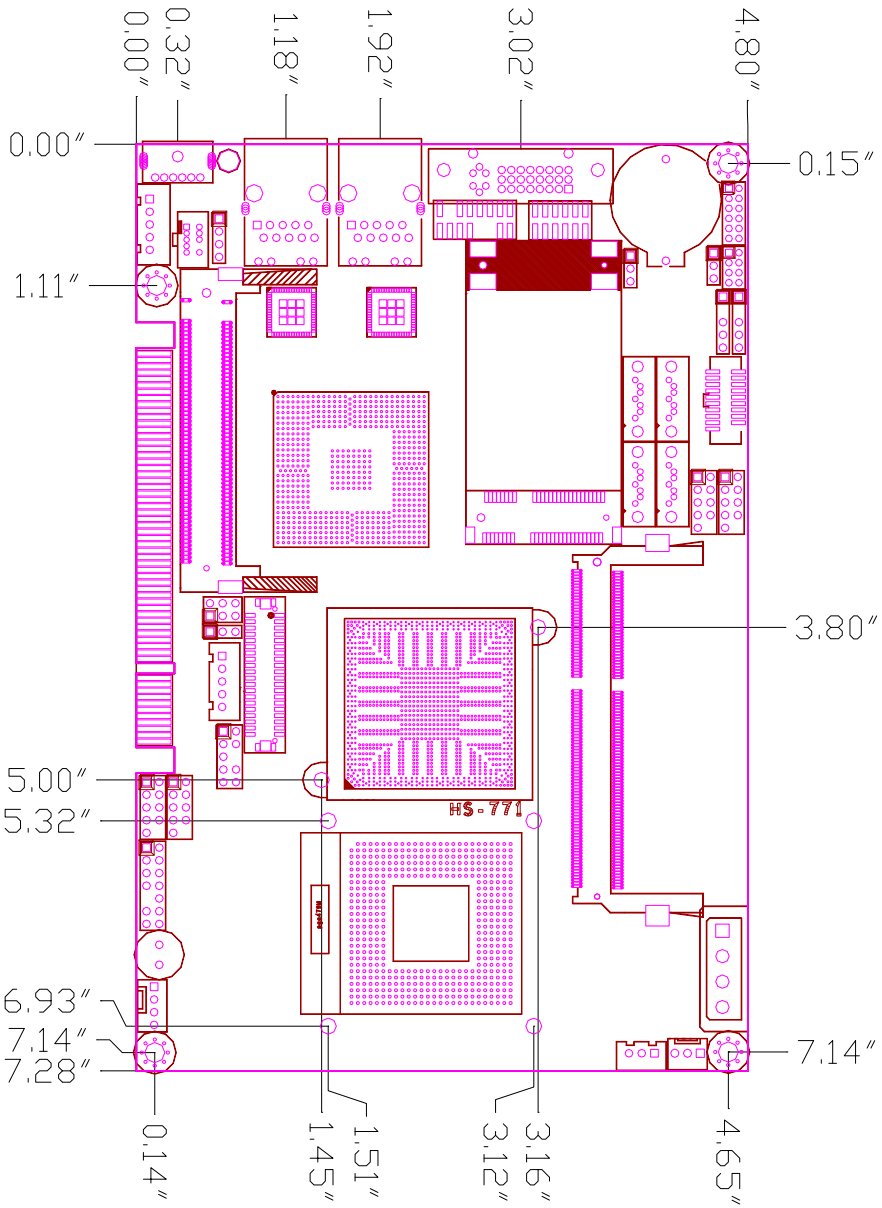

1.4 <Block Diagram>

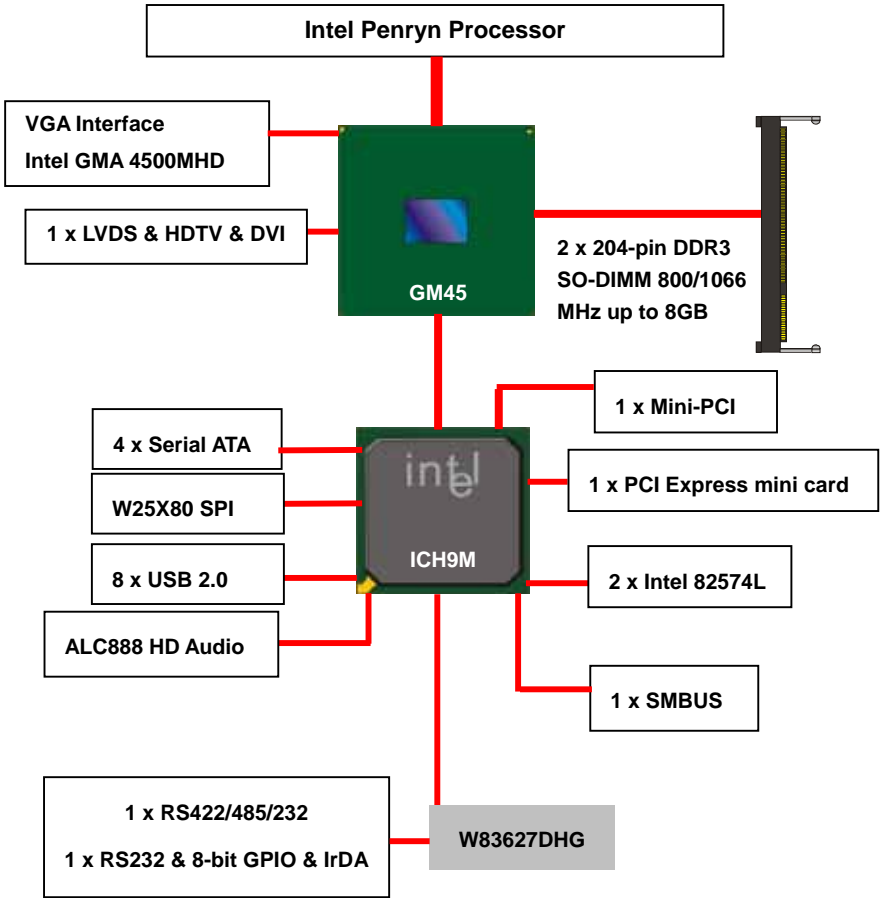

Chapter 2 <Hardware Setup>

2.1 <Connector Location>

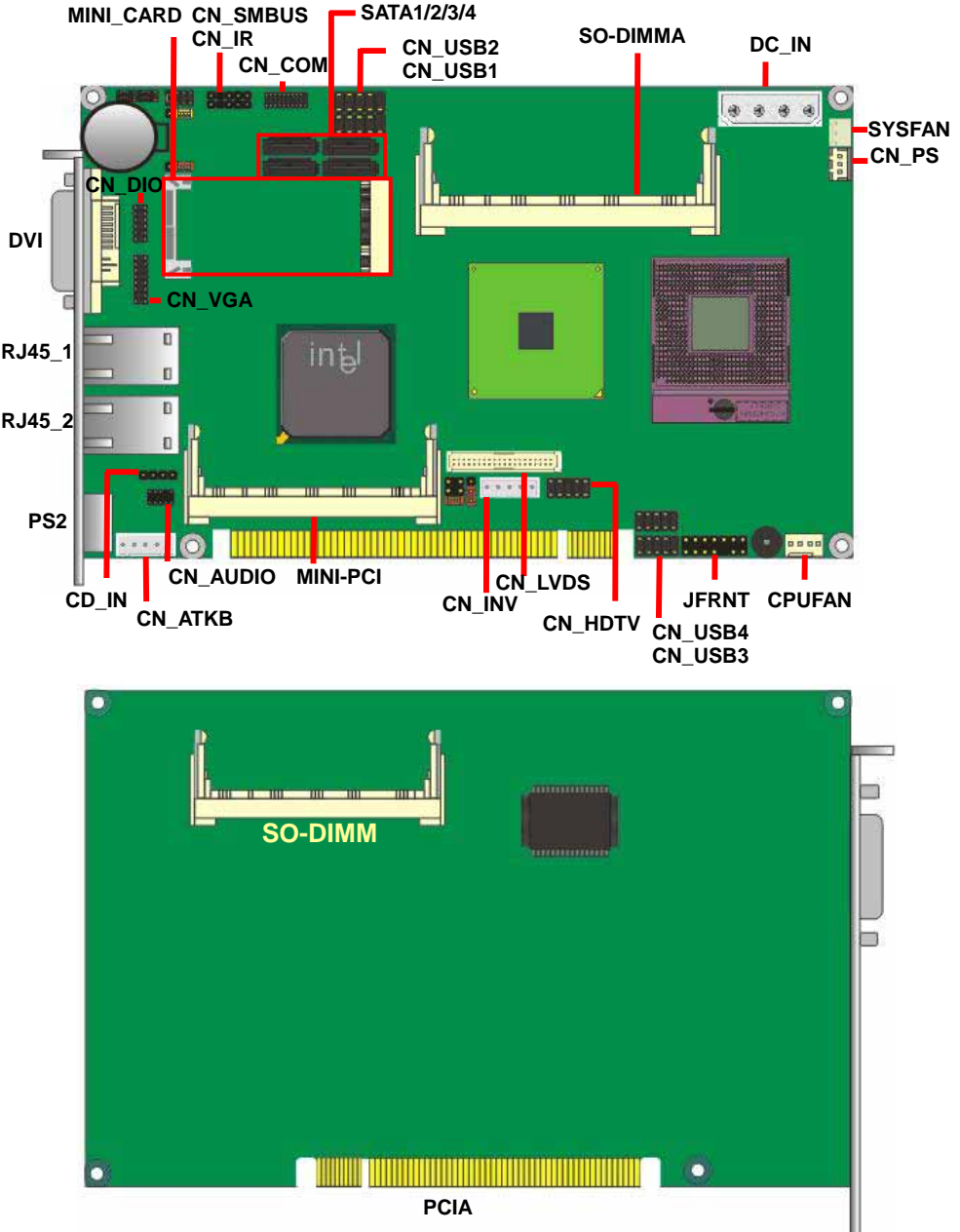

2.2 <Jumper Location & Reference>

Jumper	Function
JRTC	CMOS Operating/Clear Setting
JAT	AT/ATX Mode Setting
JVLCD	Panel Voltage Setting
JVINV	Inverter Voltage Setting
JCSEL1	Com2 RS-232/RS-422/RS-485/IR Setting
JCSEL2	Com2 RS-232/RS-422/RS-485/IR Setting

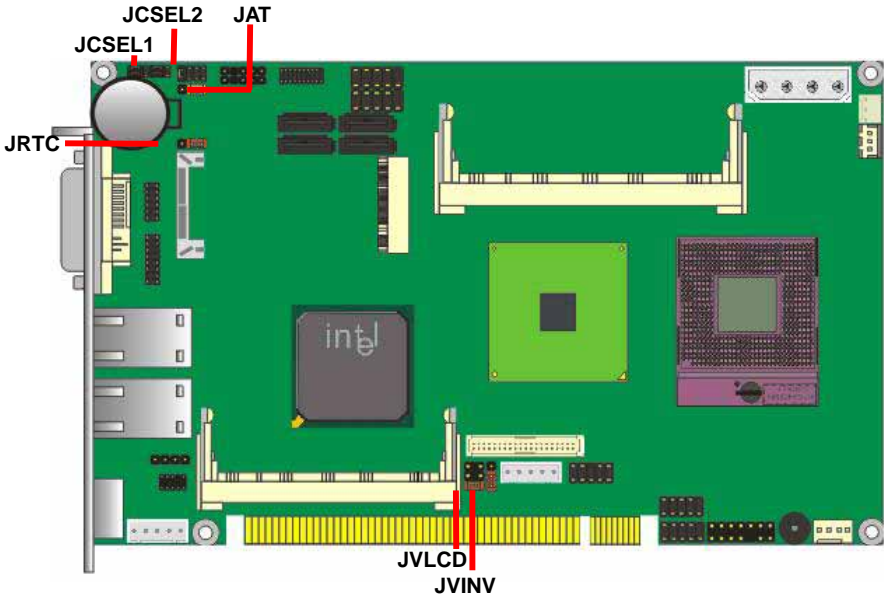

2.2.1 <CMOS Setup>

The board's data of CMOS can be setting in BIOS. If the board refuses to boot due to inappropriate CMOS settings, here is how to proceed to clear (reset) the CMOS to its default values.

Jumper: JRTC



Type: Onboard 3-pin jumper

JRTC	Mode
1-2	Clear CMOS
2-3	Normal Operation

Default setting: 2-3

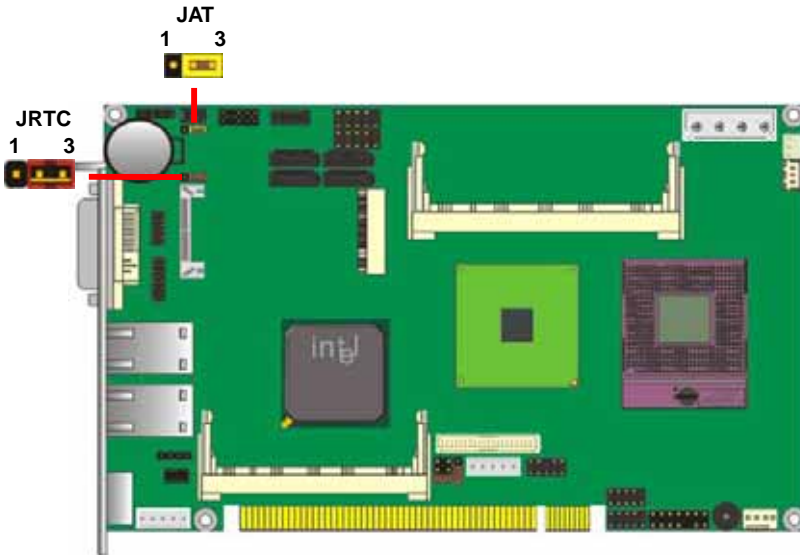

2.2.2 <JAT Setup>

Jumper: JAT



Type: Onboard 3-pin jumper

JRTC	Mode
1-2	AT Mode
2-3	ATX Mode

Default setting: 2-3

2.3 <Connector Reference>

2.3.1 <Internal Connectors>

Connector	Function	Remark
CPU	Socket478 for socket-P CPU	
SO-DIMMA/B	204 -pin DDR3 SO-DIMM socket	
SATA1/2/3/4	7-pin Serial ATA connector	
DC_IN	4-pin power supply connector	
CN_AUDIO	5 x 2-pin audio connector	
CD_IN	4-pin CD-ROM audio input connector	
CN_DIO	6 x 2-pin digital I/O connector	
CN_USB1/2/3/4	5 x 2-pin USB connector	
CPUFAN	4-pin CPU cooler fan connector	
SYSFAN	3-pin system cooler fan connector	
CN_HDTV	5 x 2-pin HDTV interface	
CN_LVDS	20 x 2-pin LVDS connector	
CN_INV	5-pin LCD inverter connector	
CN_IR	5-pin IrDA connector	
CN_SMBUS	5-pin SMBUS connector	
CN_PS	3-pin ATX function connector	
CN_INV	5-pin LCD inverter connector	
CN_ATKB	5-pin AT keyboard connector	
JFRNT	14-pin front panel switch/indicator connector	
Mini-PCI	124-pin Mini-PCI socket Type IIIA	
PCIE Mini card	52-pin PCIE Mini card	
CN_COM	20-pin RS232 & RS422/485/232 connector	

2.3.2 <External Connectors>

Connector	Function	Remark
DVI	DVI Digital VGA connector	
RJ45_1/2	RJ45 LAN connector	
PS/2	PS/2 keyboard and mouse connector	

2.4 <CPU and Memory Setup>

2.4.1 <CPU Setup>

The board comes with the socket478 for Intel Penryn **socket-P** Processor 667/800/1066 MHz of front side bus and 6MB L2 cache. Please follow the instruction to install the CPU properly.

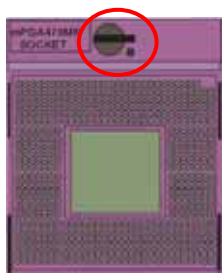

1. Use the flat-type screw drive to unlock the CPU socket



Unlock way

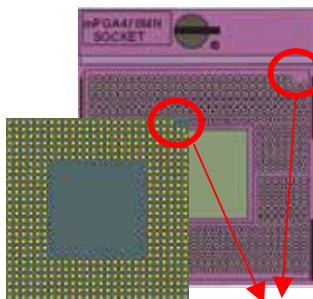

2. Follow the pin direction to install the processor on the socket

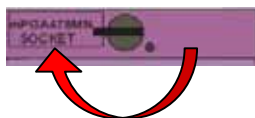

3. Lock the socket

4. Socket P has 478 pins, but is not pin-compatible with Socket M CPU.

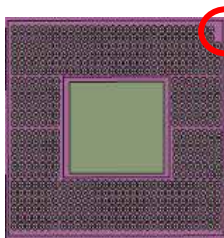

Socket-M CPU
Check point

2.4.2 <Memory Setup>

HS-771 has two 204-pin DDR3 SO-DIMM supports up to 8GB of memory capacity. The memory frequency supports 800/1066MHz. Only Non-ECC memory is supported. Dual-Channel technology is supported while applying two same modules on one of each group.

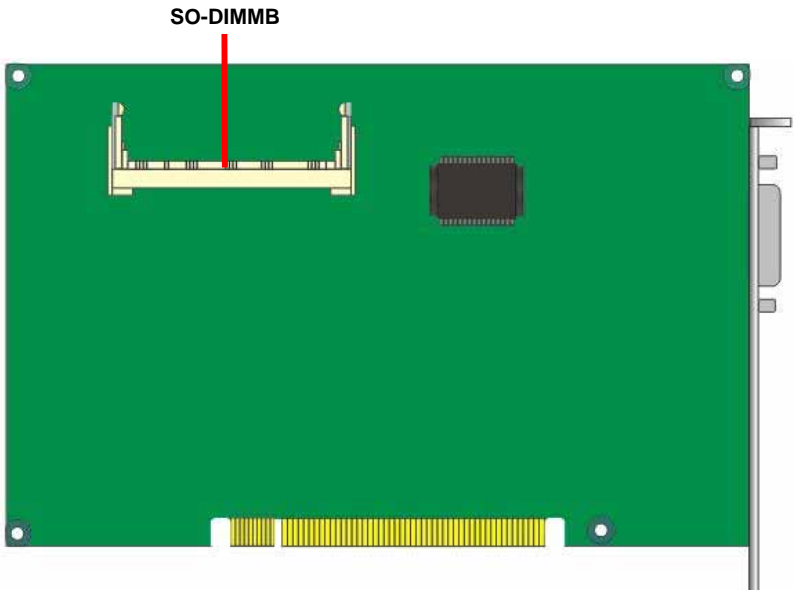
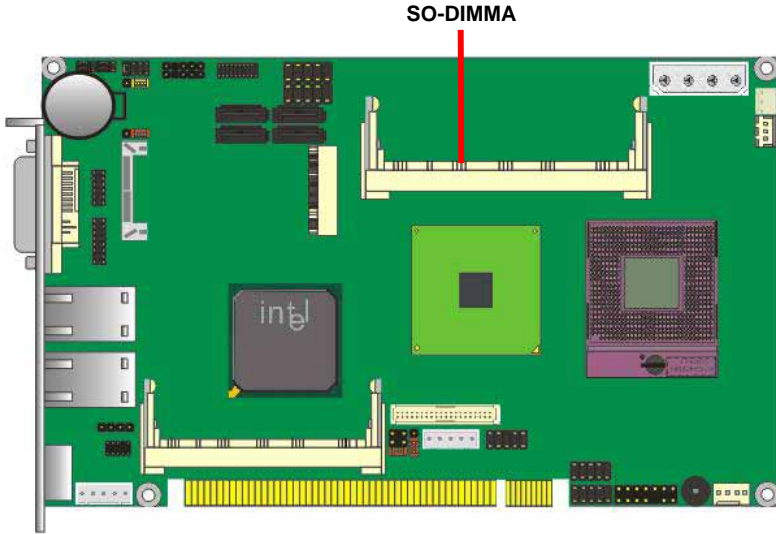

2.5 <Serial ATA Interface>

Based on Intel ICH9M, the board provides four Serial ATAII interfaces with up to 300MB/s of transfer rate.

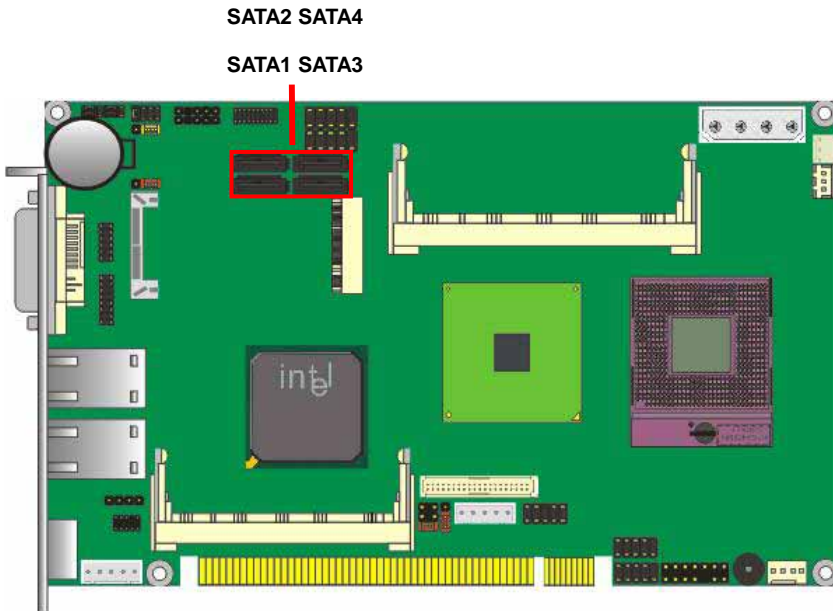

Connector: **SATA1/2/3/4**

Type: 7-pin wafer connector



1	2	3	4	5	6	7
GND	SATA_TXP0	SATA_TXN0	GND	SATA_RXN0	SATA_RXP0	GND

2.6 <Ethernet Interface>

The board integrates with two Intel PCI Express Gigabit Ethernet controllers, as the PCI Express x1 can speed up to 250MB/s of transfer rate instead of late PCI bus with 133MB/s of transfer rate. The Intel Gigabit Ethernet supports triple speed of 10/100/1000Base-T, with IEEE802.3 compliance and Wake-On-LAN supported.

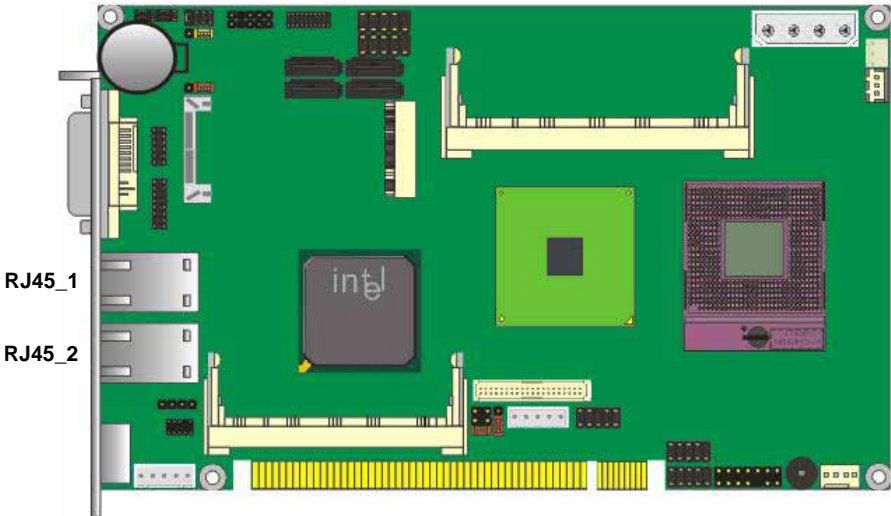

2.6.1 <LAN Port>

Connector: **RJ45_1/2**
 Type: RJ45 connector with LED

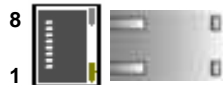

Pin	1	2	3	4	5	6	7	8
Description	MI0+	MI0-	MI1+	MI2+	MI2-	MI1-	MI3+	MI3-

2.7 <Onboard Display Interface>

Based on Intel GM45 chipset with built-in GMA (Graphic Media Accelerator) 4500MHD graphics up to 1024MB shared with system memory, the board provides one DB15 on DVI-I real external DVI VGA cable, one 40-pin LVDS interface with 5-pin LCD backlight inverter connector and one DVI-I on bracket. The board provides dual display function with clone mode and extended desktop mode for VGA, LVDS and HDTV.

2.7.1 <Analog Display>

Please connect your CRT or LCD monitor with DB15 to the DVI VGA cable DB15 female connector on rear I/O port.

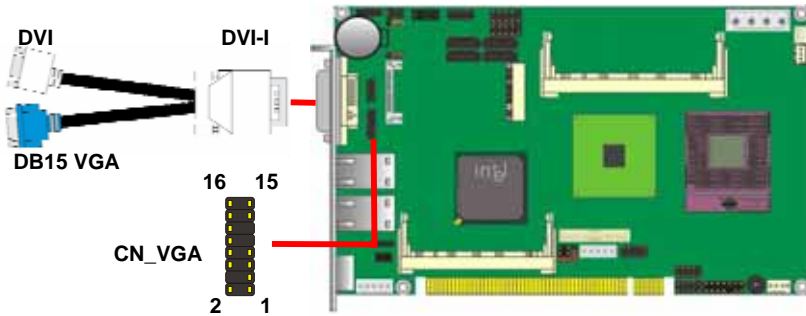

Connector: **CN_VGA**

Type: onboard 16-pin connector for CN_VGA connector pitch 2.00mm

Pin	Signal	Pin	Signal
1	BR	2	BG
3	BB	4	NC
5	-CRTATCH	6	VGAGND
7	-CRTATCH	8	VGAGND
9	NC	10	VGAGND
11	NC	12	5VCDA
13	5HSYNC	14	5VSYNC
15	5VCLK	16	NC

2.7.2 <Digital Display>

The board provides DVI external connector and one 40-pin LVDS connector for 18/24-bit dual channel panels, supports up to 1920 x 1200 (UXGA) resolution, with one LCD backlight inverter connector and one jumper for panel voltage setting.

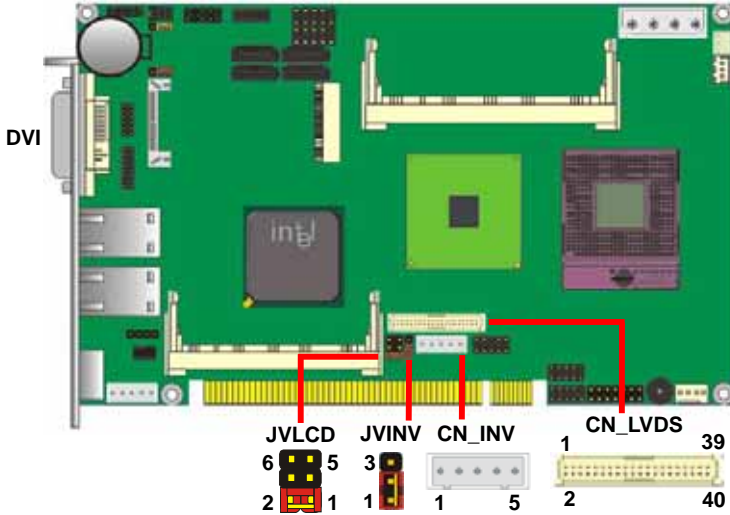

Effective patterns of connection: 1-2 / 3-4 / 5-6



Warning: others cause damages

HS-771 User's Manual

Connector: **CN_INV**

Type: 5-pin LVDS Power Header

Pin	Description
1	+12V
2	Reserved (Note)
3	GND
4	GND
5	ENABKL

Note: Reserved for MB internal test
Please treat it as NC.

Connector: **JVINV**

Type: 3-pin LVDS Power Header

Pin	Description
1-2	INV_VCC (+12V)
3-4	INV_VCC (5V)

Default: 1-2

Connector: **JVLCD**

Type: 6-pin Power select Header

Pin	Description
1-2	LCDVCC (3.3V)
3-4	LCDVCC (5V)
5-6	LCDVCC (12V)

Default: 1-2

Connector: **CN_LVDS**

Type: onboard 40-pin connector for LVDS connector

Connector model: **HIROSE DF13-40DP-1.25V**

Pin	Description	Pin	Description
2	LCDVCC	1	LCDVCC
4	GND	3	GND
6	ATX0-	5	BTX0-
8	ATX0+	7	BTX0+
10	GND	9	GND
12	ATX1-	11	BTX1-
14	ATX1+	13	BTX1+
16	GND	15	GND
18	ATX2-	17	BTX2-
20	ATX2+	19	BTX2+
22	GND	21	GND
24	ACLK-	23	BTX3-
26	ACLK+	25	BTX3+
28	GND	27	GND
30	ATX3-	29	BCLK-
32	ATX3+	31	BCLK+
34	GND	33	GND
36	DDCPCLK	35	N/C
38	DDCPDATA	37	N/C
40	N/C	39	N/C

HS-771 User's Manual

To setup the LCD, you need the component below:

1. A panel with LVDS interfaces.
2. An inverter for panel's backlight power.
3. A LCD cable and an inverter cable.

For the cables, please follow the pin assignment of the connector to make a cable, because every panel has its own pin assignment, so we do not provide a standard cable; please find a local cable manufacture to make cables.

LCD Installation Guide:

1. Preparing the **HS-771**, **LCD panel** and the **backlight inverter**.

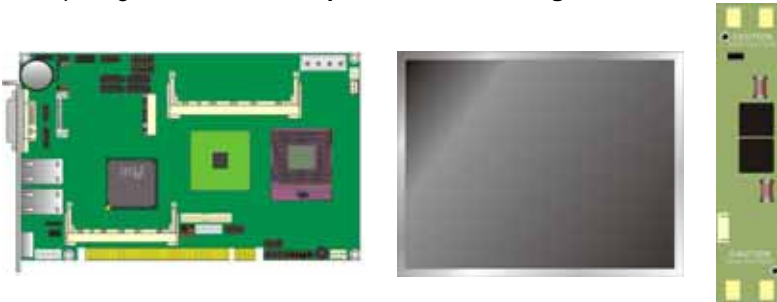

2. Please check the datasheet of the panel to see the voltage of the panel, and set the jumper **JVLCD** to +12V or +5V or +3.3V.
3. You would need a LVDS type cable.

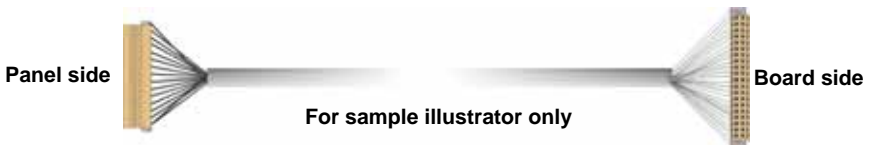

4. To connect all of the devices well.

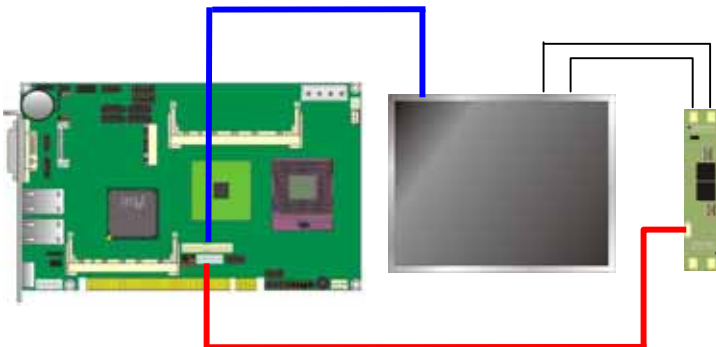

After setup the devices well, you need to select the LCD panel type in the BIOS.

The panel type mapping is list below:

BIOS panel type selection form (BIOS Version:1.0)			
18-bit Single channel		24-bit Dual channel	
NO.	Output format	NO.	Output format
1	640 x 480	1	1280 x 768
2	800 x 480	2	1280 x 1024
3	800 x 600	3	1600 x 1200
4	1024 x 768	4	1920 x 1080
5	1280 x 800	5	1920 x 1200
18-bit Dual channel			
1	1280 x 768		
24-bit Single channel			
1	1024 x 768		
2	1280 x 768		
3	1280 x 800		
4	1366 x 768		

2.7.2 <HDTV Interface>

The board provides an HDTV interface with Intel GM45, support PAL and NTSC of TV system, and display (clone or extended desktop) function with VGA, DVI and LVDS.

Connector: **CN_HDTV**

Connector type: 10-pin header HDTV connector pitch 2.54mm (**Optional cable**)

Pin Number	Description	Pin Number	Description
1	GND	2	DACB_L
3	DACC_L	4	GND
5	GND	6	N/C
7	DACA_L	8	GND
9	N/C	10	N/C

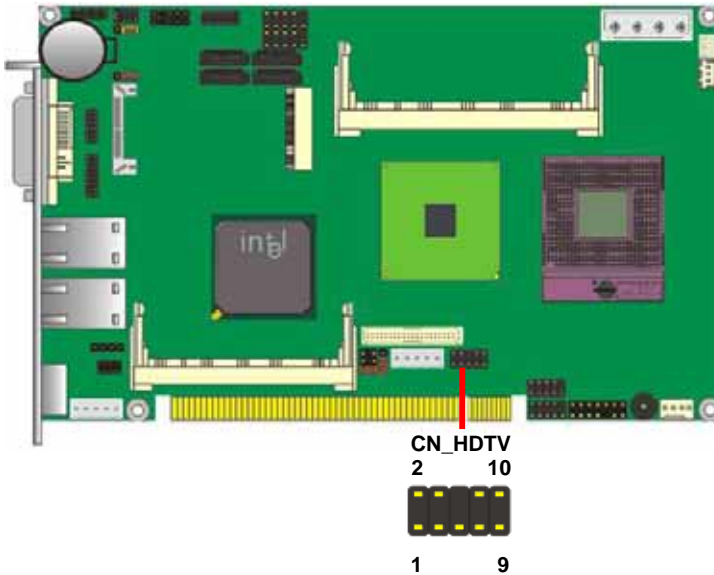

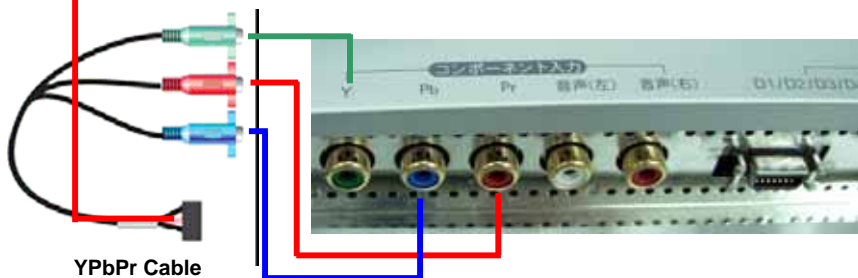
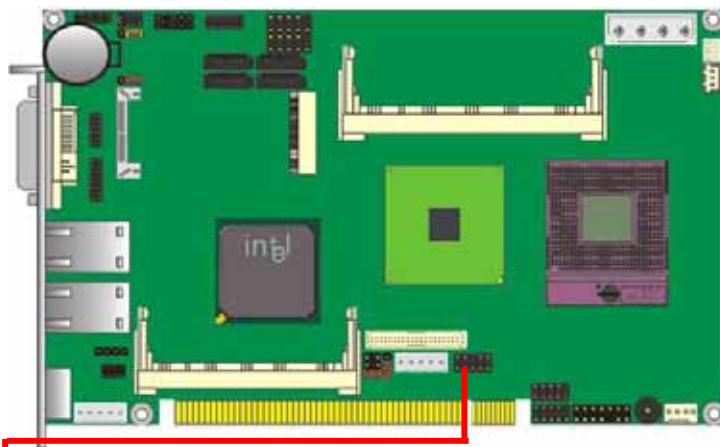

YPbPr Cable
(Optional cable)

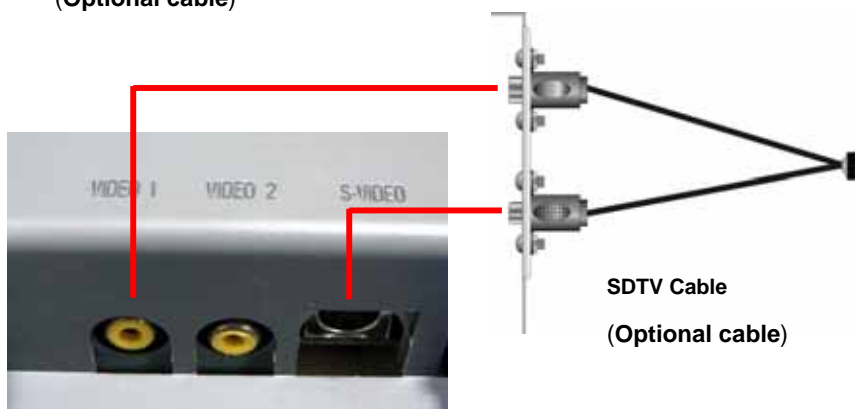

SDTV Cable
(Optional cable)

2.8 <Integrated Audio Interface>

The board integrates onboard audio interface with REALTEK ALC888 codec, with Intel next generation of audio standard as High Definition Audio, it offers more sound and other advantages than former HD audio compliance.

The main specifications of ALC888 are:

- **High-performance DACs with 100dB S/N ratio**
- **2 DAC channels support 16/20/24-bit PCM format for 2 audio solution**
- **16Compatible with HD**
- **Meets Microsoft WHQL/WLP 2.0 audio requirements**

The board provides 2 channels audio phone jacks and MIC-in port for front I/O panel through audio cable.

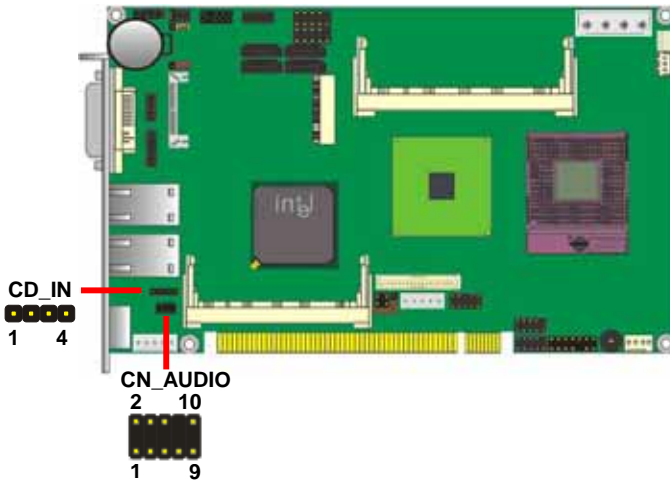

Connector: CN_AUDIO

Type: 10-pin (2 x 5) header
(pitch = 2.54mm x 1.27mm)

Pin	Description	Pin	Description
1	MIC_L	2	Ground
3	MIC_R	4	Reserve
5	Speaker_R	6	MIC Detect
7	SENSE	8	N/C
9	Speaker_L	10	Speaker Detect

Connector: CD_IN

Type: 4-pin header
(pitch = 2.54mm)

Pin	Description
1	MIC_L
3	MIC_R
5	Speaker_R
7	SENSE
9	Speaker_L

2.9 <GPIO Interface>

The board provides a programmable 8-bit digital I/O interface; you can use this general purpose I/O port for system control like POS or KIOSK.

Connector: **CN_DIO**

Type: 12-pin (6 x 2) header (pitch = 2.0mm)

Pin	Description	Pin	Description
1	Ground	2	Ground
3	GP10	4	GP14
5	GP11	6	GP15
7	GP12	8	GP16
9	GP13	10	GP17
11	VCC	12	+12V

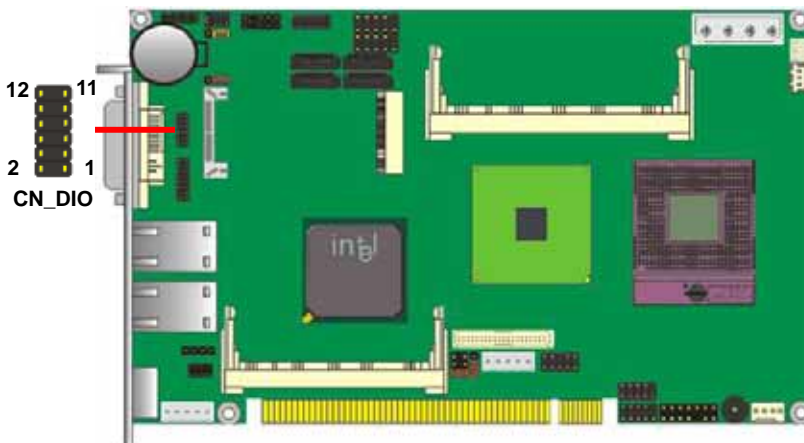

2.10 <Power Supply>

2.10.1 <Power Input>

The board requires onboard 4-pin DC 5V/12V power required, optional 5VSB for ATX.

Connector: **DC_IN**

Type: 4-pin DC power connector

Pin	Description
1	+12V
2	Ground
3	Ground
4	+5V

Connector: **CN_PS**

Type: 3-pin ATX function connector

Pin	Description
1	5VSTBY
2	Ground
3	-PSON

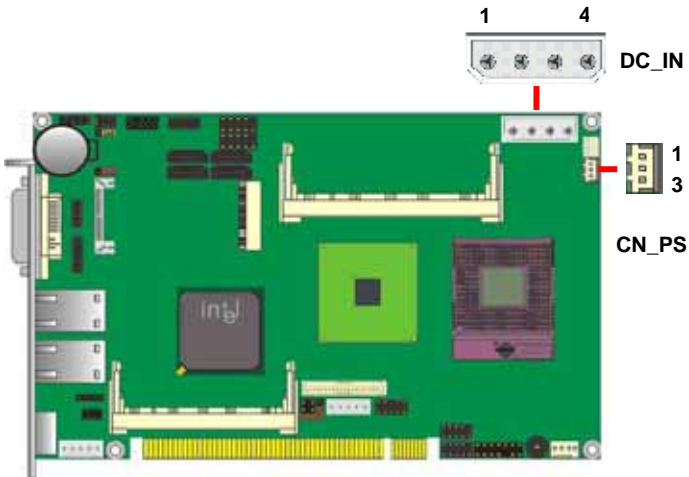

2.11 <Switch and Indicator>

The **JFRNT** provides front control panel of the board, such as power button, reset and beeper, etc. Please check well before you connecting the cables on the chassis.

Connector: **JFRNT**

Type: onboard 14-pin (2 x 7) header pitch = 2.54mm

Function	Signal	PIN		Signal	Function
IDE LED	HDLED+	1	2	PWRLED+	Power LED
	HDLED-	3	4	N/C	
Reset	Reset+	5	6	PWRLED-	Speaker
	Reset-	7	8	SPK+	
N/C		9	10	N/C	
Power	PWRBT-	11	12	N/C	
Button	PWRBT+	13	14	SPK-	

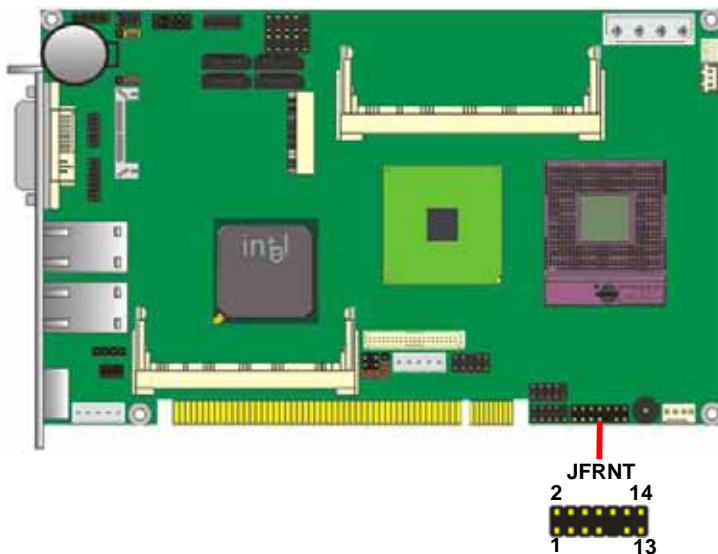

2.12 <Serial Port>

The board supports one RS232 serial port and one jumper selectable RS232/ 422/485 serial ports. The jumper JCSEL1 and JCSEL2 can let you configure the communicating modes for COM2.

Connector: **CN_COM**

Type: 20-pin (2 x 10) header pitch = 2.54x1.27mm

Pin	Description	Pin	Description
1	DCD1	2	RXD1
3	TXD1	4	DTR1
5	Ground	6	DSR1
7	RTS1	8	CTS1
9	RI1	10	N/C
11	DCD2/422TX-/485-	12	RX2/422TX+/485+
13	TX2/422RX+	14	DTR2/422RX-
15	Ground	16	DSR2
17	RTS2	18	CTS2
19	RI2	20	N/C

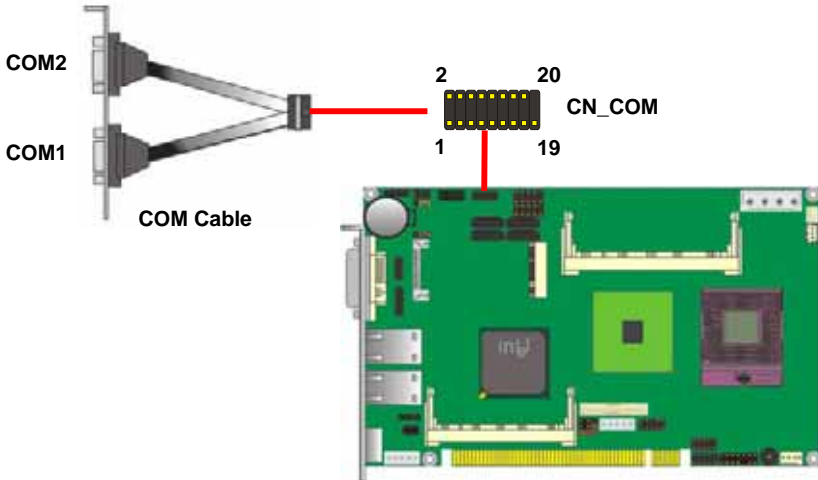

Setting RS-232/RS-422/RS-485/IrDA:

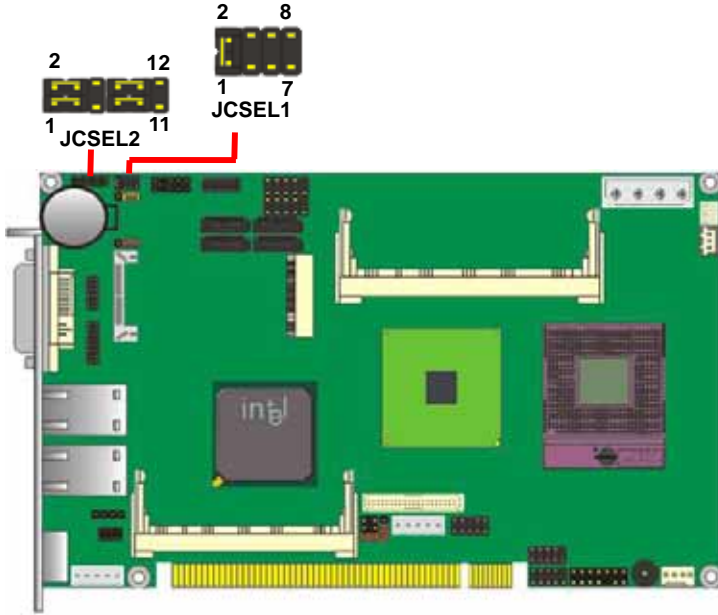

Function	JCSSEL1	JCSSEL2
IrDA		
RS-422		
RS-485		
RS-232		

Default: RS-232

2.13 <USB Ports>

Based on ICH9M, the board provides eight USB2.0 ports with provides up to 480Mbps of transferring rate.

Interface	USB2.0
Controller	ICH9M
Transfer Rate	Up to 480Mb/s
Output Current	500mA

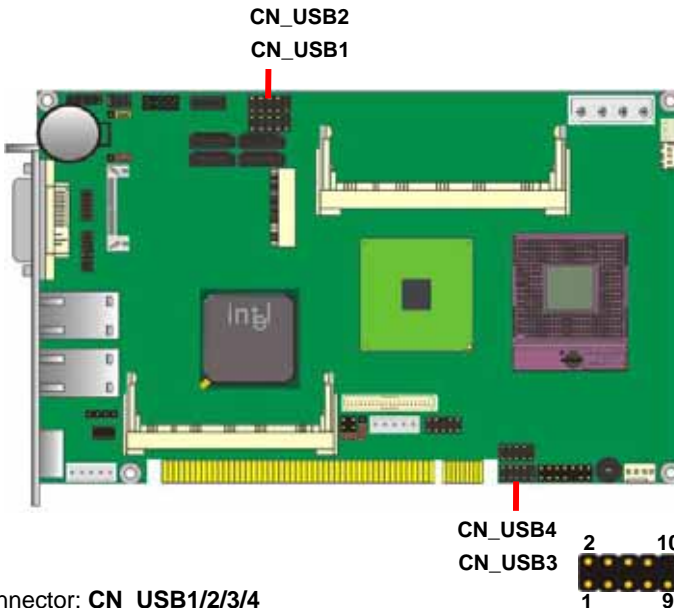

Connector: **CN_USB1/2/3/4**

Type: 10-pin 5 x 2 header for dual USB Ports pitch = 2.54mm

Pin	Description	Pin	Description
1	VCC	2	VCC
3	Data0-	4	Data1-
5	Data0+	6	Data1+
7	Ground	8	Ground
9	Ground	10	N/C

PS: The USB2.0 will be only active when you connecting with the USB2.0 devices, if you insert an USB1.1 device, the port will be changed to USB1.1 protocol automatically. The transferring rate of USB2.0 as 480Mbps is depending on device capacity, exact transferring rate may not be up to 480Mbps.

2.14 <Keyboard & Mouse Port>

2.14.1 <PS2 Port>

The PS/2 connector supports standard PS/2 keyboard directly or both PS/2 keyboard and mouse through for PS/2 Y-cable.

Connector: **PS2**

Type: 6-pin Mini-DIN connector on bracket

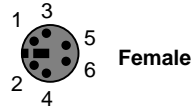

Pin	1	2	3	4	5	6
Description	KBCLK	MSCLK	Ground	VCC	KBDATA	MSDATA

2.14.2 <ATKB Port>

Connector: **CN_ATKB**

Type: 5-pin box header



Pin	1	2	3	4	5
Description	VCC	Ground	N/C	KBDATA	KBCLK

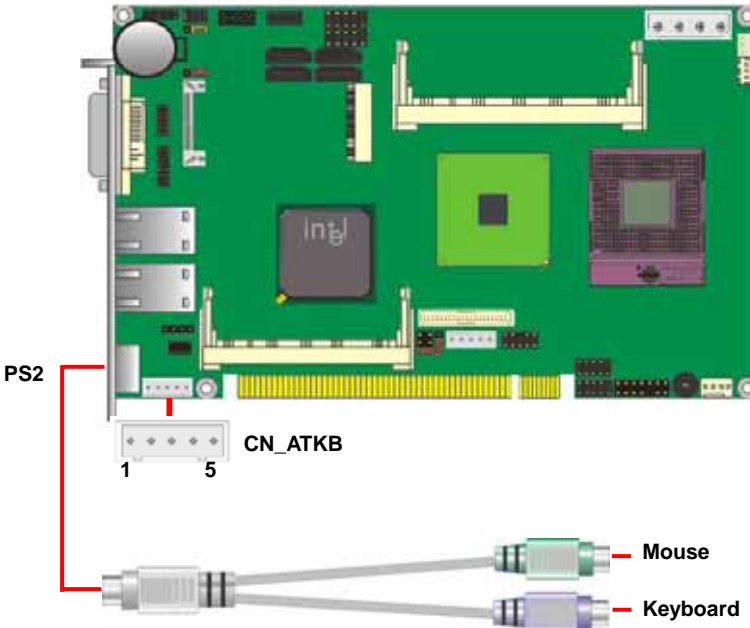

2.15 <PCI Express Mini Card>

The PCI Express Mini Cards are 30 x 56 mm. There is a 52 pin edge connector.

Connector: **MINI_CARD**

Type: 52-pin edge connector

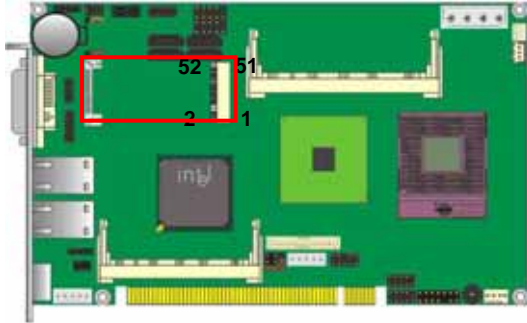

2.16 <Mini PCI Interface>

The system connector for Type III consists of a 124-pin card edge type connector.

Connector: **MINI-PCI**

Type: 124-pin Type III edge connector

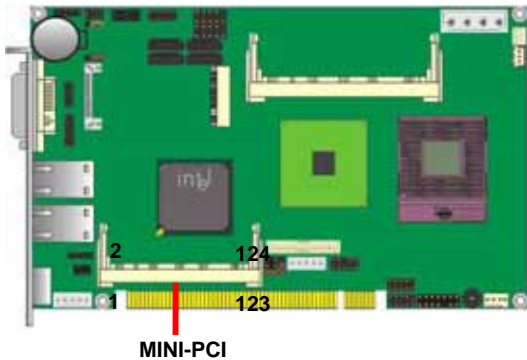

Chapter 3 <System Setup>

3.1 <Audio Configuration>

The board integrates Intel® ICH9M with REALTEK® ALC888 codec. It can support 2-channel sound under system configuration. Please follow the steps below to setup your sound system.

1. Install REALTEK HD Audio driver.
2. Launch the control panel and Sound Effect Manager.

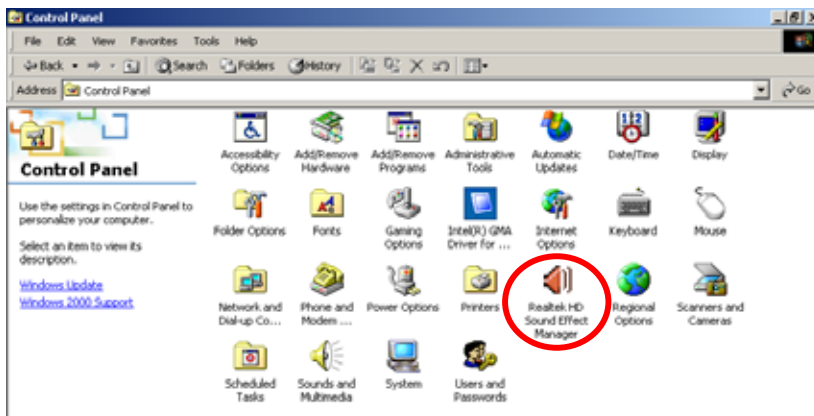

3. Select Speaker Configuration



3.2 <Display Properties Setting>

Based on Intel GM45 GMCH with GMA 4500MHD (Graphic Media Accelerator) up to 1024MB shared with system memory, the board supports two DACs for display device as different resolution and color bit.

Please install the Intel Graphic Driver before you starting setup display devices.

1. Click right button on the desktop to lunch **display properties**
2. Click **Advanced** button for more specificity setup.

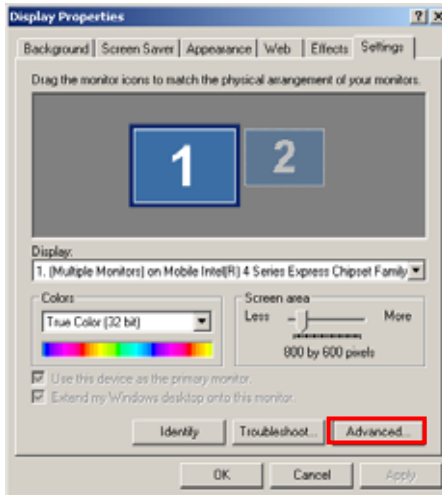

Click **Graphics Properties...** for advanced setup

3. This setup options can let you define each device settings.

Select **Intel(R) Dual Display Clone** for Colors, Resolution and Refresh Rate

Select **Dual Display Clone** to setup the dual display mode as same screen

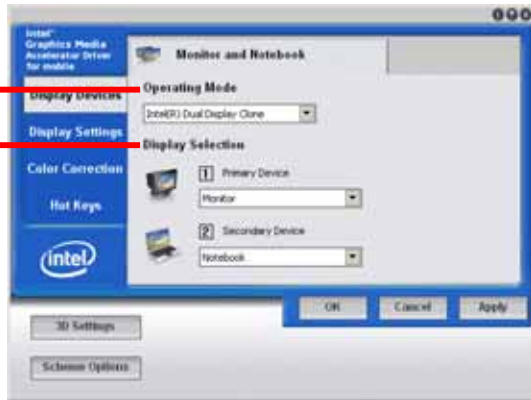

Select **Extended Desktop** for Colors, Resolution and Refresh Rate

Select **Extended Desktop** to setup the dual display mode as same screen

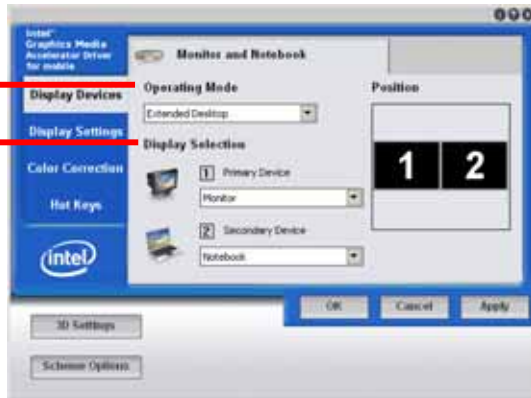

Chapter 4 <BIOS Setup>

The motherboard uses the Award BIOS for the system configuration. The Award BIOS in the single board computer is a customized version of the industrial standard BIOS for IBM PC AT-compatible computers. It supports Intel x86 and compatible CPU architecture based processors and computers. The BIOS provides critical low-level support for the system central processing, memory and I/O sub-systems.

The BIOS setup program of the single board computer let the customers modify the basic configuration setting. The settings are stored in a dedicated battery-backed memory, NVRAM, retains the information when the power is turned off. If the battery runs out of the power, then the settings of BIOS will come back to the default setting.

The BIOS section of the manual is subject to change without notice and is provided here for reference purpose only. The settings and configurations of the BIOS are current at the time of print, and therefore they may not be exactly the same as that displayed on your screen.

To activate CMOS Setup program, press key immediately after you turn on the system. The following message "Press DEL to enter SETUP" should appear in the lower left hand corner of your screen. When you enter the CMOS Setup Utility, the Main Menu will be displayed as **Figure 4-1**. You can use arrow keys to select your function, press <Enter> key to accept the selection and enter the sub-menu.

Figure 4-1 CMOS Setup Utility Main Screen

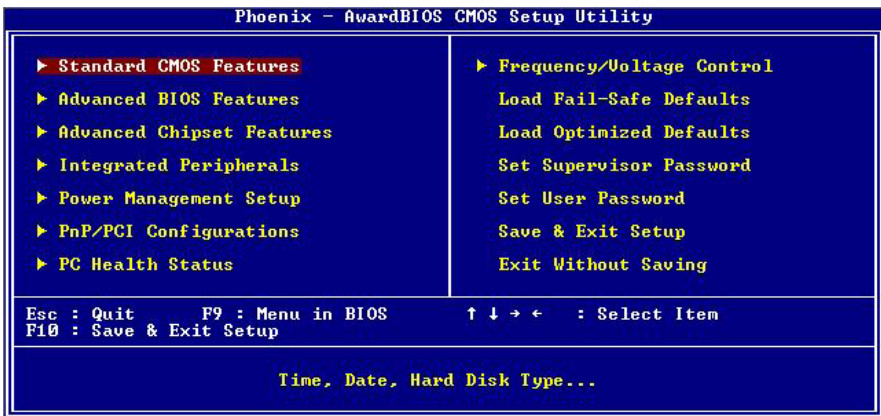

(This page is left for blank)

Appendix A <I/O Port Pin Assignment>

A.1 <SMBUS Port>

Connector: **CN_SMBUS**

Type: 5-pin header for SMBUS Port

Pin	Description
1	VCC
2	N/C
3	SMBDATA
4	SMBCLK
5	Ground



A.2 <IrDA Port>

Connector: **CN_IR**

Type: 5-pin header for SIR Ports

Pin	Description
1	VCC
2	N/C
3	IRRX
4	Ground
5	IRTX



JCSEL1 must jump to "SIR"

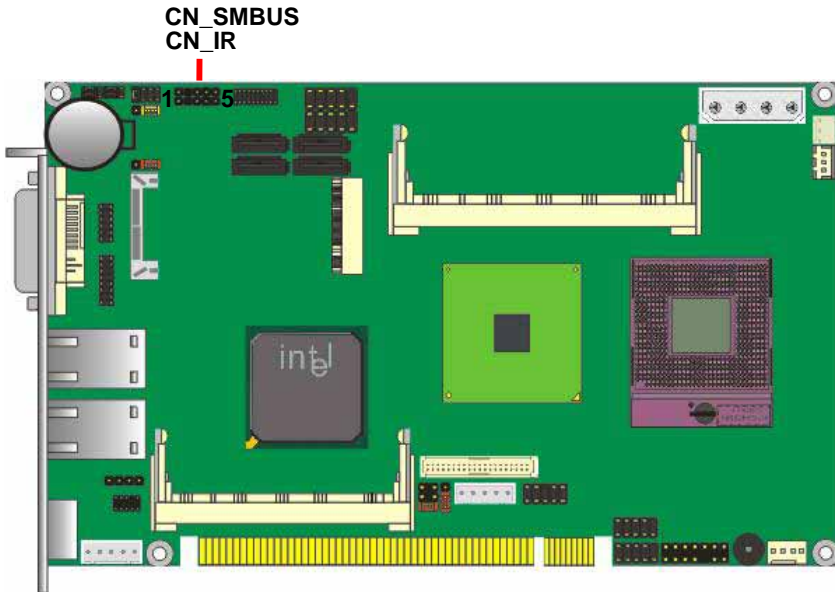

Appendix B <Flash BIOS>

B.1 <Flash Tool>

The board is based on Award BIOS and can be updated easily by the BIOS auto flash tool. You can download the tool online at the address below:

<http://www.phoenix.com/en/home/>

http://www.commell.com.tw/Support/Support_SBC.htm

File name of the tool is "awdf flash.exe", it's the utility that can write the data into the BIOS flash chip and update the BIOS.

B.2 <Flash BIOS Procedure>

1. Please make a bootable floppy disk.
2. Get the last .bin files you want to update and copy it into the disk.
3. Copy XXX.bin and awdf flash.exe to the disk.
4. Power on the system and flash the BIOS. (Example: C:/ awdf flash XXX.bin)
5. Restart the system.

Any question about the BIOS re-flash please contact your distributors or visit the web-site at below:

<http://www.commell.com.tw/support/support.htm>





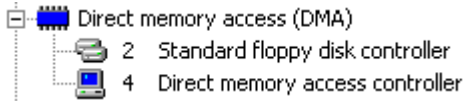



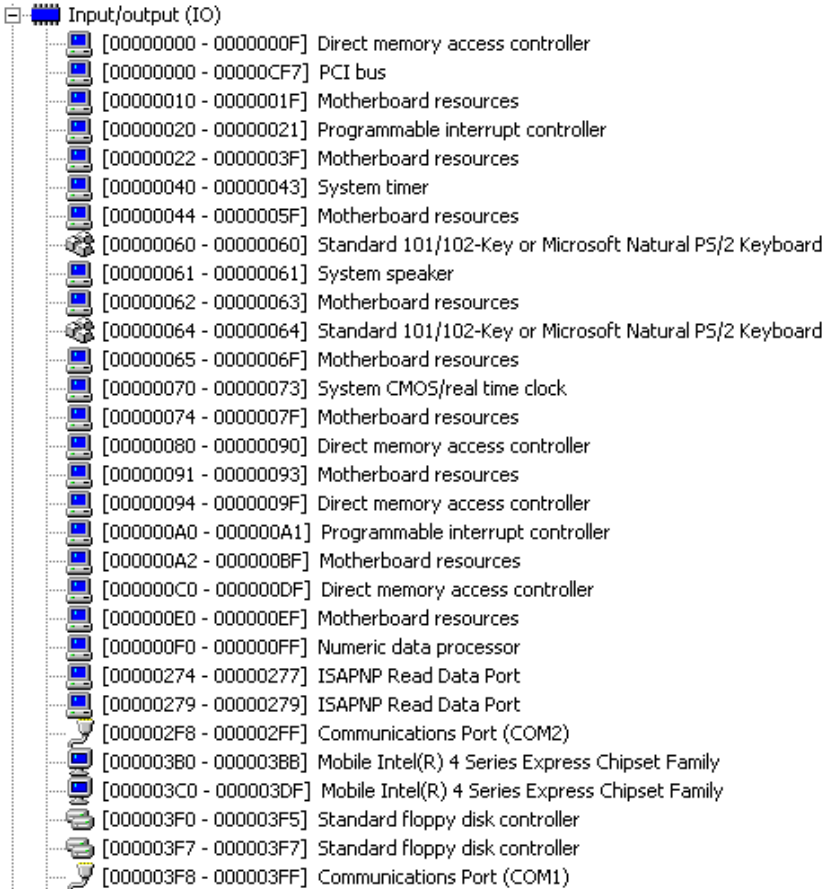





















Appendix C <System Resources>

C.1 <Direct memory access (DMA)>



C.2 <Input/Output (IO)>







































	[00000400 - 000004BF] Motherboard resources
	[000004D0 - 000004D1] Motherboard resources
	[00000500 - 0000051F] Intel(R) ICH9 Family SMBus Controller - 2930
	[00000680 - 000006FF] Motherboard resources
	[00000880 - 0000088F] Motherboard resources
	[00000A79 - 00000A79] ISAPNP Read Data Port
	[00000D00 - 0000FFFF] PCI bus
	[00007000 - 00007FFF] Intel(R) ICH9 Family PCI Express Root Port 1 - 2940
	[00009000 - 00009FFF] Intel(R) ICH9 Family PCI Express Root Port 3 - 2944
	[00009C00 - 00009C1F] Intel(R) 82574L Gigabit Network Connection #2
	[0000A000 - 0000AFFF] Intel(R) ICH9 Family PCI Express Root Port 2 - 2942
	[0000AC00 - 0000AC1F] Intel(R) 82574L Gigabit Network Connection
	[0000B000 - 0000B00F] Intel(R) ICH9M/M-E 2 port Serial ATA Storage Controller 2 - 292D
	[0000B400 - 0000B40F] Intel(R) ICH9M/M-E 2 port Serial ATA Storage Controller 2 - 292D
	[0000B800 - 0000B803] Intel(R) ICH9M/M-E 2 port Serial ATA Storage Controller 2 - 292D
	[0000BC00 - 0000BC07] Intel(R) ICH9M/M-E 2 port Serial ATA Storage Controller 2 - 292D
	[0000C000 - 0000C003] Intel(R) ICH9M/M-E 2 port Serial ATA Storage Controller 2 - 292D
	[0000C400 - 0000C407] Intel(R) ICH9M/M-E 2 port Serial ATA Storage Controller 2 - 292D
	[0000CC00 - 0000CC0F] Intel(R) ICH9M/M-E 2 port Serial ATA Storage Controller 1 - 2928
	[0000D000 - 0000D00F] Intel(R) ICH9M/M-E 2 port Serial ATA Storage Controller 1 - 2928
	[0000D400 - 0000D403] Intel(R) ICH9M/M-E 2 port Serial ATA Storage Controller 1 - 2928
	[0000D800 - 0000D807] Intel(R) ICH9M/M-E 2 port Serial ATA Storage Controller 1 - 2928
	[0000DC00 - 0000DC03] Intel(R) ICH9M/M-E 2 port Serial ATA Storage Controller 1 - 2928
	[0000E000 - 0000E007] Intel(R) ICH9M/M-E 2 port Serial ATA Storage Controller 1 - 2928
	[0000E400 - 0000E41F] Intel(R) ICH9 Family USB Universal Host Controller - 2936
	[0000E800 - 0000E81F] Intel(R) ICH9 Family USB Universal Host Controller - 2935
	[0000EC00 - 0000EC1F] Intel(R) ICH9 Family USB Universal Host Controller - 2934
	[0000F000 - 0000F01F] Intel(R) ICH9 Family USB Universal Host Controller - 2939
	[0000F400 - 0000F41F] Intel(R) ICH9 Family USB Universal Host Controller - 2938
	[0000F800 - 0000F81F] Intel(R) ICH9 Family USB Universal Host Controller - 2937
	[0000FC00 - 0000FC07] Mobile Intel(R) 4 Series Express Chipset Family

C.3 <Interrupt request (IRQ)>

Interrupt request (IRQ)	
(ISA) 0	System timer
(ISA) 1	Standard 101/102-Key or Microsoft Natural PS/2 Keyboard
(ISA) 3	Communications Port (COM2)
(ISA) 6	Standard floppy disk controller
(ISA) 8	System CMOS/real time clock
(ISA) 9	Microsoft ACPI-Compliant System
(ISA) 13	Numeric data processor
(PCI) 11	Intel(R) ICH9 Family SMBus Controller - 2930
(PCI) 16	Intel(R) ICH9 Family PCI Express Root Port 1 - 2940
(PCI) 16	Intel(R) ICH9 Family USB Universal Host Controller - 2937
(PCI) 16	Mobile Intel(R) 4 Series Express Chipset Family
(PCI) 17	Intel(R) 82574L Gigabit Network Connection
(PCI) 17	Intel(R) ICH9 Family PCI Express Root Port 2 - 2942
(PCI) 18	Intel(R) 82574L Gigabit Network Connection #2
(PCI) 18	Intel(R) ICH9 Family PCI Express Root Port 3 - 2944
(PCI) 18	Intel(R) ICH9 Family USB Universal Host Controller - 2936
(PCI) 18	Intel(R) ICH9 Family USB2 Enhanced Host Controller - 293C
(PCI) 19	Intel(R) ICH9 Family USB Universal Host Controller - 2939
(PCI) 19	Intel(R) ICH9 Family USB Universal Host Controller - 2935
(PCI) 19	Intel(R) ICH9M/M-E 2 port Serial ATA Storage Controller 1 - 2928
(PCI) 19	Intel(R) ICH9M/M-E 2 port Serial ATA Storage Controller 2 - 292D
(PCI) 21	Intel(R) ICH9 Family USB Universal Host Controller - 2938
(PCI) 22	Microsoft UAA Bus Driver for High Definition Audio
(PCI) 23	Intel(R) ICH9 Family USB Universal Host Controller - 2934
(PCI) 23	Intel(R) ICH9 Family USB2 Enhanced Host Controller - 293A

C.4 <Memory>

Memory

	[00000000 - 0009FFFF] System board
	[000A0000 - 000BFFFF] Mobile Intel(R) 4 Series Express Chipset Family
	[000A0000 - 000BFFFF] PCI bus
	[000C0000 - 000DFFFF] PCI bus
	[000E0000 - 000EFFFF] System board
	[000F0000 - 000FFFFFF] System board
	[00100000 - 7BC8FFFF] System board
	[7BC90000 - 7BCFFFFFF] System board
	[7BD00000 - 7BDFFFFFF] System board
	[7BD00000 - FEBFFFFFF] PCI bus
	[D0000000 - DFFFFFFF] Mobile Intel(R) 4 Series Express Chipset Family
	[E0000000 - EFFFFFFF] Motherboard resources
	[FD000000 - FD3FFFFFF] Mobile Intel(R) 4 Series Express Chipset Family
	[FD600000 - FD6FFFFFF] Intel(R) ICH9 Family PCI Express Root Port 1 - 2940
	[FDA00000 - FDAFFFFFF] Intel(R) ICH9 Family PCI Express Root Port 3 - 2944
	[FDB00000 - FDBFFFFFF] Intel(R) ICH9 Family PCI Express Root Port 3 - 2944
	[FDBC0000 - FDBDFFFF] Intel(R) 82574L Gigabit Network Connection #2
	[FDBFC000 - FDBFFFFFF] Intel(R) 82574L Gigabit Network Connection #2
	[FDC00000 - FDCFFFFFF] Intel(R) ICH9 Family PCI Express Root Port 2 - 2942
	[FDD00000 - FDDFFFFFF] Intel(R) ICH9 Family PCI Express Root Port 2 - 2942
	[FDDC0000 - FDDDFFFF] Intel(R) 82574L Gigabit Network Connection
	[FDDFC000 - FDDFFFFFF] Intel(R) 82574L Gigabit Network Connection
	[FDE00000 - FDEFFFFFF] Intel(R) ICH9 Family PCI Express Root Port 1 - 2940
	[FDFF4000 - FDFF7FFF] Microsoft UAA Bus Driver for High Definition Audio
	[FDFFD000 - FDFFD0FF] Intel(R) ICH9 Family SMBus Controller - 2930
	[FDFFE000 - FDFFE3FF] Intel(R) ICH9 Family USB2 Enhanced Host Controller - 293A
	[FDFFF000 - FDFFF3FF] Intel(R) ICH9 Family USB2 Enhanced Host Controller - 293C
	[FEB00000 - FEBFFFFFF] Mobile Intel(R) 4 Series Express Chipset Family
	[FEC00000 - FEC00FFF] System board
	[FED00000 - FED000FF] System board
	[FED13000 - FED1FFFF] System board
	[FED20000 - FED9FFFF] System board
	[FEE00000 - FEE00FFF] System board
	[FFB00000 - FFB7FFFF] System board
	[FFB80000 - FFBFFFFFF] Intel(r) 82802 Firmware Hub Device
	[FFF00000 - FFFFFFFF] System board

Appendix D <Programming GPIO's>

The GPIO can be programmed with the MSDOS debug program using simple IN/OUT commands. The following lines show an example how to do this.

GPIO0.....GPIO7 bit0.....bit7

```
-o 2E 87 ;Enter configuration
-o 2E 87
-o 2E 07
-o 2F 09 ;Enable GPIO function
-o 2E 30
-o 2F 02 ;Enable GPIO configuration
-o 2E F0
-o 2F xx ;Set GPIO as input/output; set '1' for input,'0'for
output
-o 2E F1
-o 2F xx ;If set GPIO's as output, in this register its value can
be set
```

Optional:

```
-o 2E F2
-o 2F xx ; Data inversion register; '1' inverts the current value
of the bits,'0' leaves them as they are
-o 2E 30
-o 2F 01 ; active GPIO's
```

For further information, please refer to Winbond W83627DHG datasheet.

Appendix E <Programming Watchdog Timer>

The watchdog timer makes the system auto-reset while it stops to work for a period.

The integrated watchdog timer can be setup as system reset mode by program.

Timeout Value Range

- 1 to 255
- Second or Minute

Program Sample

Watchdog timer setup as system reset with 5 second of timeout

2E, 87	
2E, 87	Entry Key
2E, 07	
2F, 08	Logical Device 8
2E, 30	
2F, 01	Activate
2E, F5	
2F, 00	Set as Second*
2E, F6	
2F, 05	Set as 5

* Minute: bit 3 = 0; Second: bit 3 = 1

You can select Timer setting in the BIOS, after setting the time options, the system will reset according to the period of your selection.



Contact Information

Any advice or comment about our products and service, or anything we can help you please don't hesitate to contact with us. We will do our best to support you for your products, project a business.

Taiwan Commate Computer Inc.

Address	19F No. 94, Sec. 1, Shin Tai Wu Rd., Shi Chih Taipei Hsien, Taiwan
TEL	+886-2-26963909
FAX	+886-2-26963911
Website	http://www.commell.com.tw
E-Mail	info@commell.com.tw (General Information) tech@commell.com.tw (Technical Support)

Commell is a brand name of Taiwan Commate Computer Inc.