

# LS-573

---

## 5.25" Embedded Miniboard

### User's Manual

Edition 1.3

2015/3/18

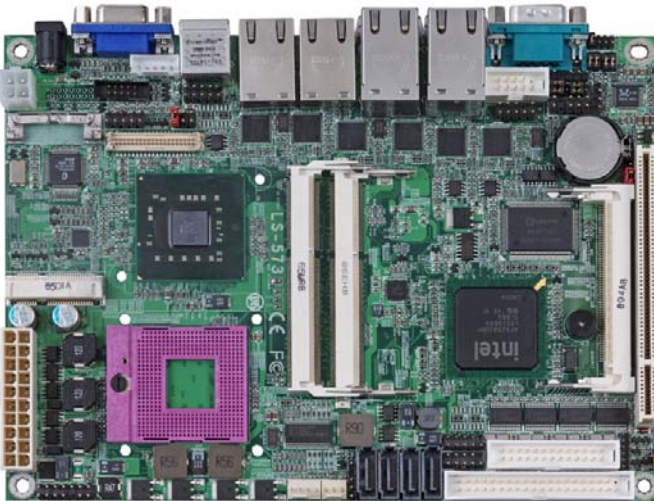

## **Copyright**

Copyright 2008, all rights reserved. This document is copyrighted and all rights are reserved. The information in this document is subject to change without prior notice to make improvements to the products.

This document contains proprietary information and protected by copyright. No part of this document may be reproduced, copied, or translated in any form or any means without prior written permission of the manufacturer.

All trademarks and/or registered trademarks contains in this document are property of their respective owners.

## **Disclaimer**

The company shall not be liable for any incidental or consequential damages resulting from the performance or use of this product.

The company does not issue a warranty of any kind, express or implied, including without limitation implied warranties of merchantability or fitness for a particular purpose.

The company has the right to revise the manual or include changes in the specifications of the product described within it at any time without notice and without obligation to notify any person of such revision or changes.

## **Trademark**

All trademarks are the property of their respective holders.

---

Any questions please visit our website at <http://www.commell.com.tw>

## Packing List:

Please check the package content before you starting using the board.

### Hardware:

LS-573 Embedded Miniboard x 1

### Cable Kit:



Printer Port Cable x 1  
(OAL1P-B)



COM port Cable x 1  
(OAL1SNB)



HD Audio Port Cable x 1  
(OALPJ-HD-NB)



DVI module with DVI Cable x 1  
(BADPDVI\_A + OALDVI-P)  
(Only LS-573TXD)

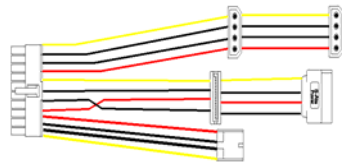

ATX Power Output Cable x 1  
(OALATX-P3S2)



HDTV cable x 1 (Optional)  
(OALTVOUT-H)



Quad COM ports DB9 male Cable x 1  
(OAL4S-B)



SATA Cable x 2  
(OAL1SATA)



USB Cable x 2  
(OALUSBA-3)



CRT cable x 1  
(OAL-10PCRT)  
(Only LS-573TXD)



CPU Cooler x 1  
(OHS-P-M-3)

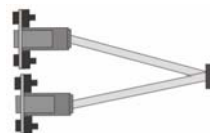

SDTV cable x 1 (Optional)  
(OALTV-OUT)

### Printed Matters:

Driver CD x 1 (Including User's Manual)

# Index

<b>Chapter 1 &lt;Introduction&gt;</b> .....	6
1.1 <Product Overview>.....	6
1.2 <Product Specification> .....	7
1.3 <Mechanical Drawing> .....	9
1.4 <Block Diagram> .....	10
<b>Chapter 2 &lt;Hardware Setup&gt;</b> .....	11
2.1 <Connector Location > .....	11
2.1.1 <LS-573T2X > .....	11
2.1.2 <LS-573TXD >.....	12
2.1.3 < Real IO > .....	12
2.2 <Jumper Location & Reference>.....	13
2.3 <Connector Reference> .....	15
2.3.1 <Internal Connectors>.....	15
2.3.2 <External Connectors> .....	15
2.4 <CPU and Memory Setup> .....	16
2.4.1 <CPU Setup> .....	16
2.4.2 <Memory Setup> .....	17
2.5 <CMOS Setup> .....	18
2.6 <Serial ATA Interface> .....	19
2.7 <Ethernet Interface> .....	20
2.8 <Onboard Display Interface> .....	21
2.8.1 <Digital Display>.....	22
2.8.2 <HDTV Interface> .....	26
2.9 <Integrated Audio Interface>.....	27
2.10 <GPIO Interface> .....	29
2.11 <Power Supply> .....	30
2.11.1 <DC_IN Input> .....	30

2.11.2 <ATX Output> .....	31
2.11.3 <ATX Power Mode> .....	32
2.12 <Switch and Indicator>.....	33
<b>Chapter 3 &lt;System Setup&gt; .....</b>	<b>34</b>
3.1 <Audio Configuration> .....	34
3.2 <Video Memory Setup> .....	35
3.3 <Display Properties Setting>.....	36
<b>Chapter 4 &lt;BIOS Setup&gt; .....</b>	<b>38</b>
<b>Appendix A &lt;I/O Port Pin Assignment&gt;.....</b>	<b>40</b>
A.1 <Serial ATA Port> .....	40
A.2 <IrDA Port> .....	40
A.3 <SMBUS Port>.....	40
A.4 <Serial Port 2>.....	41
A.5 <Parallel Port> .....	42
A.6 <LAN Port> .....	42
A.7 <USB Interface> .....	42
A.8 <COM3/4/5/6 Port>.....	43
A.9 <DVI Port> .....	44
A.10 <CRT Port>.....	44
<b>Appendix B &lt;Flash BIOS&gt;.....</b>	<b>45</b>
B.1 <Flash Tool> .....	45
B.2 <Flash BIOS Procedure> .....	45
<b>Appendix C &lt;System Resources&gt;.....</b>	<b>46</b>
C.1 <Direct Memory Access (DMA)>.....	46
C.2 <Input /Output (IO)>.....	46
C.3 <Memory Address Map>.....	49
<b>Appendix D &lt;Programming GPIO's&gt;.....</b>	<b>51</b>
<b>Appendix E &lt;Programming Watchdog Timer&gt;.....</b>	<b>52</b>
<b>Contact Information.....</b>	<b>53</b>

(This page is left for blank)

## **Chapter 1 <Introduction>**

### **1.1 <Product Overview>**

**LS-573** the new generation of the 5.25" Miniboard, supports Intel Penryn Processor for 667/800/1066 MHz front side bus and features Intel GM45 and ICH9M chipset, integrated GMA X4500 graphics, DDR3 memory, REALTEK ALC888 High Definition Audio, Serial ATA and six Intel Gigabit LAN.

#### **Intel Penryn Processor**

The board supports Intel Penryn processor with 667/800/1066 MHz front side bus, L2 Cache: All specification depend on the CPU. (1M/2M/3M/4M/6M). To provided more powerful performance than before.

#### **New features for Intel GM45 chipset**

The board integrates Intel GM45 and ICH9M chipset, to provide new generation of the mobile solution, supports Intel GMA X4500 graphics, DDR3 800/1066MHz memory, built-in high speed mass storage interface of serial ATA, High Definition Audio with 2 channels surrounding sound.

#### **All in One multimedia solution**

Based on Intel GM45 and ICH9M chipset, the board provides high performance onboard graphics, 24-bit dual channel LVDS interface, HDTV and 2 channels High Definition Audio, to meet the very requirement of the multimedia application.

#### **Flexible Extension Interface**

The board provides one mini PCI Express, one mini-PCI socket and one PCI slot.

## 1.2 <Product Specification>

### General Specification

Form Factor	5.25 Inches Embedded Miniboard
CPU	Support Intel Penryn Processor Package type: Micro-FCPGA478 (Socket-P) L2 Cache: All specification depend on the CPU. (1M/2M/3M/4M/6M) Front side bus: 667/800/1066 MHz
Memory	2 x 800/1066MHz DDRIII 204-pin SO-DIMM up to 8GB
Chipset	Intel® GM45 and ICH9M (82801IBM)
BIOS	Phoenix-Award v6.00PG 8Mb SPI flash BIOS
Green Function	Power saving mode includes doze, standby and suspend modes. ACPI version 1.0 and APM version 1.2 compliant
Watchdog Timer	System reset programmable watchdog timer with 1 ~ 255 sec./min. of timeout value
Real Time Clock	Chipset integrated RTC with onboard lithium battery
Serial ATA	Intel® ICH9M built-in 4 x Serial ATAII interface up to 300MB/s

### Multi-I/O Port

Chipset	Intel® ICH9M with Winbond® W83627DHG controller
Serial Port	Five RS232 and one jumper selectable RS232/422/485/IR
USB Port	8 x Hi-Speed USB 2.0 ports with 480Mbps of transfer rate
IrDA Port	One IrDA compliant Infrared interface supports SIR
K/B & Mouse	PS/2 keyboard and mouse port on bracket
GPIO	One 12-pin Digital I/O connector with 8-bit programmable
Smart Fan	One CPU fan connectors for fan speed controllable

### VGA Display Interface

Chipset	Intel® GM45 & ICH9M
Memory	Up to 384MB shared with system memory
Display Type	CRT, LCD monitor with analog display, DVI or LVDS
Connector	External DB15 female connector Onboard 40-Pin LVDS connector Onboard 10-Pin DB15 connector(LS-573T2X Only) Onboard 26-Pin DVI connector (LS-573TXD Only)

### Ethernet Interface

Chipset	Intel 82573L Gigabit Ethernet controller
Type	Triple speed 10/100/1000Base-T auto-switching Fast Ethernet Full duplex, IEEE802.3U compliant
Connector	External six RJ45 connector with LED

### Audio Interface

Chipset	Intel® ICH9M with Realtek ALC888 HD Audio
---------	---



## LS-573 User's Manual

---

	Intel High Definition Audio compliance
Interface	2 channels sound output
Connector	Internal 10-pin header for line-in/-out, MIC-in, 4-pin header for CD-IN

### Power and Environment

Power Requirement	Standard 20-Pin ATX power supply or 9V~24V DC Input
Dimension	203 (L) x 146 (W) mm
Temperature	Operating within 0 ~ 60°C (32 ~ 140°F) Storage within -20 ~ 85°C (-4 ~ 185°F)

### Ordering Code

LS-573TX	Onboard CRT, LVDS, HDTV, 6 x Intel Gigabit LAN, 8 x USB2.0, PCI, Mini-PCI, GPIO, IrDA, PCI Express mini card, Parallel, RS232/422/485, 4 x SATA, HD Audio and SMBus, PCI
LS-573T2X	Onboard <b>2 x CRT</b> , LVDS, HDTV, 6 x Intel Gigabit LAN, 8 x USB2.0, PCI, Mini-PCI, GPIO, IrDA, PCI Express mini card, Parallel Port, RS232/422/485, 4 x SATA, HD Audio and SMBus, PCI
LS-573TXD	Onboard CRT, HDTV, 6 x Intel Gigabit LAN, 8 x USB2.0, PCI, Mini-PCI, GPIO, IrDA, PCI Express mini card, Parallel, RS232/422/485, 4 x SATA, HD Audio and SMBus, <b>DVI</b> , PCI

The specifications may be different as the actual board.

For further product information please visit the website at

<http://www.commell.com.tw>

---

### 1.3 <Mechanical Drawing>

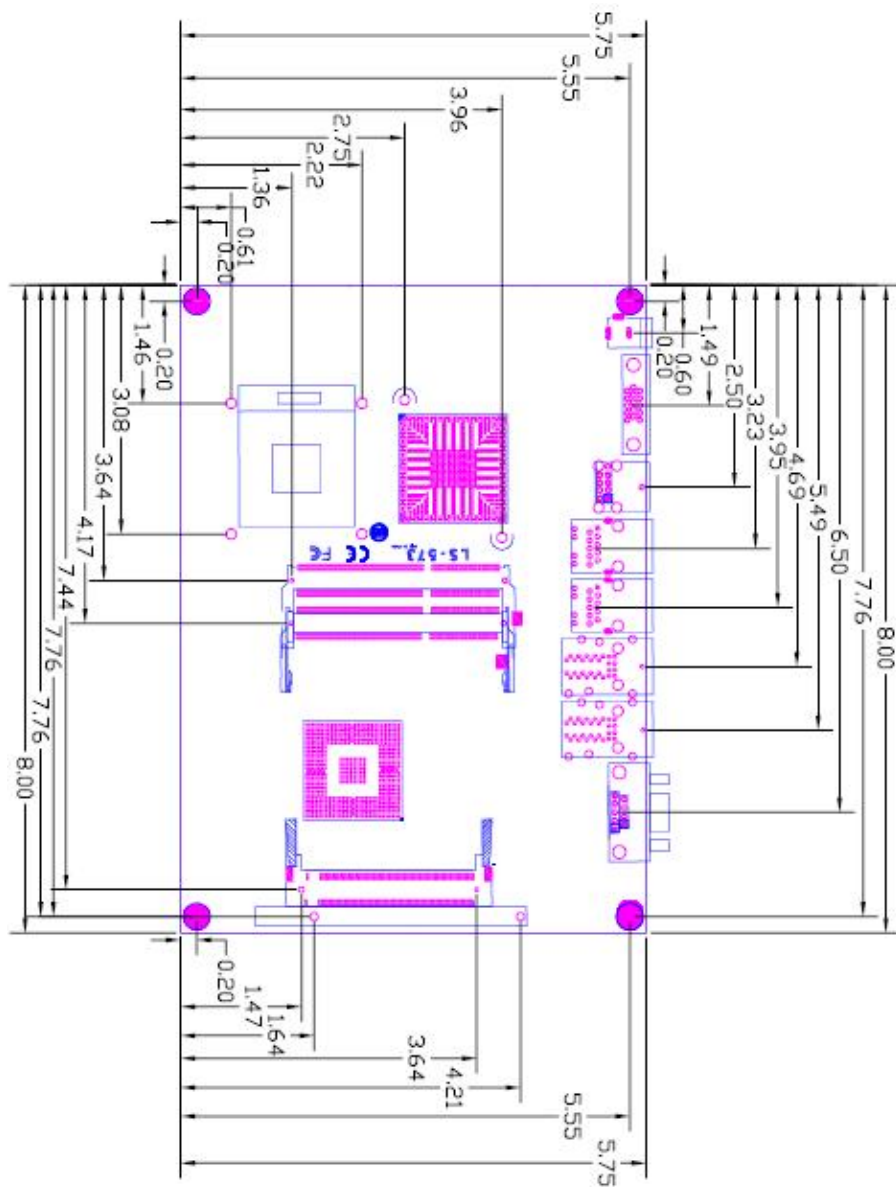

# 1.4 <Block Diagram>

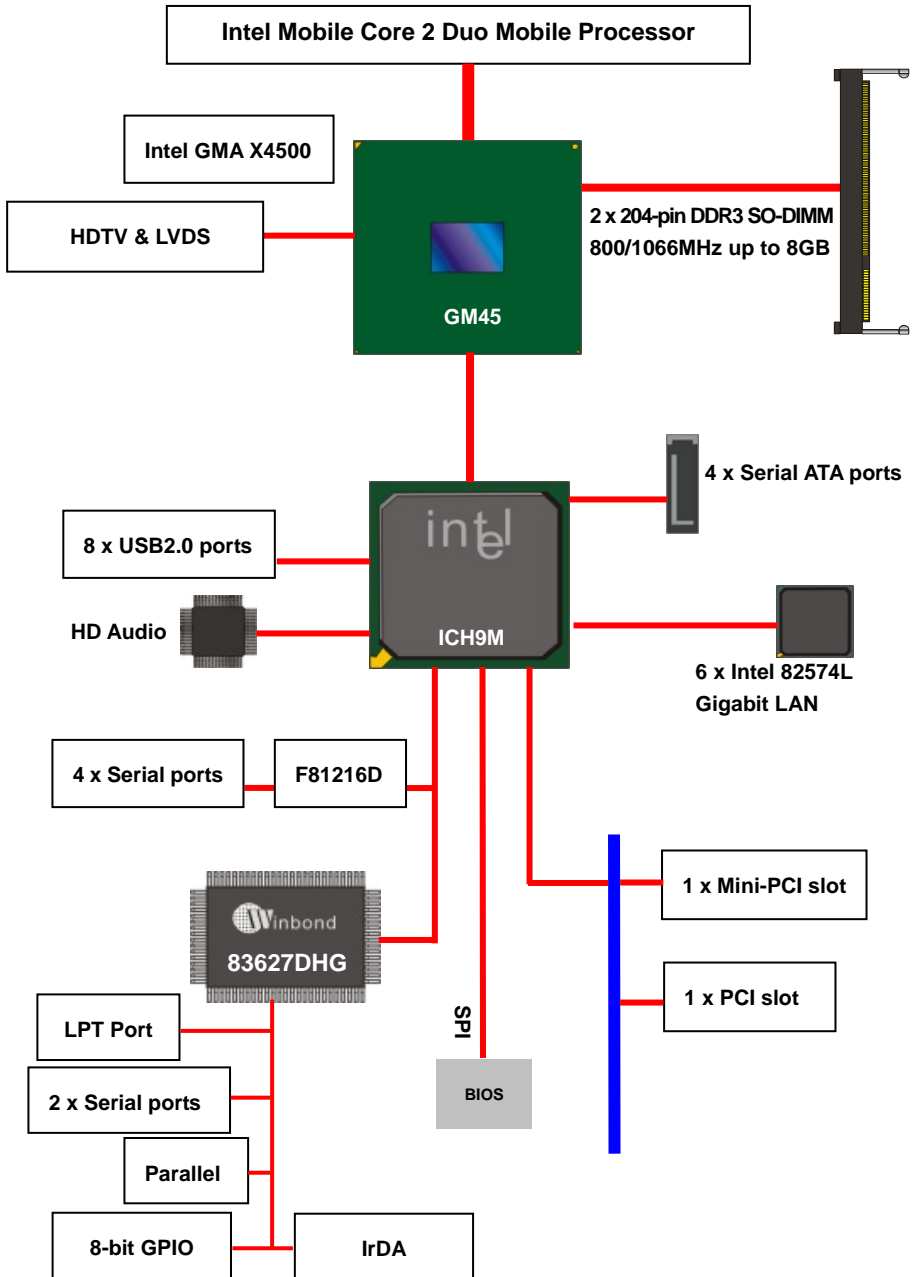

# Chapter 2 <Hardware Setup>

## 2.1 <Connector Location >

### 2.1.1 < LS-573T2X >

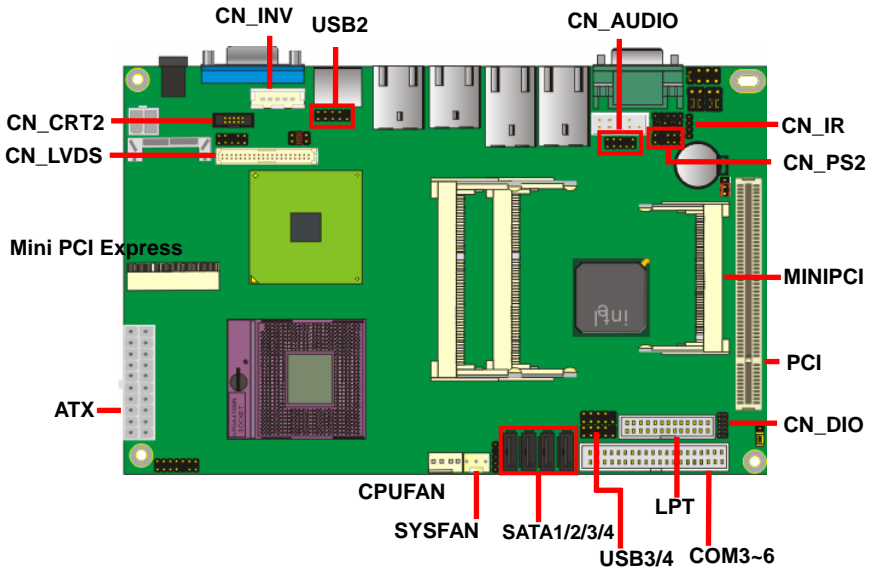

2.1.2 < LS-573TXD >

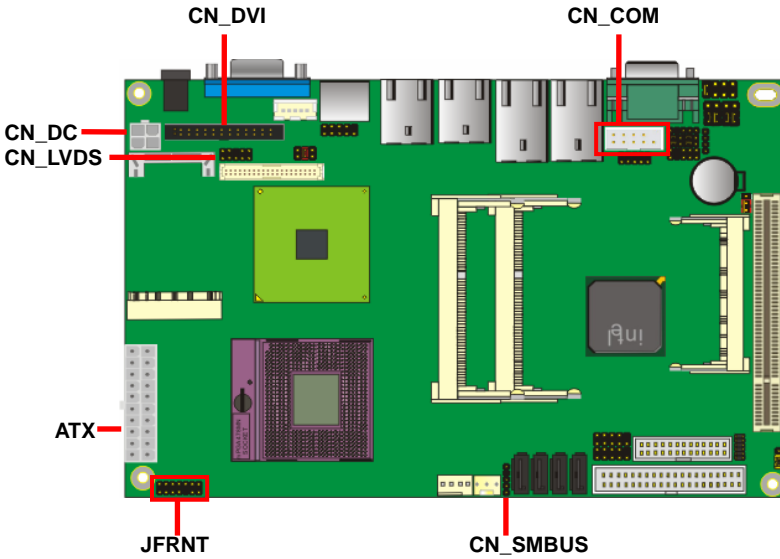

2.1.3 < Real IO >

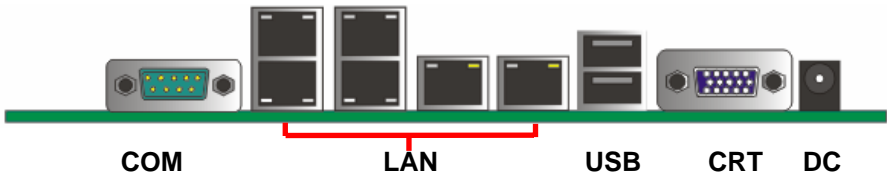

## 2.2 <Jumper Location & Reference>

Jumper	Function
JRTC	CMOS Operating/Clear Setting
JVLCD	Panel Voltage Setting
JAT	Power mode select
JP1	COM1 signal mode switch (For Pin-1 & Pin-9)
JP2	COM2 signal mode switch (For Pin-1 & Pin-9)
JCSEL1	CN_COM2 RS-232 RS422 RS485 Setting / CN_IR IrDA Setting
JCSEL2	Setting

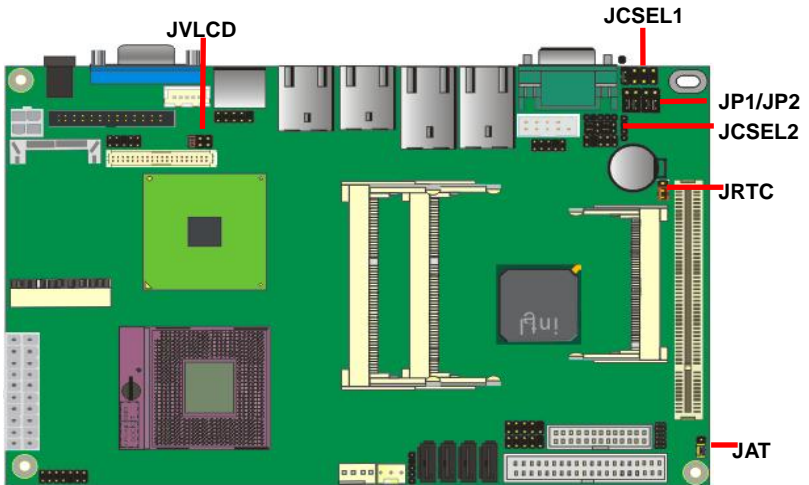

Jumper: **JAT**

Type: onboard 3-pin header

Power Mode	JAT
AT Mode	1-2
ATX Mode	2-3
Default setting:	2-3 

Jumper: **JP1 (COM 1)**

Type: onboard 3 x 2-pin header

Power Mode	JP1
Standard COM Port	3-5,4-6
Pin1 with 5V signal Pin9 with 12V signal	1-3,4-6 2-4,3-5
Default setting:	3-5, 4-6 

Jumper: **JP2 (COM 2)**

Type: onboard 3 x 2-pin header

Power Mode	JP2
Standard COM Port	3-5,4-6
Pin1 with 5V signal Pin9 with 12V signal	1-3,4-6 2-4,3-5
Default setting:	3-5, 4-6 

## 2.3 <Connector Reference>

### 2.3.1 <Internal Connectors>

Connector	Function	Remark
CPU	Socket 478 for <b>socket-P</b> CPU	
SO-DIMM	204-pin DDR3 SO-DIMM slot	
LPT	26-pin LPT port connector	
SATA1/2/3/4	7-pin Serial ATA connector	
DC_IN	4-pin DC 12V input connector	DC input Mode
ATX	20-pin power input connector (ATX 20-pin power output)	ATX input Mode (DC output Mode)
CN_AUDIO	5 x 2-pin audio connector	
CN_PS2	PS/2 keyboard and mouse connector	
CD_IN	4-pin CD-ROM audio input connector	
CN_DIO	6 x 2-pin digital I/O connector	
CN_USB	5 x 2-pin USB connector	
CPUFAN	4-pin CPU cooler fan connector	
SYSFAN	3-pin system cooler fan connector	
CN_DVI	13 x 2-pin DVI interface	<b>(Only LS-573TXD)</b>
CN_HDTV	5 x 2-pin HDTV interface	
CN_LVDS	20 x 2-pin LVDS connector	
CN_INV	5-pin LCD inverter connector	
CN_IR	5-pin IrDA connector	
JFRNT	14-pin front panel switch/indicator connector	
MiniPCI	Mini-PCI socket Type IIIA	
PCI	32-bit PCI slot	
COM 3/4/5/6	Serial port connector	
CN_CRT2	5 x 2 pin CRT interface	<b>(Only LS-573T2X)</b>

### 2.3.2 <External Connectors>

Connector	Function	Remark
CRT	DB15 VGA connector	
RJ45	Six RJ45 LAN connector	
USB	Dual USB 2.0 connector	
COM 1	DB9 Serial port connector	
DC_2P	DC 9~24V input jack	



## 2.4 <CPU and Memory Setup>

### 2.4.1 <CPU Setup>

The board comes with the socket 478 for Intel Core 2 Duo **socket-P** processor only it supports new generation with 667/800/1066 MHz of front side bus. Please follow the instruction to install the CPU properly.

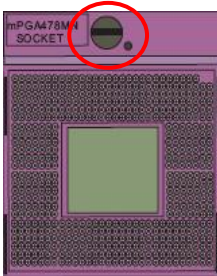

1. Use the flat-type screw drive to unlock the CPU socket

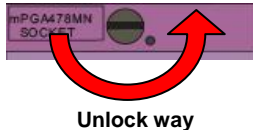

Unlock way

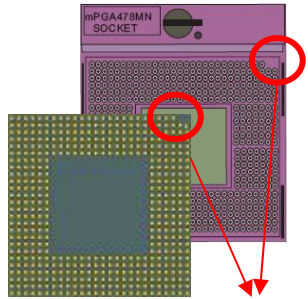

Check point

2. Follow the pin direction to install the processor on the socket

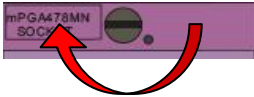

3. Lock the socket

4. Socket P has 478 pins, but is not pin-compatible with Socket M

CPU.

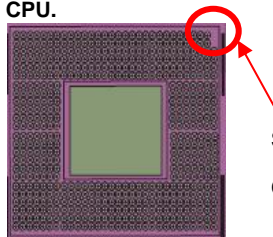

Socket-M CPU

Check point

### 2.4.2 <Memory Setup>

The board provides two 204-pin DDR3 SO-DIMM to support 800/1066 MHz memory module up to 8GB. Non-ECC, unbuffered memory is supported only, dual channel technology is enabled automatically for higher performance.

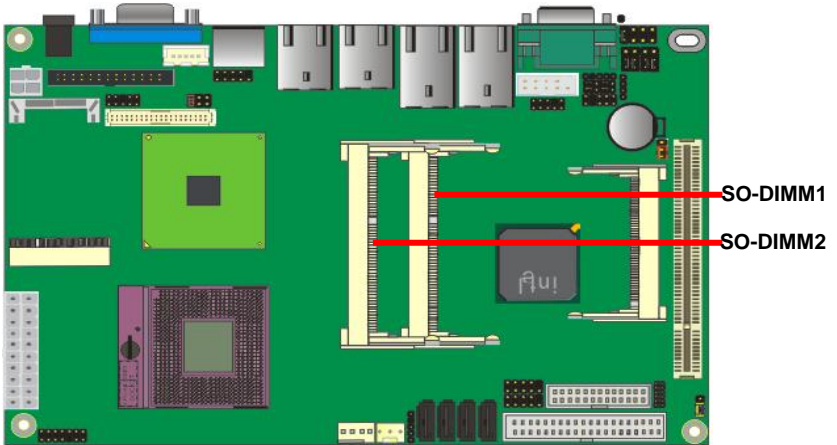

## 2.5 <CMOS Setup>

The board's data of CMOS can be setting in BIOS. If the board refuses to boot due to inappropriate CMOS settings, here is how to proceed to clear (reset) the CMOS to its default values.

**Jumper: JRTC**

**Type: Onboard 3-pin jump**

JRTC	Mode
1-2	Clear CMOS
2-3	Normal Operation

Default setting: 2-3

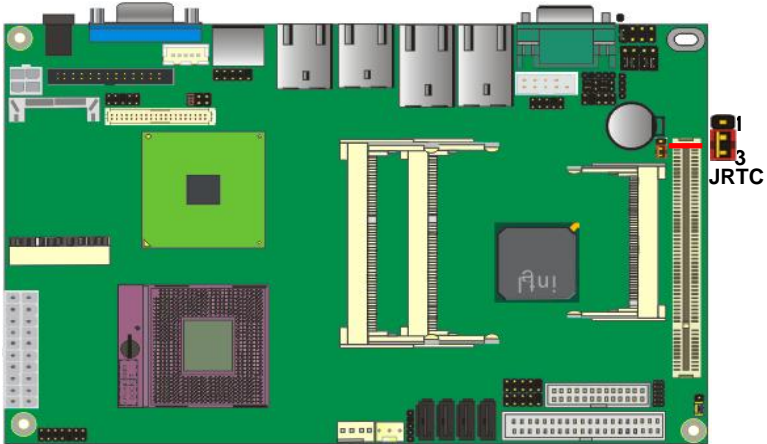

## 2.6 <Serial ATA Interface>

Based on Intel ICH9M, the board provides four Serial ATAII interfaces with up to 300MB/s of transfer rate.

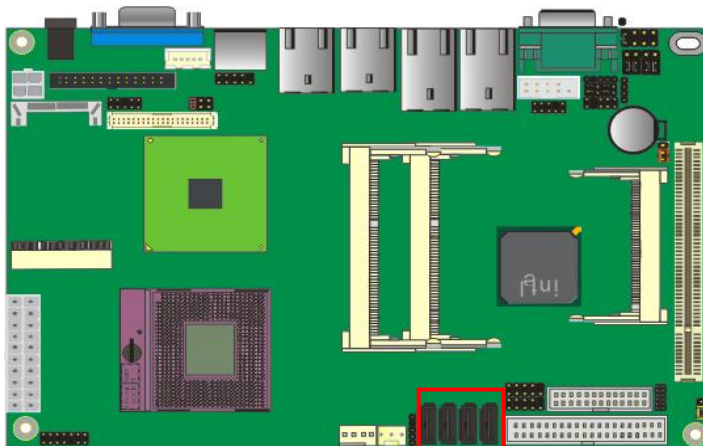

SATA1/2/3/4

## 2.7 <Ethernet Interface>

The board integrates with two Intel 82574L Gigabit Ethernet controllers. The Intel Gigabit Ethernet supports triple speed of 10/100/1000Base-T, with IEEE802.3 compliance and Wake-On-LAN supported.

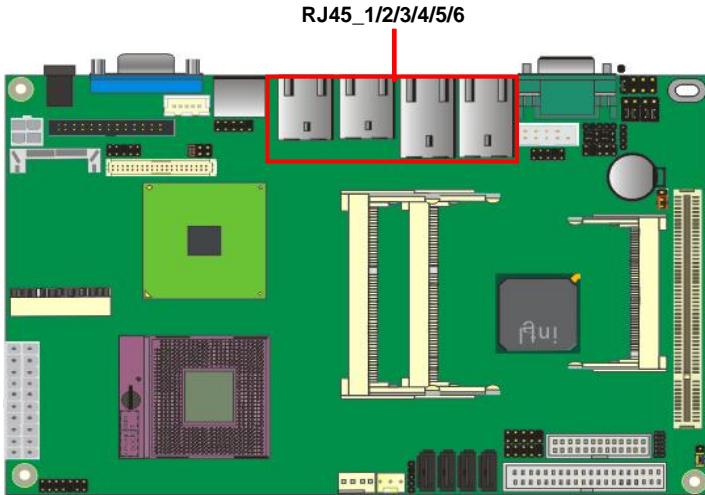

## 2.8 <Onboard Display Interface>

Based on Intel GM45 chipset with built-in GMA (Graphic Media Accelerator) X4500 graphics, the board provides, 40-pin LVDS interface with 5-pin LCD backlight inverter connector. The board provides dual display function with clone mode and extended desktop mode for VGA, LVDS, HDTV and DVI.

2 x VGA type: **(LS-573T2X)**

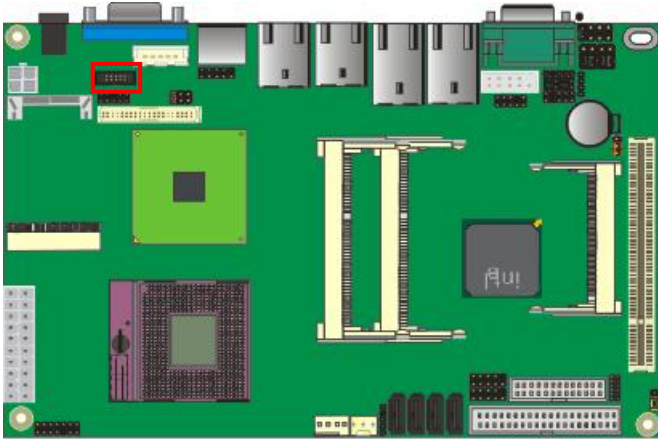

1 x DVI type: **(LS-573TXD)**

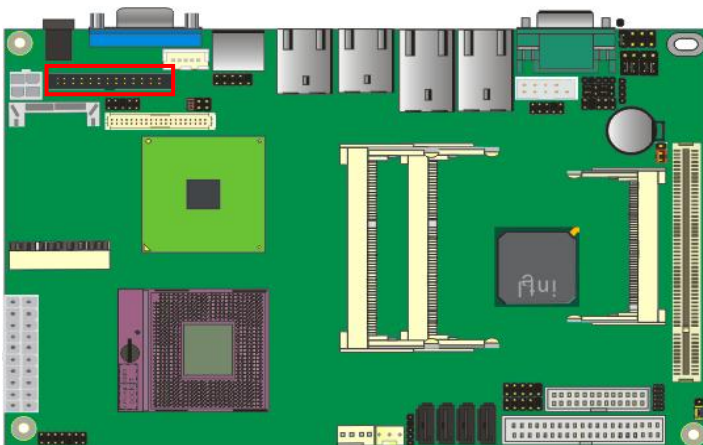

### 2.8.1 <Digital Display>

The board provides one 40-pin LVDS connector up to two mode for 18/24-bit single/dual channel panels, supports up to 1600 x 1200 (UXGA) resolution, with LCD backlight inverter connector and jumper for panel voltage setting.

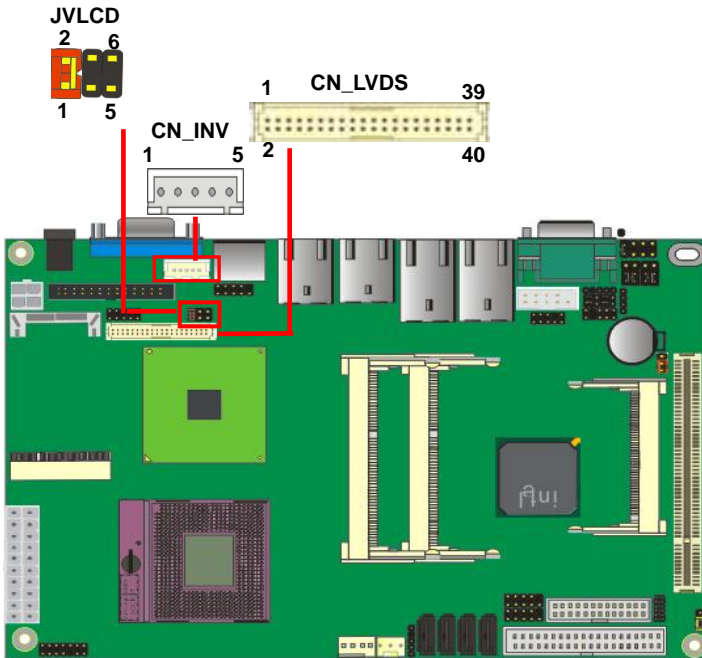

**Effective patterns of connection: 1-2 / 3-4 / 5-6**

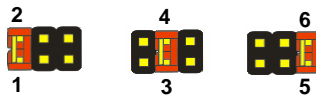

**Warning: others cause damages**

Connector: **CN\_INV**

Type: 5-pin LVDS Power Header

Pin	Description
1	+12V
2	Reserved (Note)
3	GND
4	GND
5	ENABKL

Note: Reserved for MB internal test  
Please treat it as NC.

Connector: **JVLCD**

Type: 6-pin Power select Header

Pin	Description
1-2	LCDVCC (3.3V)
3-4	LCDVCC (5V)
5-6	LCDVCC (12V)

Default: 1-2

Connector: **CN\_LVDS**

Type: onboard 40-pin connector for LVDS connector

Connector model: **HIROSE DF13-40DP-1.25V**

Pin	Signal	Pin	Signal
2	LCDVCC	1	LCDVCC
4	GND	3	GND
6	ATX0-	5	BTX0-
8	ATX0+	7	BTX0+
10	GND	9	GND
12	ATX1-	11	BTX1-
14	ATX1+	13	BTX1+
16	GND	15	GND
18	ATX2-	17	BTX2-
20	ATX2+	19	BTX2+
22	GND	21	GND
24	ACLK-	23	BTX3-
26	ACLK+	25	BTX3+
28	GND	27	GND
30	ATX3-	29	BCLK-
32	ATX3+	31	BCLK+
34	GND	33	GND
36	DDCPCLK	35	N/C
38	DDCPDATA	37	N/C
40	N/C	39	N/C



## LS-573 User's Manual

---

To setup the LCD, you need the component below:

1. A panel with LVDS interfaces.
2. An inverter for panel's backlight power.
3. A LCD cable and an inverter cable.

For the cables, please follow the pin assignment of the connector to make a cable, because every panel has its own pin assignment, so we do not provide a standard cable; please find a local cable manufacture to make cables.

### LCD Installation Guide:

1. Preparing the **LS-573, LCD panel** and the **backlight inverter**.

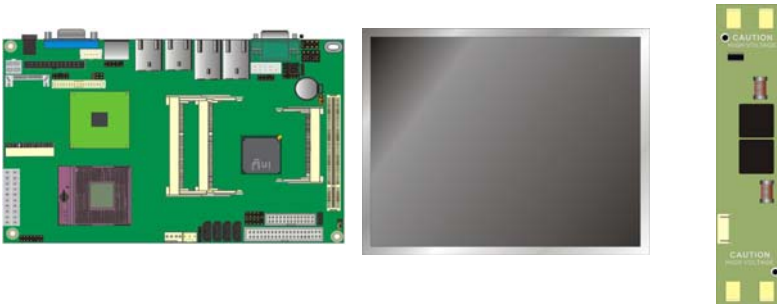

2. Please check the datasheet of the panel to see the voltage of the panel, and set the jumper **JVLCD** to +12V or +5V or +3.3V.
3. You would need a LVDS type cable.

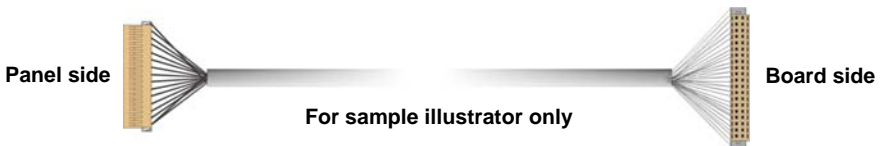

4. To connect all of the devices well.

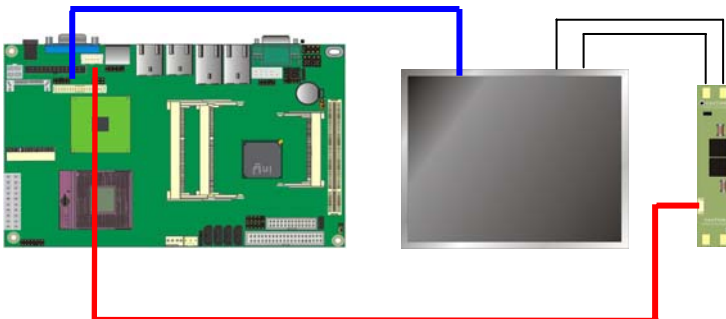

After setup the devices well, you need to select the LCD type in the BIOS.

The panel type mapping is list below:

<b>BIOS panel type selection form (BIOS Version:1.0)</b>			
<b>18-bit Single channel</b>		<b>24-bit Dual channel</b>	
<b>NO.</b>	<b>Output format</b>	<b>NO.</b>	<b>Output format</b>
1	640 x 480	11	1280 x 768
2	800 x 480	12	1280 x 1024
3	800 x 600	13	1600 x 1200
4	1024 x 768	14	1920 x 1080
5	1280 x 800	15	1920 x 1200
<b>18-bit Dual channel</b>			
6	1280 x 768		
<b>24-bit Single channel</b>			
7	1024 x 768		
8	1280 x 768		
9	1280 x 800		
10	1366 x 768		

### 2.8.2 <HDTV Interface>

The board provides an HDTV interface with Intel GM45, supports Composite, S-Video and Component with PAL and NTSC of TV system, and display (clone or extended desktop) function with VGA, LVDS, DVI.

Connector: **CN\_HDTV**



Connector type: 10-pin header HDTV connector (pitch = 2.54mm)

Pin Number	Assignment	Pin Number	Assignment
1	GND	2	DACB_L
3	DACC_L	4	GND
5	GND	6	N/C
7	DACA_L	8	GND
9	N/C	10	N/C

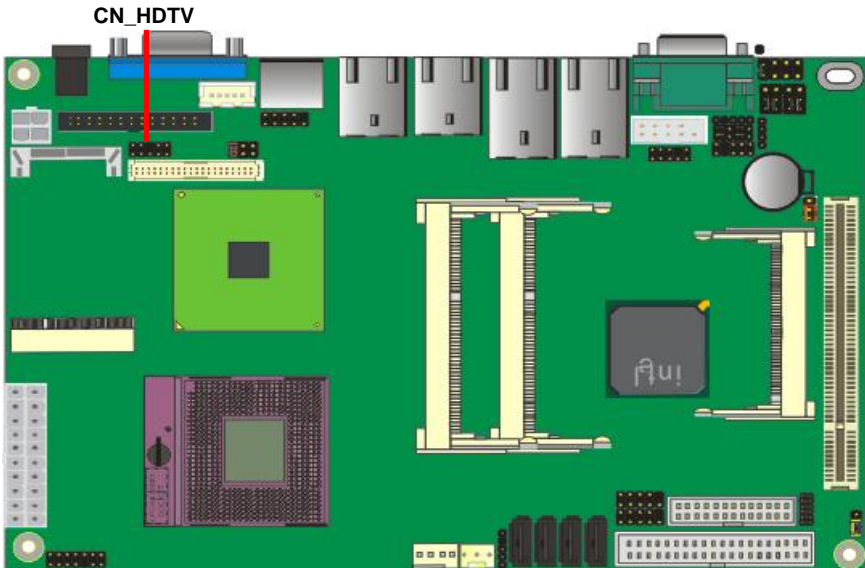

## 2.9 <Integrated Audio Interface>

The board integrates onboard audio interface with REALTEK ALC888 codec, with Intel next generation of audio standard as High Definition Audio, it offers more sound and other advantages than former HD audio compliance.

The main specifications of ALC888 are:

- **High-performance DACs with 97dB SNR (A-Weighting),**
- **Ten DAC channels support 16/20/24-bit PCM format for 2 sound playback, plus 2 channels of independent stereo sound output (multiple streaming) through the front panel output**
- **High-quality analog differential CD input**
- **Meets performance requirements for Microsoft WLP 3.0 Premium desktop and mobile PCs**

The board provides 2 channels audio speaker out and Mic-In ports for front I/O panel through cable.

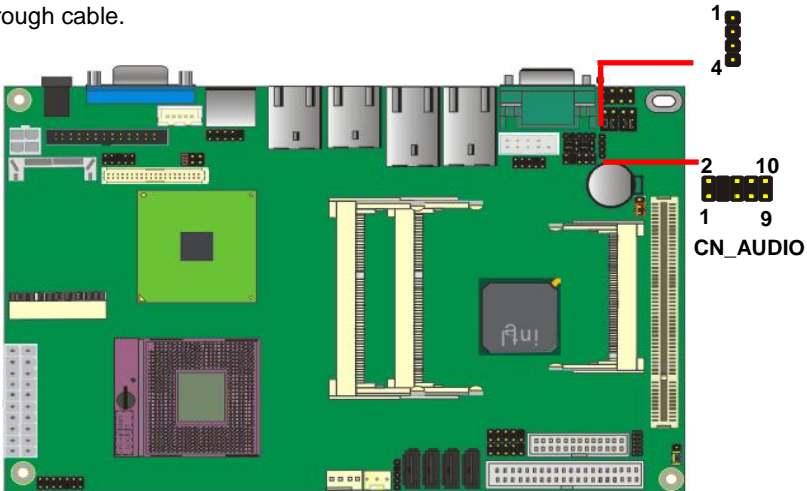

**Connector: CN\_AUDIO**

Type: 10-pin (2 x 5) 2.54mm-pitch header

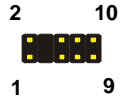

Pin	Description	Pin	Description
1	MIC2_L	2	Ground
3	MIC2_R	4	VCC
5	FP_OUT_R	6	MIC2_JD
7	SENSE_B	8	N/C
9	FP_OUT_L	10	LINE2_JD

**Connector: CD\_IN**

Type: 4-pin header (pitch = 2.54mm)



Pin	Description
1	CD – Left
2	Ground
3	Ground
4	CD – Right

## 2.10 <GPIO Interface>

The board provides a programmable 8-bit digital I/O interface; you can use this general purpose I/O port for system control like POS or KIOSK.

Connector: **CN\_DIO**

Type: 12-pin (6 x 2) 2.0mm-pitch header

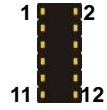

Pin	Description	Pin	Description
1	Ground	2	Ground
3	GP10	4	GP14
5	GP11	6	GP15
7	GP12	8	GP16
9	GP13	10	GP17
11	VCC	12	+12V

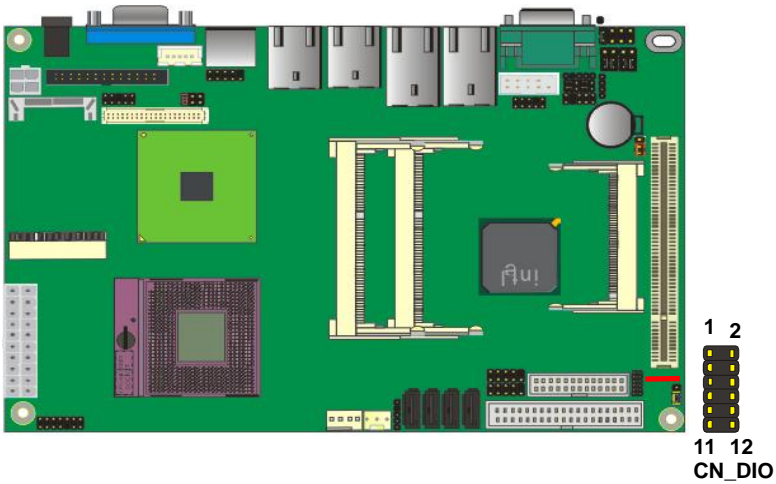

## 2.11 <Power Supply>

### 2.11.1 <DC\_IN Input>

The board requires 4-pin DC 12V input or onboard 20-pin ATX2.0, for the input current, please take a reference of the power consumption report on appendix.

Connector: **DC\_IN**

Type: 4-pin DC power connector

Pin	Description	Pin	Description
1	Ground	2	Ground
3	+12V	4	+12V

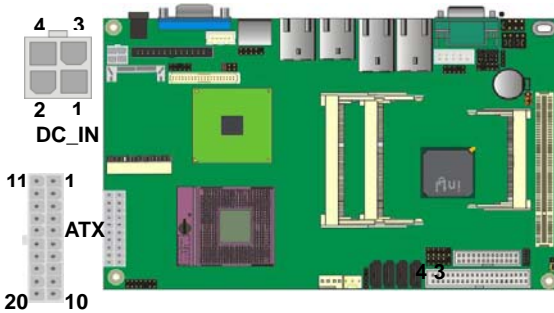

ATX power output cable to powering device.

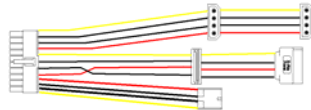

▪ **DC Input Mode**

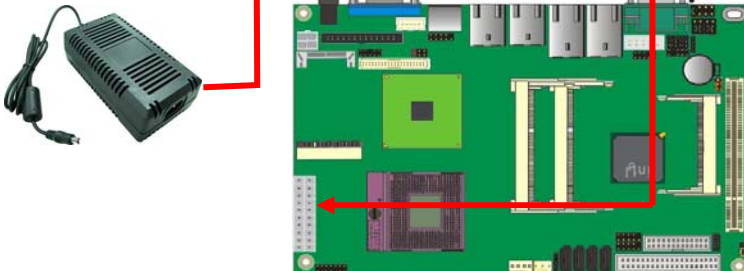

### 2.11.2 <ATX Output>

The board provides one 20-pin ATX connector for +5V/+12V output for powering your HDD, CDROM or other devices when DC-input mode has been used.

**Attention: When DC-IN had power supplied, the ATX become output !**

**Avoid DC-IN and ATX power supply input at the same time !**

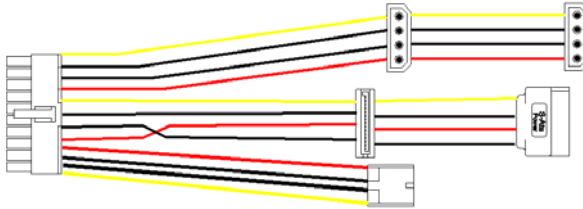

Connector: **ATX Output** (When DC-IN be used)

Type: 20-pin ATX connector for +5V/+12V

PIN	Assignment	PIN	Assignment
1	*	13	*
2	*	14	*
3	*	15	*
4	5V	16	*
5	GND	17	*
6	*	18	GND
7	GND	19	GND
8	*	20	*
9	*	21	*
10	12V	22	5V

Note: Maximum output voltage: **12V/2A & 5V/3A**



### 2.11.3 <ATX Power Mode>

Connector: **ATX** (It also can become Output when DC-IN be used)

Type: 20-pin ATX power connector

PIN	Assignment	PIN	Assignment
1	3.3V	11	3.3V
2	3.3V	12	-12V
3	GND	13	GND
4	5V	14	PS_ON
5	GND	15	GND
6	5V	16	GND
7	GND	17	GND
8	PW_OK	18	-5V
9	5V_SB	19	5V
10	12V	20	5V

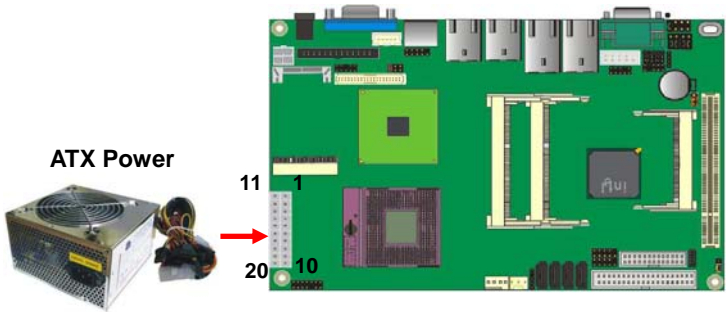

## 2.12 <Switch and Indicator>

The **JFRNT** provides front control panel of the board, such as power button, reset and beeper, etc. Please check well before you connecting the cables on the chassis.

Connector: **JFRNT**

Type: onboard 14-pin (2 x 7) 2.54-pitch header

Function	Signal	PIN		Signal	Function
<b>IDE LED</b>	HDLED+	1	2	PWRLED+	<b>Power LED</b>
	HDLED-	3	4	N/C	
<b>Reset</b>	Reset+	5	6	PWRLED-	<b>Speaker</b>
	Reset-	7	8	SPK+	
N/C		9	10	N/C	
<b>Power Button</b>	PWRBT-	11	12	N/C	
	PWRBT+	13	14	SPK-	

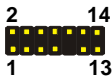
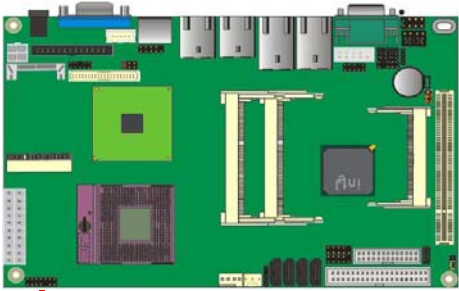

**JFRNT**

## Chapter 3 <System Setup>

### 3.1 <Audio Configuration>

The board integrates Intel® ICH9M with REALTEK® ALC888 codec. It can support 2 channels sound under system configuration. Please follow the steps below to setup your sound system.

1. Install REALTEK HD Audio driver.
2. Launch the control panel and Sound Effect Manager.



3. Select Speaker Configuration



4. Select the sound mode to meet your speaker system.

### 3.2 <Video Memory Setup>

Based on Intel® GM45 chipset with GMA (Graphic Media Accelerator) X4500, the board supports Intel® DVMT (Dynamic Video Memory Technology) 4.0, which would allow the video memory to be allocated up to 384MB.

To support DVMT, you need to install the Intel GMA X4500 Driver with supported OS.

#### BIOS Setup:

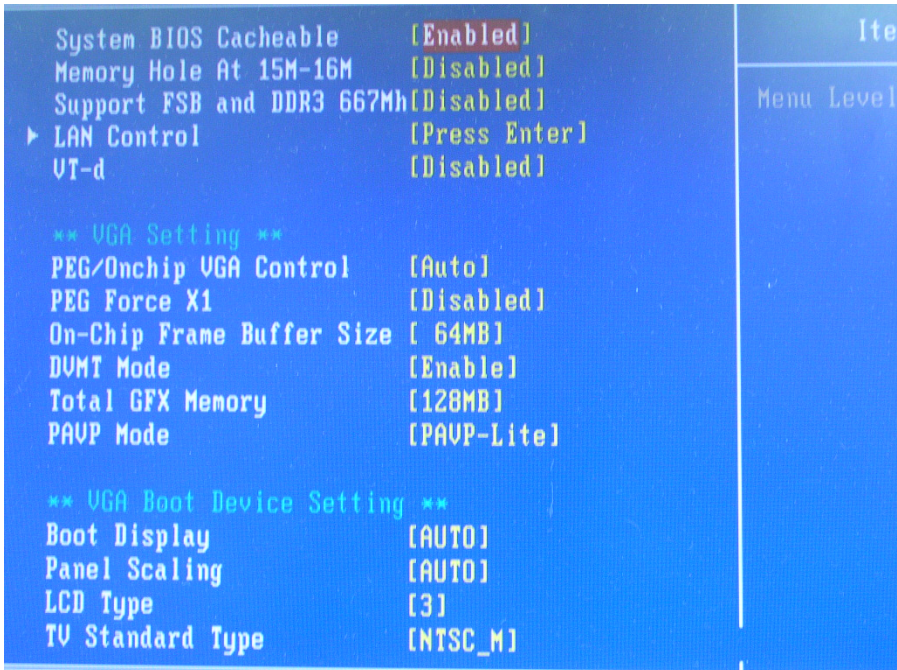

#### Total GFX Memory Size:

This item can let you select a static amount of page-locked graphics memory which will be allocated during driver initialization. Once you select the memory amount, it will be no longer available for system memory.

**DVMT Mode:** This item can let you select graphics memory

### 3.3 <Display Properties Setting>

Based on Intel GM45 GMCH with GMA X4500 (Graphic Media Accelerator), the board supports two DACs for display device as different resolution and color bit. Please install the Intel Graphic Driver before you starting setup display devices.

1. Click right button on the desktop to lunch **display properties**

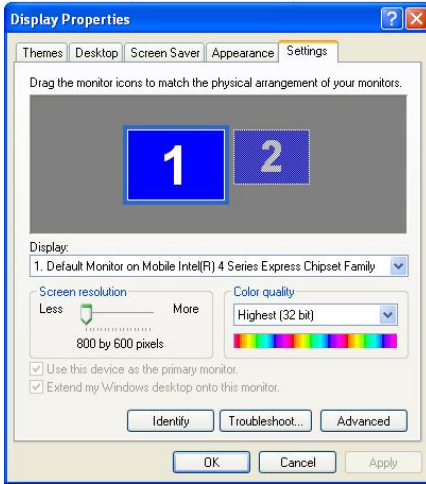

2. Click **Advanced** button for more specificity setup.



Click **Graphics Properties...** for advanced setup

3. This setup options can let you define each device settings.

Click **Monitor** to setup the CRT monitor for Colors, Resolution and Refresh Rate

Click **Intel(R) Dual Display Clone** to setup the dual display mode as same screen

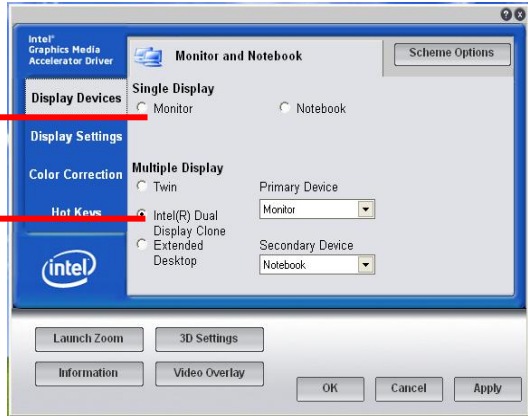

## Chapter 4 <BIOS Setup>

The motherboard uses the Award BIOS for the system configuration. The Award BIOS in the single board computer is a customized version of the industrial standard BIOS for IBM PC AT-compatible computers. It supports Intel x86 and compatible CPU architecture based processors and computers. The BIOS provides critical low-level support for the system central processing, memory and I/O sub-systems.

The BIOS setup program of the single board computer let the customers modify the basic configuration setting. The settings are stored in a dedicated battery-backed memory, NVRAM, retains the information when the power is turned off. If the battery runs out of the power, then the settings of BIOS will come back to the default setting.

The BIOS section of the manual is subject to change without notice and is provided here for reference purpose only. The settings and configurations of the BIOS are current at the time of print, and therefore they may not be exactly the same as that displayed on your screen.

To activate CMOS Setup program, press <DEL> key immediately after you turn on the system. The following message "Press DEL to enter SETUP" should appear in the lower left hand corner of your screen. When you enter the CMOS Setup Utility, the Main Menu will be displayed as **Figure 4-1**. You can use arrow keys to select your function, press <Enter> key to accept the selection and enter the sub-menu.

Figure 4-1 CMOS Setup Utility Main Screen

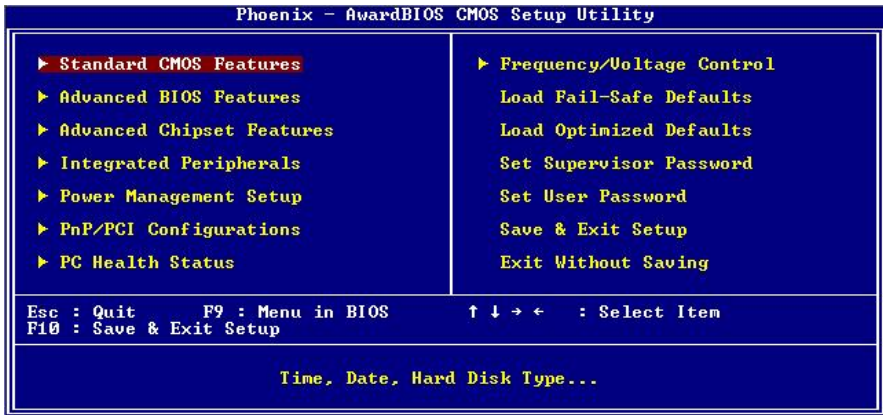

(This page is left for blank)



## Appendix A <I/O Port Pin Assignment>

### A.1 <Serial ATA Port>

Connector: **SATA1/2/3/4**

Type: 7-pin wafer connector

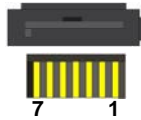

1	2	3	4	5	6	7
GND	SATA_TXP0	SATA_TXN0	GND	SATA_RXN0	SATA_RXP0	GND

### A.2 <IrDA Port>

Connector: **CN\_IR**

Type: 5-pin header for SIR Ports

Pin	Description
1	VCC
2	N/C
3	IRRX
4	Ground
5	IRTX



*JCSEL1 must jump to "IrDA"*

### A.3 <SMBUS Port>

Connector: **CN\_SMBUS**

Type: 5-pin header for SMBUS Ports

Pin	Description
1	V5S
2	N/C
3	SMBDATA
4	SMBCLK
5	Ground



### A.4 <Serial Port 2>

Connector: **CN\_COM2**

Type: 9-pin box header

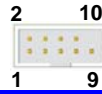

Pin	Description	Pin	Description
1	DCD/422TX-/485-/+5V	2	RX/422TX+/485+
3	TX/422RX+	4	DTR/422RX-
5	Ground	6	DSR
7	RTS	8	CTS
9	RI /+12V		

### Setting RS-232, RS-422, RS-485 & IrDA:

Function	JCSEL1	JCSEL2
IrDA		
RS-422		
RS-485		
RS-232		

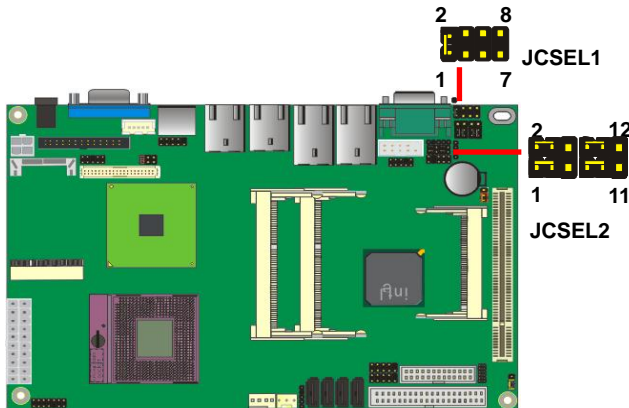

## A.5 <Parallel Port>

Connector: **LPT**

Type: 26-Pin box header

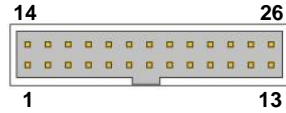

Pin	Description	Pin	Description
1	-PSTB	14	AFD-
2	PRO0	15	ERR-
3	PRO1	16	INT-
4	PRO2	17	SLIN-
5	PRO3	18	Ground
6	PRO4	19	Ground
7	PRO5	20	Ground
8	PRO6	21	Ground
9	PRO7	22	Ground
10	ACK-	23	Ground
11	BUSY	24	Ground
12	PE	25	Ground
13	SLCT	26	N/C

## A.6 <LAN Port>

Connector: **RJ45\_1/2**

Type: RJ45 connector with LED

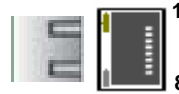

Pin	1	2	3	4	5	6	7	8
Description	MI0+	MI0-	MI1+	MI2+	MI2-	MI1-	MI3+	MI3-

## A.7 <USB Interface>

Connector: **CN\_USB 2/3/4**

Type: 10-pin (5 x 2) header for dual USB Ports



Pin	Description	Pin	Description
1	VCC	2	VCC
3	Data0-	4	Data1-
5	Data0+	6	Data1+
7	Ground	8	Ground
9	Ground	10	N/C

## A.8 <COM3/4/5/6 Port>

Connector: **COM3/4/5/6**

Type: 40-Pin box header



Pin	Description	Pin	Description
1	HS_DCD1	2	HS_RXD1
3	HS_TXD1	4	HS_DTR1
5	Ground	6	HS_DSR1
7	HS_RTS1	8	HS_CTS1
9	HS_RI1	10	N/C
11	HS_DCD2	12	HS_RXD2
13	HS_TXD2	14	HS_DTR2
15	Ground	16	HS_DSR2
17	HS_RTS2	18	HS_CTS2
19	HS_RI2	20	N/C
21	HS_DCD3	22	HS_RXD3
23	HS_TXD3	24	HS_DTR3
25	Ground	26	HS_DSR3
27	HS_RTS3	28	HS_CTS3
29	HS_RI3	30	N/C
31	HS_DCD4	32	HS_RXD4
33	HS_TXD4	34	HS_DTR4
35	Ground	36	HS_DSR4
37	HS_RTS4	38	HS_CTS4
39	HS_RI4	40	N/C

### A.9 <DVI Port>

Connector: **CN\_DVI**

Type: onboard 26-pin connector for DVI connector



Pin	Description	Pin	Description
1	TDC1+	2	TDC1-
3	GND	4	GND
5	TLC+	6	TLC-
7	GND	8	V5S
9	N/C	10	N/C
11	TDC2+	12	TDC2-
13	GND	14	GND
15	TDC0+	16	TDC0-
17	N/C	18	HPD
19	DVI_DA	20	DVI_SL
21	GND	22	BR
23	BG	24	BB
25	5HSYNC	26	5VSYNC

### A.10 <CRT Port>

Connector: **CN\_CRT2**

Type: onboard 10-pin connector for CRT connector

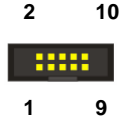

Pin	Description	Pin	Description
1	DATA	2	SL
3	G	4	R
5	GND	6	B
7	HSYNC	8	VSYNC
9	GND	10	GND

## Appendix B <Flash BIOS>

### B.1 <Flash Tool>

The board is based on Award BIOS and can be updated easily by the BIOS auto flash tool. You can download the tool online at the address below:

<http://www.phoenix.com/en/home/>  
[http://www.commell.com.tw/Support/Support\\_SBC.htm](http://www.commell.com.tw/Support/Support_SBC.htm)

File name of the tool is "awdfash.exe", it's the utility that can write the data into the BIOS flash ship and update the BIOS.

### B.2 <Flash BIOS Procedure>

1. Please make a bootable floppy disk.
2. Get the last .bin files you want to update and copy it into the disk.
3. Copy awardflash.exe to the disk.
4. Power on the system and flash the BIOS. (Example: C:/ awdfash XXX.bin)
5. Restart the system.

Any question about the BIOS re-flash please contact your distributors or visit the web-site at below:

<ftp://ftp.commell.com.tw/COMMELL/support/AWDFLASH.rar>

## Appendix C <System Resources>

### C.1 <Direct Memory Access (DMA)>



Direct memory access (DMA)



2 Standard floppy disk controller





























4 Direct memory access controller

### C.2 <Input /Output (IO)>























Input/output (IO)

	[00000000 - 0000000F]	Direct memory access controller
	[00000000 - 00000CF7]	PCI bus
	[00000010 - 0000001F]	Motherboard resources
	[00000020 - 00000021]	Programmable interrupt controller
	[00000022 - 0000003F]	Motherboard resources
	[00000040 - 00000043]	System timer
	[00000044 - 0000005F]	Motherboard resources
	[00000060 - 00000060]	Standard 101/102-Key or Microsoft Natural PS/2 Keyboard
	[00000061 - 00000061]	System speaker
	[00000062 - 00000063]	Motherboard resources
	[00000064 - 00000064]	Standard 101/102-Key or Microsoft Natural PS/2 Keyboard
	[00000065 - 0000006F]	Motherboard resources
	[00000070 - 00000073]	System CMOS/real time clock
	[00000074 - 0000007F]	Motherboard resources
	[00000080 - 00000090]	Direct memory access controller
	[00000091 - 00000093]	Motherboard resources
	[00000094 - 0000009F]	Direct memory access controller
	[000000A0 - 000000A1]	Programmable interrupt controller
	[000000A2 - 000000BF]	Motherboard resources
	[000000C0 - 000000DF]	Direct memory access controller
	[000000E0 - 000000EF]	Motherboard resources
	[000000F0 - 000000FF]	Numeric data processor
	[00000274 - 00000277]	ISAPNP Read Data Port
	[00000279 - 00000279]	ISAPNP Read Data Port

























	[000002E8 - 000002EF]	Communications Port (COM4)
	[000002F8 - 000002FF]	Communications Port (COM2)
	[00000378 - 0000037F]	Printer Port (LPT1)
	[000003B0 - 000003BB]	Mobile Intel(R) 4 Series Express Chipset Family
	[000003C0 - 000003DF]	Mobile Intel(R) 4 Series Express Chipset Family
	[000003E8 - 000003EF]	Communications Port (COM3)
	[000003F0 - 000003F5]	Standard floppy disk controller
	[000003F7 - 000003F7]	Standard floppy disk controller
	[000003F8 - 000003FF]	Communications Port (COM1)
	[00000400 - 000004BF]	Motherboard resources
	[000004D0 - 000004D1]	Motherboard resources
	[000004E8 - 000004EF]	Communications Port (COM6)
	[000004F8 - 000004FF]	Communications Port (COM5)
	[00000500 - 0000051F]	Intel(R) ICH9 Family SMBus Controller - 2930
	[00000778 - 0000077B]	Printer Port (LPT1)
	[00000880 - 0000088F]	Motherboard resources
	[00000A79 - 00000A79]	ISAPNP Read Data Port
	[00000D00 - 0000FFFF]	PCI bus
	[00007000 - 00007FFF]	Intel(R) ICH9 Family PCI Express Root Port 3 - 2944
	[00007F00 - 00007F1F]	Intel(R) 82574L Gigabit Network Connection #2
	[00008000 - 00008FFF]	Intel(R) ICH9 Family PCI Express Root Port 2 - 2942
	[00008F00 - 00008F1F]	Intel(R) 82574L Gigabit Network Connection
	[00009000 - 00009FFF]	Intel(R) ICH9 Family PCI Express Root Port 1 - 2940
	[00009F00 - 00009F1F]	Intel(R) 82574L Gigabit Network Connection #4
	[0000A000 - 0000AFFF]	Intel(R) ICH9 Family PCI Express Root Port 6 - 294A
	[0000AF00 - 0000AF1F]	Intel(R) 82574L Gigabit Network Connection #3
	[0000B000 - 0000BFFF]	Intel(R) ICH9 Family PCI Express Root Port 5 - 2948
	[0000BF00 - 0000BF1F]	Intel(R) 82574L Gigabit Network Connection #5
	[0000C000 - 0000CFFF]	Intel(R) ICH9 Family PCI Express Root Port 4 - 2946



-  [0000CF00 - 0000CF1F] Intel(R) 82574L Gigabit Network Connection #6
-  [0000EC00 - 0000EC0F] Intel(R) ICH9M/M-E 2 port Serial ATA Storage Controller 2 - 292C
-  [0000ED00 - 0000ED0F] Intel(R) ICH9M/M-E 2 port Serial ATA Storage Controller 2 - 292C
-  [0000EE00 - 0000EE03] Intel(R) ICH9M/M-E 2 port Serial ATA Storage Controller 2 - 292D
-  [0000EF00 - 0000EF07] Intel(R) ICH9M/M-E 2 port Serial ATA Storage Controller 2 - 292D
-  [0000F000 - 0000F003] Intel(R) ICH9M/M-E 2 port Serial ATA Storage Controller 2 - 292D
-  [0000F100 - 0000F107] Intel(R) ICH9M/M-E 2 port Serial ATA Storage Controller 2 - 292D
-  [0000F300 - 0000F30F] Intel(R) ICH9M/M-E 2 port Serial ATA Storage Controller 1 - 2928
-  [0000F400 - 0000F40F] Intel(R) ICH9M/M-E 2 port Serial ATA Storage Controller 1 - 2928
-  [0000F500 - 0000F503] Intel(R) ICH9M/M-E 2 port Serial ATA Storage Controller 1 - 2928
-  [0000F600 - 0000F607] Intel(R) ICH9M/M-E 2 port Serial ATA Storage Controller 1 - 2928
-  [0000F700 - 0000F703] Intel(R) ICH9M/M-E 2 port Serial ATA Storage Controller 1 - 2928
-  [0000F800 - 0000F807] Intel(R) ICH9M/M-E 2 port Serial ATA Storage Controller 1 - 2928
-  [0000F900 - 0000F91F] Intel(R) ICH9 Family USB Universal Host Controller - 2936
-  [0000FA00 - 0000FA1F] Intel(R) ICH9 Family USB Universal Host Controller - 2935
-  [0000FB00 - 0000FB1F] Intel(R) ICH9 Family USB Universal Host Controller - 2934
-  [0000FC00 - 0000FC1F] Intel(R) ICH9 Family USB Universal Host Controller - 2939
-  [0000FD00 - 0000FD1F] Intel(R) ICH9 Family USB Universal Host Controller - 2938
-  [0000FE00 - 0000FE1F] Intel(R) ICH9 Family USB Universal Host Controller - 2937
-  [0000FF00 - 0000FF07] Mobile Intel(R) 4 Series Express Chipset Family

## C.3 <Memory Address Map>

Memory		
[00000000 - 0009FFFF]	System board	
[000A0000 - 000BFFFF]	Mobile Intel(R) 4 Series Express Chipset Family	
[000A0000 - 000BFFFF]	PCI bus	
[000C0000 - 000DFFFF]	PCI bus	
[000E0000 - 000EFFFF]	System board	
[000F0000 - 000FFFFF]	System board	
[00100000 - 3BC8FFFF]	System board	
[3BC90000 - 3BCFFFFF]	System board	
[3BD00000 - 3BDFFFFF]	System board	
[3BD00000 - FEBFFFFF]	PCI bus	
[D0000000 - DFFFFFFF]	Mobile Intel(R) 4 Series Express Chipset Family	
[E0000000 - EFFFFFFF]	Motherboard resources	
[FCC00000 - FCFFFFFF]	Mobile Intel(R) 4 Series Express Chipset Family	
[FD000000 - FD0FFFFF]	Intel(R) ICH9 Family PCI Express Root Port 1 - 2940	
[FD0C0000 - FD0DFFFF]	Intel(R) 82574L Gigabit Network Connection #4	
[FD0FC000 - FD0FFFFF]	Intel(R) 82574L Gigabit Network Connection #4	
[FD400000 - FD4FFFFF]	Intel(R) ICH9 Family PCI Express Root Port 6 - 294A	
[FD500000 - FD5FFFFF]	Intel(R) ICH9 Family PCI Express Root Port 6 - 294A	
[FD5C0000 - FD5DFFFF]	Intel(R) 82574L Gigabit Network Connection #3	
[FD5FC000 - FD5FFFFF]	Intel(R) 82574L Gigabit Network Connection #3	
[FD600000 - FD6FFFFF]	Intel(R) ICH9 Family PCI Express Root Port 5 - 2948	
[FD700000 - FD7FFFFF]	Intel(R) ICH9 Family PCI Express Root Port 5 - 2948	
[FD7C0000 - FD7DFFFF]	Intel(R) 82574L Gigabit Network Connection #5	
[FD7FC000 - FD7FFFFF]	Intel(R) 82574L Gigabit Network Connection #5	
[FD800000 - FD8FFFFF]	Intel(R) ICH9 Family PCI Express Root Port 4 - 2946	
[FD900000 - FD9FFFFF]	Intel(R) ICH9 Family PCI Express Root Port 4 - 2946	
[FD9C0000 - FD9DFFFF]	Intel(R) 82574L Gigabit Network Connection #6	

- ...  [FD9FC000 - FD9FFFFFF] Intel(R) 82574L Gigabit Network Connection #6
- ...  [FDA00000 - FDAFFFFFF] Intel(R) ICH9 Family PCI Express Root Port 3 - 2944
- ...  [FDB00000 - FDBFFFFFF] Intel(R) ICH9 Family PCI Express Root Port 3 - 2944
- ...  [FDBC0000 - FDBDFFFFFF] Intel(R) 82574L Gigabit Network Connection #2
- ...  [FDBFC000 - FDBFFFFFF] Intel(R) 82574L Gigabit Network Connection #2
- ...  [FDC00000 - FDCFFFFFF] Intel(R) ICH9 Family PCI Express Root Port 2 - 2942
- ...  [FDD00000 - FDDFFFFFF] Intel(R) ICH9 Family PCI Express Root Port 2 - 2942
- ...  [FDDC0000 - FDDDFFFFFF] Intel(R) 82574L Gigabit Network Connection
- ...  [FDDFC000 - FDDFFFFFF] Intel(R) 82574L Gigabit Network Connection
- ...  [FDE00000 - FDEFFFFFF] Intel(R) ICH9 Family PCI Express Root Port 1 - 2940
- ...  [FDFF4000 - FDFF7FFF] Microsoft UAA Bus Driver for High Definition Audio
- ...  [FDFFD000 - FDFFD0FF] Intel(R) ICH9 Family SMBus Controller - 2930
- ...  [FDFFE000 - FDFFE3FF] Intel(R) ICH9 Family USB2 Enhanced Host Controller - 293A
- ...  [FDFFF000 - FDFFF3FF] Intel(R) ICH9 Family USB2 Enhanced Host Controller - 293C
- ...  [FEB00000 - FEBFFFFFF] Mobile Intel(R) 4 Series Express Chipset Family
- ...  [FEC00000 - FEC00FFF] System board
- ...  [FED00000 - FED000FF] System board
- ...  [FED00000 - FED003FF] High precision event timer
- ...  [FED13000 - FED1FFFF] System board
- ...  [FED20000 - FED9FFFF] System board
- ...  [FEE00000 - FEE00FFF] System board
- ...  [FFB00000 - FFB7FFFF] System board
- ...  [FFB80000 - FFBFFFFFF] Intel(R) 82802 Firmware Hub Device
- ...  [FFF00000 - FFFFFFFF] System board

## Appendix D <Programming GPIO's>

The GPIO's can be programmed with the MSDOS debug program using simple IN/OUT commands. The following lines show an example how to do this.

GPIO0.....GPIO7 bit0.....bit7

-o 2E 87

-o 2E 87 ;Enter configuration

-o 2E 07

-o 2F 09 ;Enable GPIO's function

-o 2E 30

-o 2F 02 ;Enable GPIO's configuration

-o 2E F0

-o 2F xx ;Set GPIO's as input/output; set '1' for input,'0' for output

-o 2E F1

-o 2F xx ;If set GPIO's as output, in this register its value can be set

Optional:

-o 2E F2

-o 2F xx ; Data inversion register; '1' inverts the current value of the bits,'0' leaves them as they are

-o 2E 30

-o 2F 01 ; Active GPIO's

For further information, please refer to Winbond W83627DHG datasheet.

## Appendix E <Programming Watchdog Timer>

The watchdog timer makes the system auto-reset while it stops to work for a period.

The integrated watchdog timer can be setup as system reset mode by program.

### Time-out Value Range

- 1 to 255
- Second or Minute

### Program Sample

Watchdog timer setup as system reset with 5 second of timeout

---

2E, 87	
2E, 87	
2E, 07	
2F, 08	Logical Device 8
2E, 30	
2F, 01	Activate
2E, F5	
2F, 00	Set as Second*
2E, F6	
2F, 05	Set as 5

---

\* Minute: bit 3 = 1; Second: bit 3 = 0

You can select Timer setting in the BIOS, after setting the time options, the system will reset according to the period of your selection.

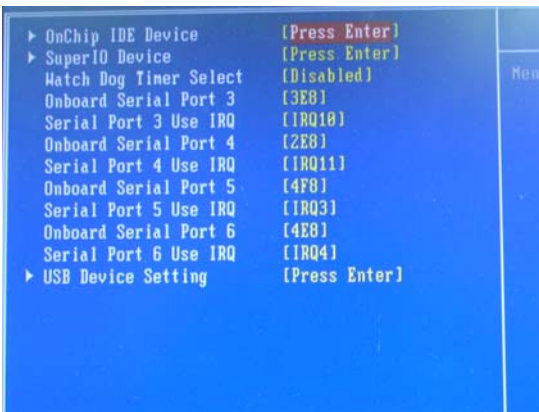

## Contact Information

Any advice or comment about our products and service, or anything we can help you please don't hesitate to contact with us. We will do our best to support you for your products, project a business.

### Taiwan Commate Computer Inc.

Address	19F., No.94, Sec. 1, Xintai 5th Rd., Xizhi Dist., New Taipei City 22102, Taiwan
TEL	+886-2-26963909
FAX	+886-2-26963911
Website	<a href="http://www.commell.com.tw">http://www.commell.com.tw</a>
E-Mail	<a href="mailto:info@commell.com.tw">info@commell.com.tw</a> (General Information) <a href="mailto:tech@commell.com.tw">tech@commell.com.tw</a> (Technical Support)
Facebook	<a href="https://www.facebook.com/pages/Taiwan-Commate-Computer-Inc/547993955271899">https://www.facebook.com/pages/Taiwan-Commate-Computer-Inc/547993955271899</a>
Twitter	<a href="https://twitter.com/Taiwan_Commamate">https://twitter.com/Taiwan_Commamate</a>

**Commell is a brand name of Taiwan Commate Computer Inc.**