

LS-579

5.25" Desktop Miniboard

User's Manual

Edition 2.0

2022/03/24

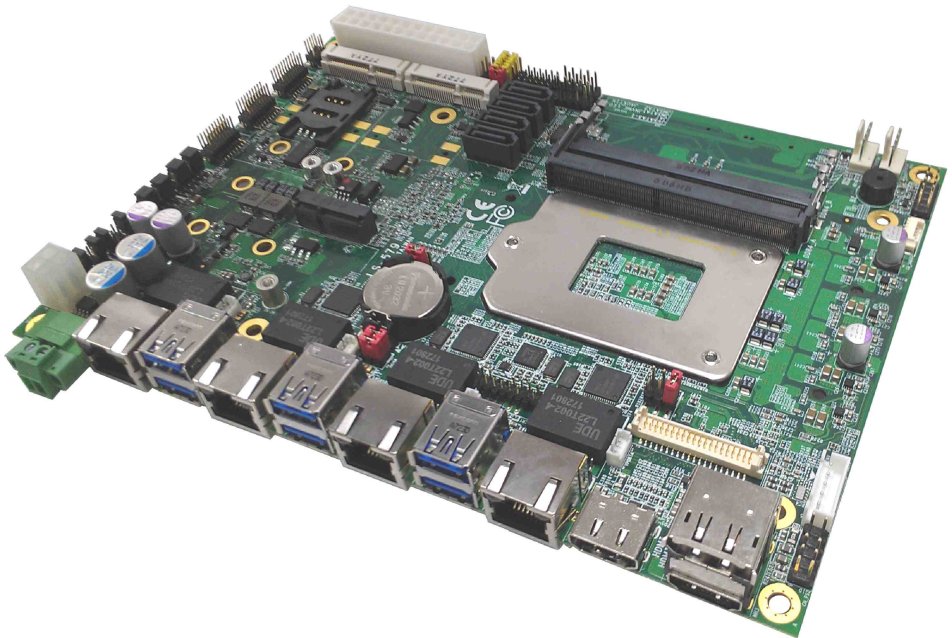

Copyright

Copyright 2021, all rights reserved. This document is copyrighted and all rights are reserved. The information in this document is subject to change without prior notice to make improvements to the products.

This document contains proprietary information and protected by copyright. No part of this document may be reproduced, copied, or translated in any form or any means without prior written permission of the manufacturer.

All trademarks and/or registered trademarks contains in this document are property of their respective owners.

Disclaimer

The company shall not be liable for any incidental or consequential damages resulting from the performance or use of this product.

The company does not issue a warranty of any kind, express or implied, including without limitation implied warranties of merchantability or fitness for a particular purpose.

The company has the right to revise the manual or include changes in the specifications of the product described within it at any time without notice and without obligation to notify any person of such revision or changes.

Trademark

All trademarks are the property of their respective holders.

Any questions please visit our website at <http://www.commell.com.tw>

Packing List:

Please check the package content before you starting using the board.



1 x LS-579 5.25" Desktop Miniboard



**1 x Cooler Fan
(OHSF-579 / 2181010030)**

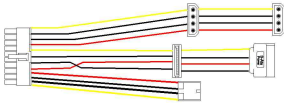

**1 x Power Cable
(OALATX-P3S2 / 1040058)**



**2 x SATA Cable
(OALSATA3-L / 1040529)**



**1 x VGA Cable
(OALVGA-SNB-7) / (1040557)**



**1 x Dual COM cable
(OALES-BKU2NB / 1040090)**

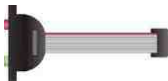

**1 x Audio cable
(OALPJ-HDUNB / 1040123)**

Optional:

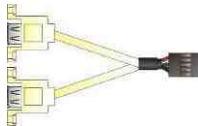

**1 x USB2.0 cable
(OALUSBA-3) / (1040173)**



**1 x PS/2 Keyboard & Mouse cable
(OALPS2/KM / 1040131)**

Printed Matters:

Driver CD (Including User's Manual) x 1

Index

Chapter 1 <Introduction>	4
1.1 <Product Overview>	4
1.2 <Product Specification>	5
1.3 <Block Diagram>	6
Chapter 2 <Hardware setup>	7
2.1 <Connector Location and Reference>	7
2.1.1 <Internal connectors list>	8
2.1.2 <External connectors list>	8
2.2 <CPU and Memory installation guide>	9
2.2.1 <CPU compatible list>	9
2.2.2 <CPU installation>	10
2.2.3 <Cooler Fan installation>	11
2.2.4 <Memory Setup>	13
2.3 <Jumper Location and Reference>	14
2.3.1 <Jumper list>	14
2.3.2 <Clear CMOS and Power on type selection>	15
2.4 <I/O interface>	15
2.4.1 <Serial ATA interface>	15
2.4.2 <Ethernet interface>	16
2.4.3 < Power Sourcing Equipment >	16
2.4.4 <Display interface>	17
2.4.5 <Serial Port interface>	19
2.4.6 <USB interface>	22
2.4.7 <Audio interface>	23
2.4.8 <Expansion slot>	24
2.4.8.1 < M.2 interface >	25
2.4.8.2 < MINI_CARD Setting >	26
2.4.8.3 < SIMM Setup>	26
2.4.9 <Front panel switch and indicator>	27
2.4.10 <GPIO and Other interface>	27
2.5 <Power supply>	30
2.5.1 <Power input>	30
Appendix A <Flash BIOS>	32
Appendix B <LCD Panel Type select>	32
Appendix C <Programmable Watch Dog Timer>	34
Appendix D <Hardware monitor >	35
Appendix E <Programmable GPIO >	36
Appendix F <RAID Setting>	37
Appendix G < Setup ADP-3355,ADP-3460 >	39
Appendix H < Setup PoE device >	39
Contact information	41

Chapter 1 <Introduction>

1.1 <Product Overview>

LS-579 is 5.25" Desktop Miniboard which supports 6th & 7th Generation Intel® Core™ i7/ i5/ i3, S-series and Xeon® Processor with Intel® C236 Chipset, integrated HD Graphics , DDR4 memory, Realtek High Definition Audio, Intel Gigabit LAN, Serial ATA3

Intel Skylake-S & Kaby Lake-S Processor with Intel® C236 Chipset

The 6th & 7th Intel® Core™ S-series and Xeon® processor family is new generation and multi-core processor built on 14 nanometer process.

It provide new HD Graphics support triple displays at the same time, maximum supported is up to 32GB of DDR4, better performance, flexibility and more enhanced security that is suitable for a variety of intelligent systems the ideal choice.

Flexible Expansion Interface

It includes 2 x MiniPCIe slot, SIM, 2 x M.2 (Key M), M.2 (KeyE)

Skylake & Kaby Lake remove EHCI, all USB ports are xHCI

When you install Windows7 with USB device(CDROM, Keyboard, Mouse...), Windows7 can not identify your usb device. You can use SATA CD-ROM and PS/2 to install Windows7.

**PS/2 cable is optional.*

Kaby Lake(7th gen CPU) only support Windows10 64bit

Intel only support Windows 10 64bit. It may lose some drivers if you use other Windows version.

1.2 <Product Specification>

System

Processor	Intel® 6th & 7th Core™ i7/ i5/ i3 and Xeon® E3-1200 v5/ v6 Processor, FCLGA1151 package (TDP up to 45W)
Chipset	Intel® C236 PCH
Memory	2 x DDR4 DIMM 1866/2133 MHz up to 32GB, Support Non-ECC, unbuffered memory only (Xeon® E3-1200 v5 / v6 Product support ECC memory)
Watchdog Timer	Generates a system reset with internal timer for 1min/s ~ 255min/s
Real Time Clock	Chipset integrated RTC with onboard lithium battery
Expansion	2 x M.2 (Key M) for NVMe 2242/2260/2280mm 1 x M.2 (Key E) for Wi-Fi and Bluetooth 2230mm 2 x MiniPCIe (support mSATA) 1 x Sim slot

Graphics

Processor	Intel® 9th Gen integrated HD Graphics (Some Xeon® E3-1200 v5/ v6 Product CPU not support)
Display Interface	1 x DisplayPort, 2 x HDMI, 1 x VGA, 1 x LVDS

LAN

Chip	1 x Intel® I219-LM Gigabit PHY LAN 3 x Intel® I210-AT Gigabit LAN
------	----------------------------------------------------------------------

I/O

Serial ATA	4 x SATA3 interface with 600MB/s transfer rate
Audio	Realtek ALC262 HD Audio
Internal I/O	4 x SATA3, 2 x RS232/422/485, 4 x RS232, 4 x USB2.0, 1 x LPC, 1 x GPIO, 1 x PS/2, 1 x SMBUS, 1 x Audio, 1 x LVDS, 1 x LCD inverter, 1 x VGA
Rear I/O	6 x USB3.0, 4 x LAN 2 x HDMI, 1 x Display Port,

Mechanical & Environmental

Power Requirement	Standard 24-pin ATX power supply or 4-pin DC 9~35V
Size & Thickness	203mm x 146mm (L x W)
Temperature	Operating within 0°C~60°C (32°F~140°F) Storage within -20°C~80°C (-4°F~176°F)
Relative Humidity	10%~90%, non-condensing

1.3 <Block Diagram>

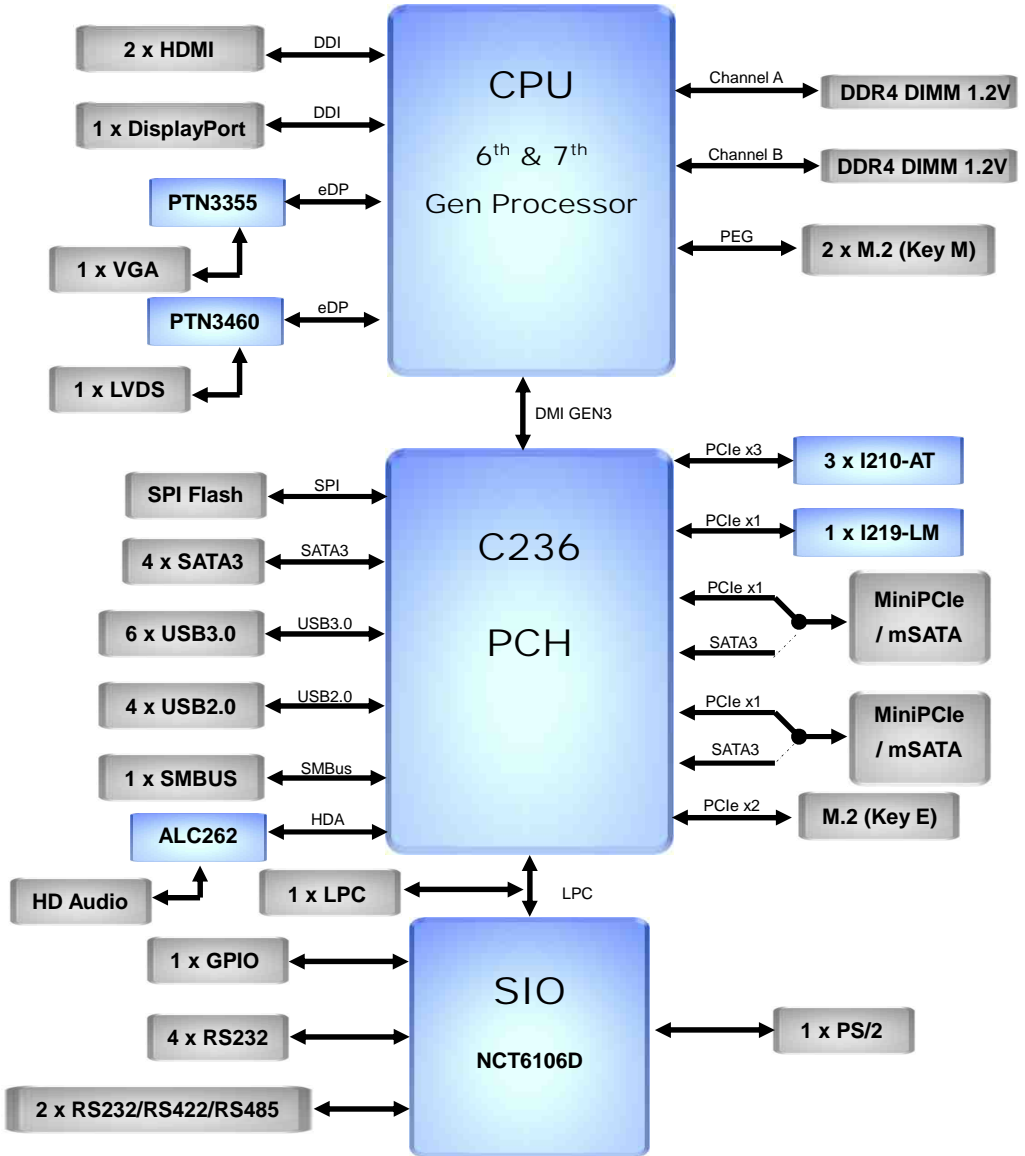

Chapter 2 <Hardware setup>

2.1 <Connector Location and Reference>

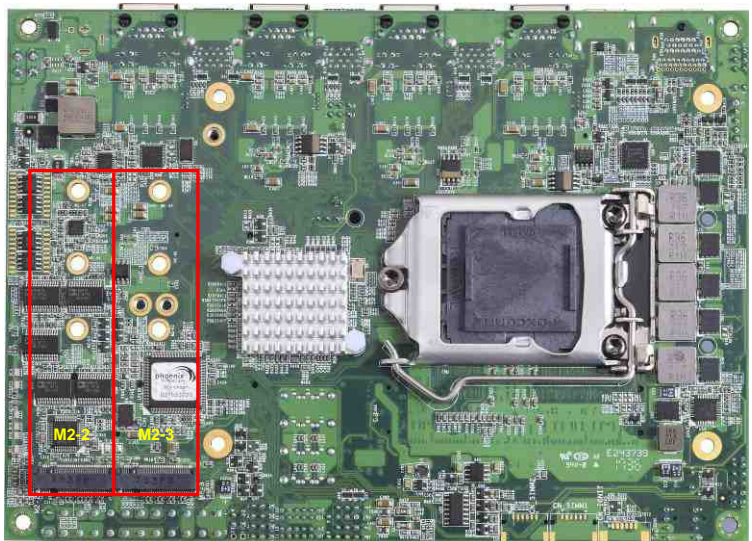
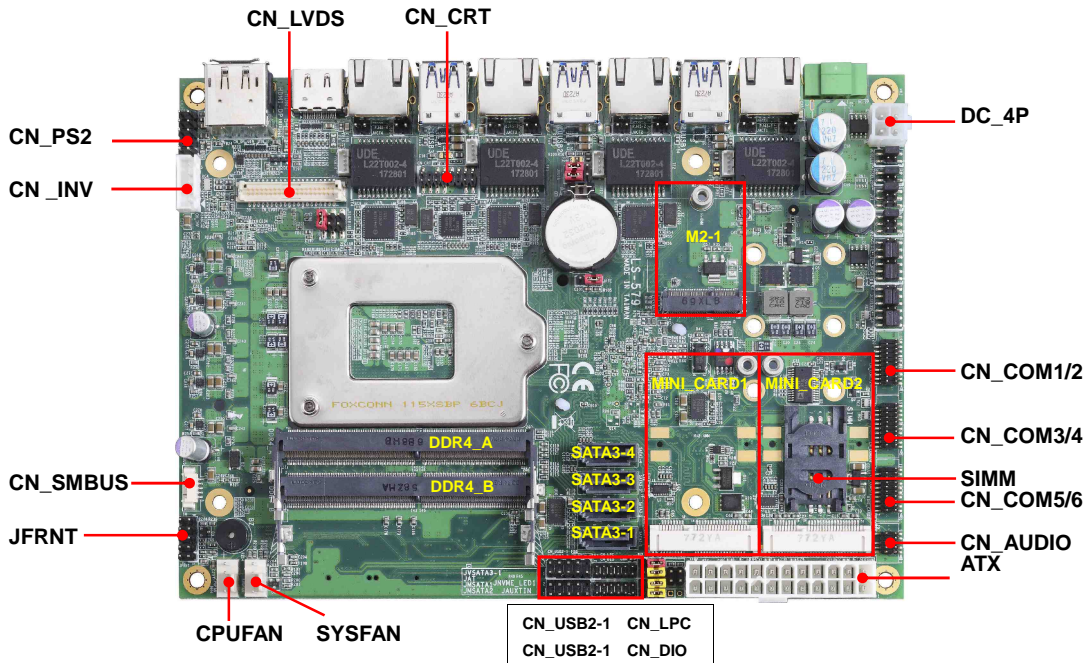

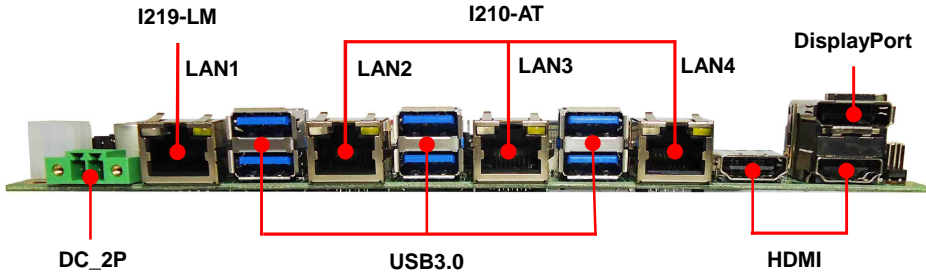

2.1.1 <Internal connectors list>

Connector	Function
DDR4_A/B	260-pin DDR4 SO-DIMM slot
SATA3-1/2/3/4	7-pin Serial ATA3 connector
CN_AUDIO	5 x 2-pin audio pin header
CN_LPC	6 x 2-pin LPC pin header
CN_LVDS	20 x 2-pin LVDS connector
CN_INV	5-pin LCD inverter connector
CN_SMBUS	5-pin SMBus connector
CN_COM1/2, 3/4/, 5/6	20-pin RS232 connector
CN_USB 2-1/2-2	5 x 2-pin USB2.0 pin header
CN_PS2	5 x 2-pin PS/2 pin header
CN_DIO	6 x 2-pin digital I/O connector
CN_CRT	16-pin VGA connector
CPUFAN	4-pin CPU fan connector
SYSFAN	4-pin system fan connector
JFRNT	14-pin front panel switch/indicator connector
MINI_CARD1	52-pin Half-MiniPCIe card slot
MINI_CARD2	52-pin MiniPCIe card slot
M2-1	75-pin M.2 Key E slot
M2-2/3	75-pin M.2 Key M slot
ATX	24-pin power supply connector
DC_4P	4-pin power input Terminal Block
SIMM	6-pin socket

2.1.2 <External connectors list>

Connector	Function
DisplayPort	DisplayPort connector
HDMI	HDMI connector
USB3.0	USB3.0 connector
LAN	RJ45 connector
DC_2P	2-pin power input Terminal Block

2.2 <CPU and Memory installation guide>

2.2.1 <CPU compatible list>

Recommended TDP less than 45W, please refer to the following models

Skylake-S and Kaby Lake-S compatible list					
Skylake	Core	TDP	Kaby Lake	Core	TDP
E3-1268L v5 _(Note1)	4	35W	i7-7700T	4	35W
E3-1260L v5 _(Note2)	4	45W	i5-7600T	4	35W
E3-1240L v5 _(Note2)	4	25W	i5-7500T	4	35W
E3-1235L v5	4	25W	i5-7400T	4	35W
i7-6700TE _(Note1)	4	35W	i3-7300T	2	35W
i7-6700T	4	35W	i3-7101TE _(Note1)	2	35W
i5-6600T	4	35W	i3-7100T	2	35W
i5-6500TE _(Note1)	4	35W	G4600T	2	35W
i5-6500T	4	35W	G4560T	2	35W
i5-6400T	4	35W	G3930TE _(Note1)	2	35W
i3-6300TE _(Note1)	2	35W	G3930T	2	35W
i3-6300T	2	35W	G3900TE _(Note1)	2	35W
i3-6100TE _(Note1)	2	35W	G4400TE _(Note1)	2	35W
i3-6100T	2	35W			
G4500T	2	35W			
G4400T	2	35W			

Note1: Embedded processors with long-term support

Note2: No Graphics Output.

2.2.2 <CPU installation>

LS-579 has a LGA1151 CPU socket onboard; please check following steps to install the processor properly.

Attention If LS-579 needs RMA, please **Keep CPU socket cover on the CPU Socket.**

Warning If CPU Socket internal Pin damage, We could not provide warranty.



Intel® 6th & 7th Core™ i7/ i5/ i3 and Xeon® E3-1200
v5/ v6 Processor, FCLGA1151 package

1. Lift this bar



2. Uncover this plate



Checked point

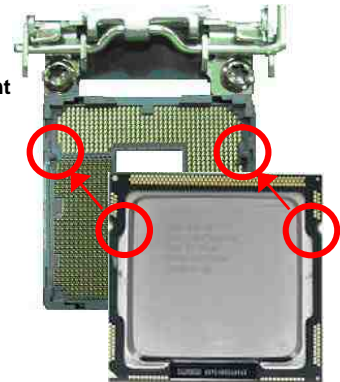

3. Place the CPU on the top of the pins

4. Cover this plate

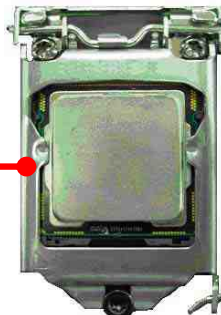

5. Lock this bar

2.2.3 <Cooler Fan installation>

Step1. Apply Thermal Paste on the CPU.

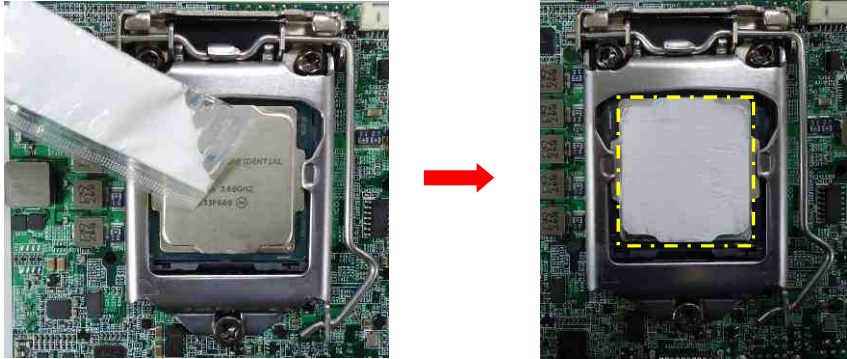

Step2. Check screw package.

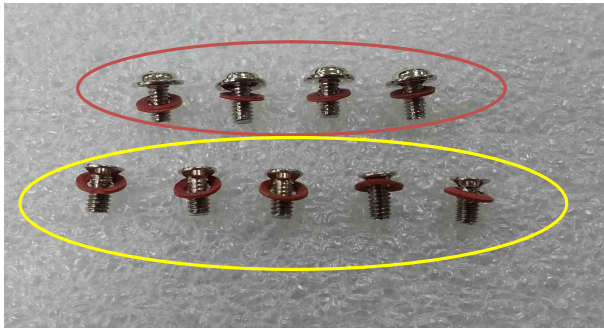

- a. M3x5L4 pcs
- b. M2.5x6L5 pcs

Step3. Mount the Heatsink after aligning.

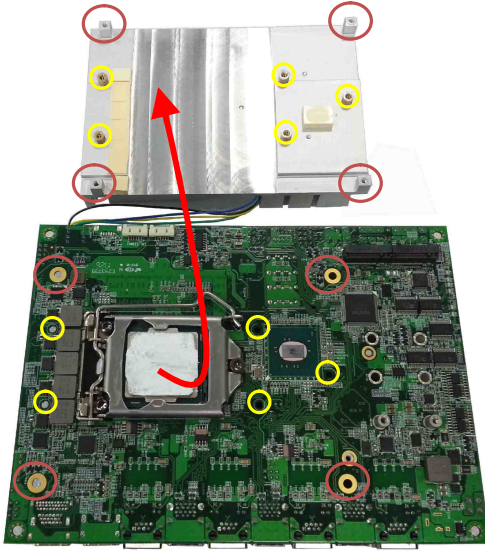

Step4. Screw on the Heatsink and install Fan, finish.

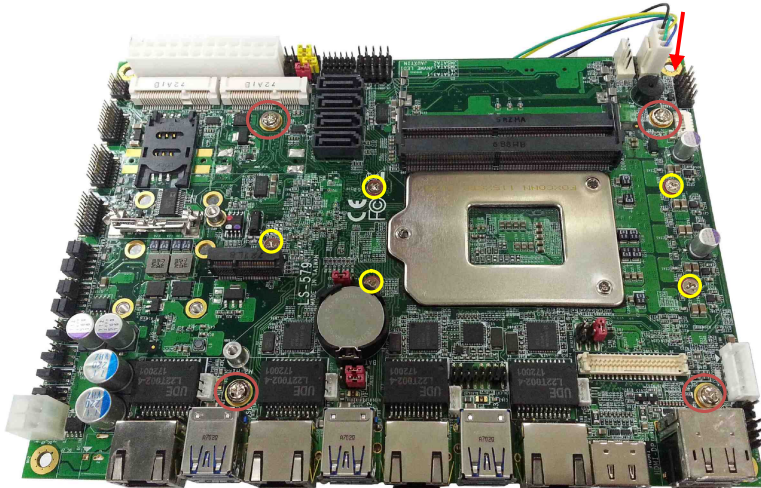

2.2.4 <Memory Setup>

LS-579 has two 260-pin DDR4 SO-DIMM support up to 32GB of memory capacity and 1.2 Voltage. The memory frequency supports 1866/2133 MHz. Only Non-ECC memory is supported. (Xeon® E3-1200 v5 / v6 Product support ECC memory)

In the process, the board must be powered off.

1. Put the memory tilt into the slot. Note the Memory notch key aligned slot key.
2. Then press down till lock into the mounting notch.

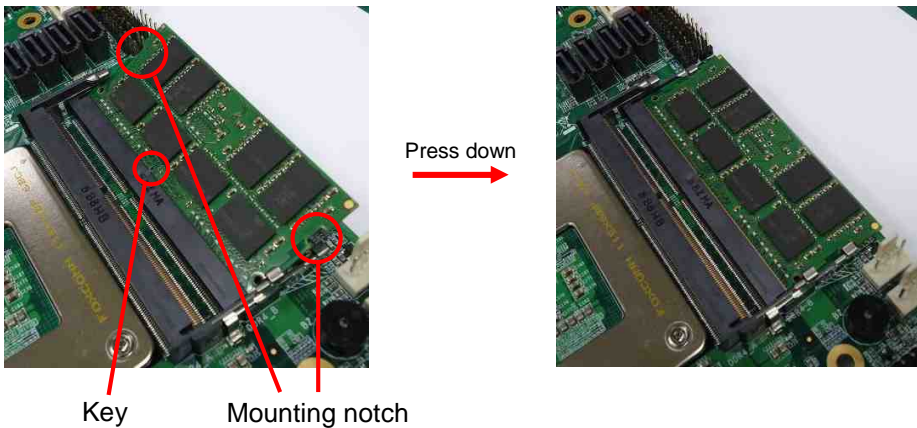

3. To remove the memory, push outward on both sides of the latch.

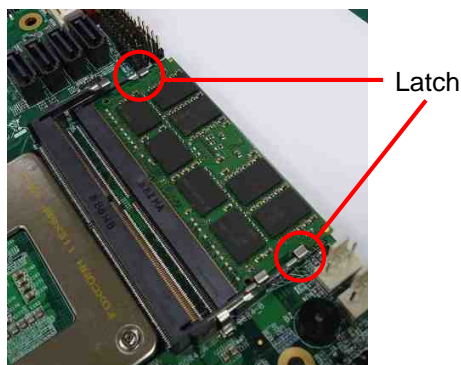

2.3 <Jumper Location and Reference>

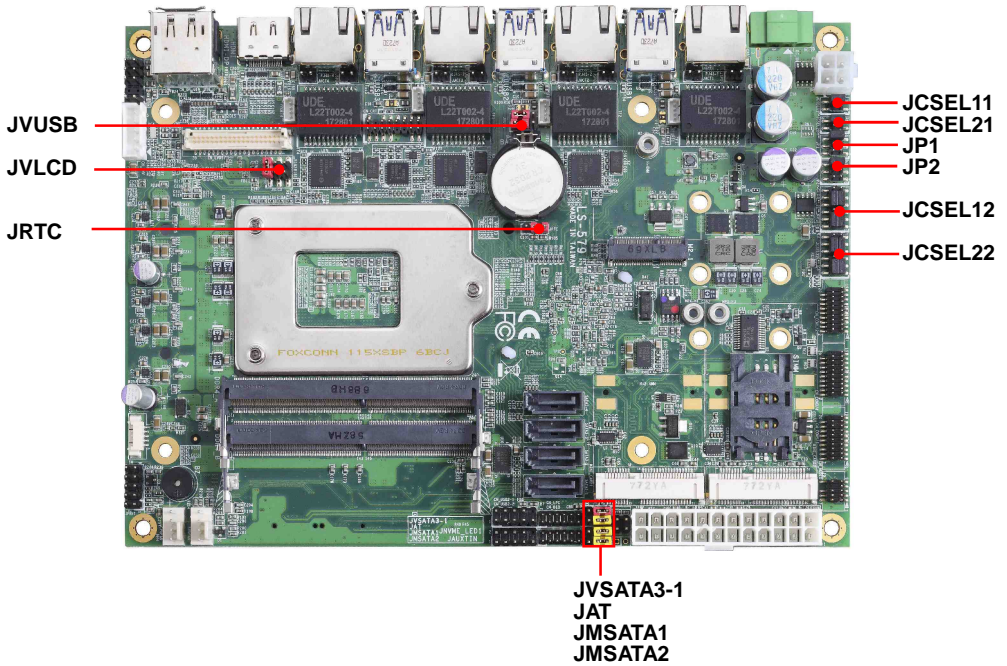

2.3.1 <Jumper list>

Jumper	Function
JAT	Power mode select
JRTC	CMOS Normal/Clear Setting
JVLCD	Panel Voltage Setting
JMSATA1	MiniCard 1 MSATA Setting
JMSATA2	MiniCard 2 MSATA Setting
JP1	COM1 Voltage Setting (For Pin 9)
JP2	COM2 Voltage Setting (For Pin 9)
JCSEL11	COM1 RS-232 RS422 RS485 Setting
JCSEL21	COM2 RS-232 RS422 RS485 Setting
JCSEL12	COM1 RS-232 RS422 RS485 Setting
JCSEL22	COM2 RS-232 RS422 RS485 Setting
JVSATA3-1	Set 5V to SATA3-1 pin 7 (For SATADOM)
JVUSB	USB Voltage Setting

2.3.2 <Clear CMOS and Power on type selection>

The board's data of CMOS can be setting in BIOS. If the board refuses to boot due to inappropriate CMOS settings, here is how to proceed to clear (reset) the CMOS to its default values.

JAT: AT/ATX mode select jumper

Jumper settings	Function
1-2	AT mode
2-3	ATX mode (Default)



JRTC: Clear CMOS data jumper

Jumper settings	Function
1-2	Clear CMOS
2-3	Normal (Default)



2.4 <I/O interface>

2.4.1 <Serial ATA interface>

SATA3-1/2/3/4: SATA3 7-pin connector

Pin	Signal
1	GND
2	TX+
3	TX-
4	GND
5	RX-
6	RX+
7	GND

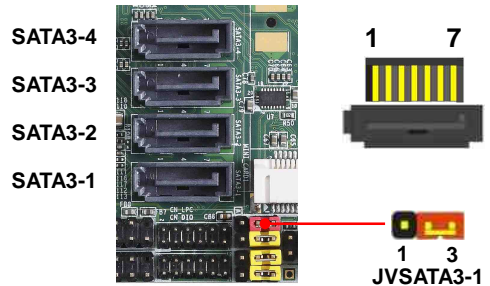

JVSATA3-1: SATA3/SATADOM mode select jumper (change pin7 to 5V)

Jumper settings	Function
1-2	SATA3-2 SATADOM
2-3	SATA3-2 SATA3 (Default)

2.4.2 <Ethernet interface>

The board provide I219-LM PHY Gigabit Ethernet and I210-AT Gigabit Ethernet on rear I/O. Intel I219-LM and I210 supports operation at 10/100/1000 Mb/s data rates, with IEEE802.3 compliance and Wake-On-LAN supported.

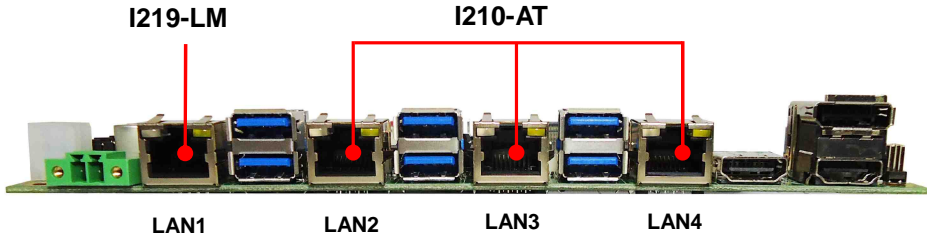

2.4.3 < Power Sourcing Equipment >

With ADP-PSE4 support four independent PSE function capable of delivering up to 90W.

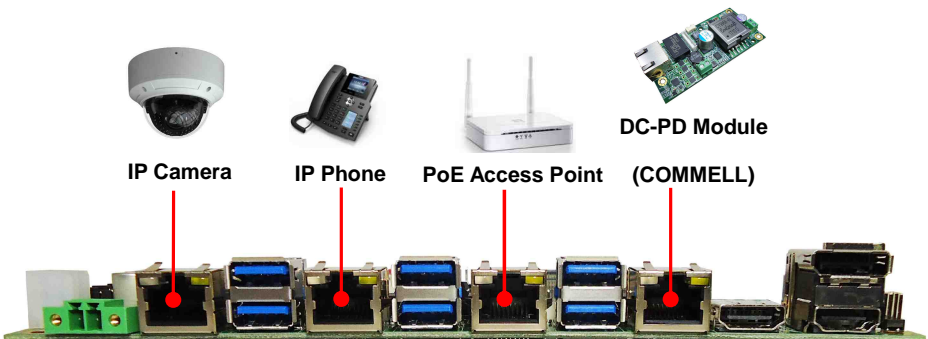

2.4.4 <Display interface>

Based on the 6th & 7th Gen CPU with built-in HD Graphics 530, VGA up to 1920x1080@60Hz, DisplayPort up to 4096x2304@60Hz, HDMI up to 4096x2304@24Hz on rear IO. About the internal Display, LVDS (PTN3460) up to 1920x1200@60Hz support 18/24-bit color depth and single/dual channel. About select LCD Panel Type in BIOS, please refer **Appendix B**.

The built-in HD Graphics support triple display function with clone mode and extended mode.

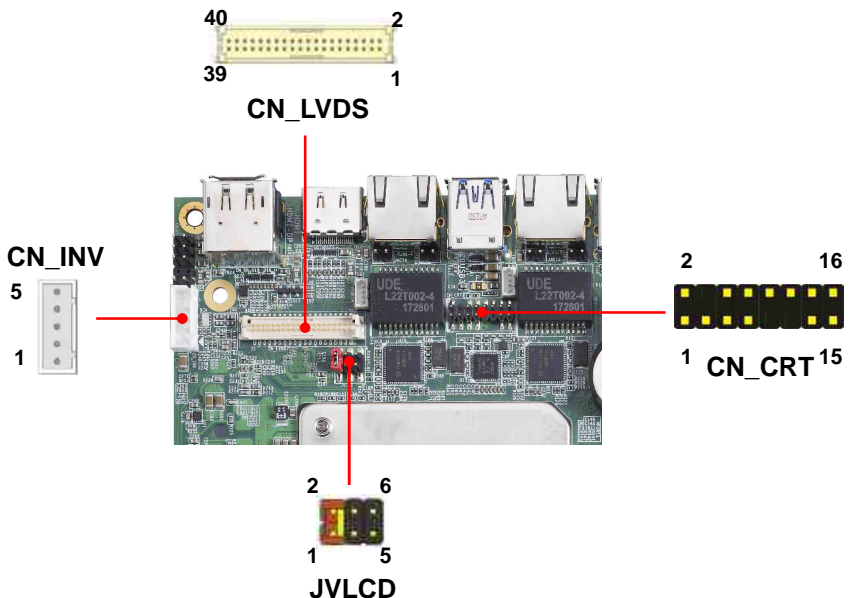
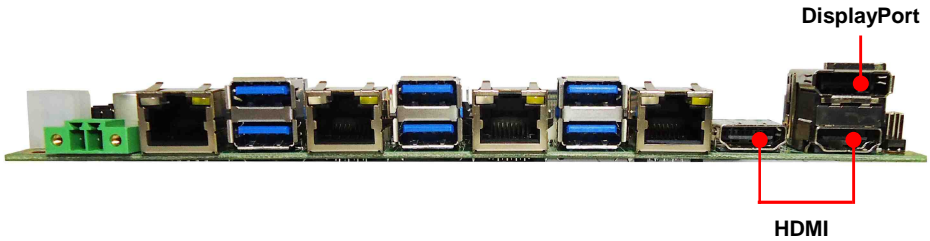

CN_CRT: VGA 16-pin connector (Pitch 2.00 mm)

Pin	Signal	Pin	Signal
1	BR	2	BG
3	BB	4	NC
5	IOGND1	6	IOGND1
7	IOGND1	8	IOGND1
9	NC	10	IOGND1
11	NC	12	5VCDA
13	5HSYNC	14	5VSYNC
15	5VCLK	16	NC

CN_LVDS: LVDS 40-pin connector (Model: HIROSE DF13-40DP-1.25V compatible)

Pin	Signal	Pin	Signal
2	Set by JVLCD	1	Set by JVLCD
4	Detect (Active low)	3	GND
6	A_LVDS_0-	5	B_LVDS_0-
8	A_LVDS_0+	7	B_LVDS_0+
10	GND	9	GND
12	A_LVDS_1-	11	B_LVDS_1-
14	A_LVDS_1+	13	B_LVDS_1+
16	GND	15	GND
18	A_LVDS_2-	17	B_LVDS_2-
20	A_LVDS_2+	19	B_LVDS_2+
22	GND	21	GND
24	A_LVDS_CLK-	23	B_LVDS_3-
26	A_LVDS_CLK+	25	B_LVDS_3+
28	GND	27	GND
30	A_LVDS_3-	29	B_LVDS_CLK-
32	A_LVDS_3+	31	B_LVDS_CLK+
34	GND	33	GND
36	LVDS_DDCSCL	35	NC
38	LVDS_DDCSDA	37	NC
40	NC	39	NC

Pin4 only need to be connected to GND

CN_INV: LVDS 5-pin Backlight power connector

Pin	Signal
1	12V
2	Backlight Control
3	GND
4	GND
5	Enable Backlight

JVLCD: LVDS panel power select jumper

Jumper settings	Function
1-2	3.3V (Default)
3-4	5V
5-6	12V

2.4.5 <Serial Port interface>

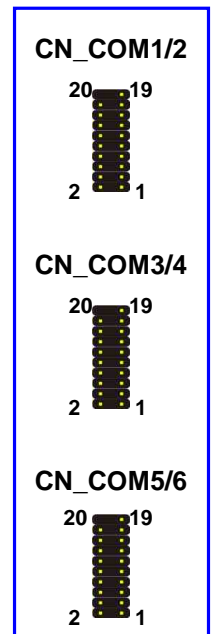
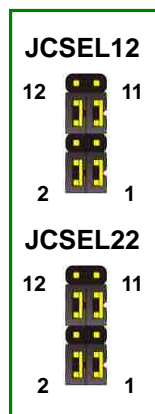
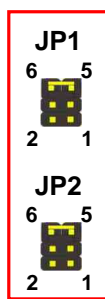
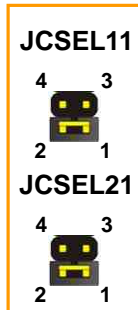
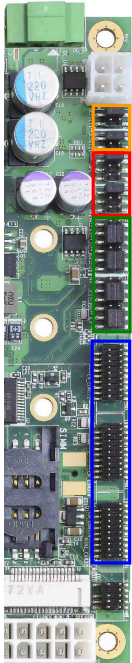

COM1/2: RS232/422/485 20-pin header (Pitch 1.27mm x 2.54mm)

Pin	Signal	Pin	Signal
1	DCD/ 422TX-/ 485-	2	RXD/ 422TX+/ 485+
3	TXD/ 422RX+	4	DTR/ 422RX-
5	GND	6	DSR
7	RTS	8	CTS
9	Set by JP2	10	N/C
11	DCD/ 422TX-/ 485-	12	RXD/ 422TX+/ 485+
13	TXD/ 422RX+	14	DTR/ 422RX-
15	GND	16	DSR
17	RTS	18	CTS
19	Set by JP1	20	N/C

Note: COM1 Use JCSEL12 select communication mode.

COM2 Use JCSEL22 select communication mode.

COM3/4: COM 20-pin header (Pitch 2.54 x 1.27mm)

Pin	Signal	Pin	Signal
1	DCD1	2	RXD1
3	TXD1	4	DTR1
5	GND	6	DSR1
7	RTS1	8	CTS1
9	RI1	10	NC
11	DCD2	12	RXD2
13	TXD2	14	DTR2
15	GND	16	DSR2
17	RTS2	18	CTS2
19	RI2	20	Key

COM5/6: COM 20-pin header (Pitch 2.54 x 1.27mm)

Pin	Signal	Pin	Signal
1	DCD1	2	RXD1
3	TXD1	4	DTR1
5	GND	6	DSR1
7	RTS1	8	CTS1
9	RI1	10	NC
11	DCD2	12	RXD2
13	TXD2	14	DTR2
15	GND	16	DSR2
17	RTS2	18	CTS2
19	RI2	20	Key







JP1, JP2: COM1, COM2 pin-9 setting

Jumper settings	Function
1-2	5V
3-4	12V
5-6	RI (Default)

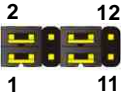
Effective patterns of connection: 1-2 / 3-4 / 5-6

Other may cause damage

JCSEL12/22, JCSEL11/21: For configure COM1 & COM2 communication mode

Function	JCSEL12/ JCSEL22	JCSEL11/ JCSEL21
RS232 (Default)		
RS485		
RS422		

RS-485

Com1 RTX-Data- : short Pin1& Pin4

Com1 RTX+ Data+ : short Pin2& Pin3

Com2 RTX- Data- : short Pin1& Pin4

Com2 RTX+ Data+ : short Pin2& Pin3

Note:

The RS-422/485 can optionally isolate transceiver, default wasn't supported isolate.

2.4.6 <USB interface>

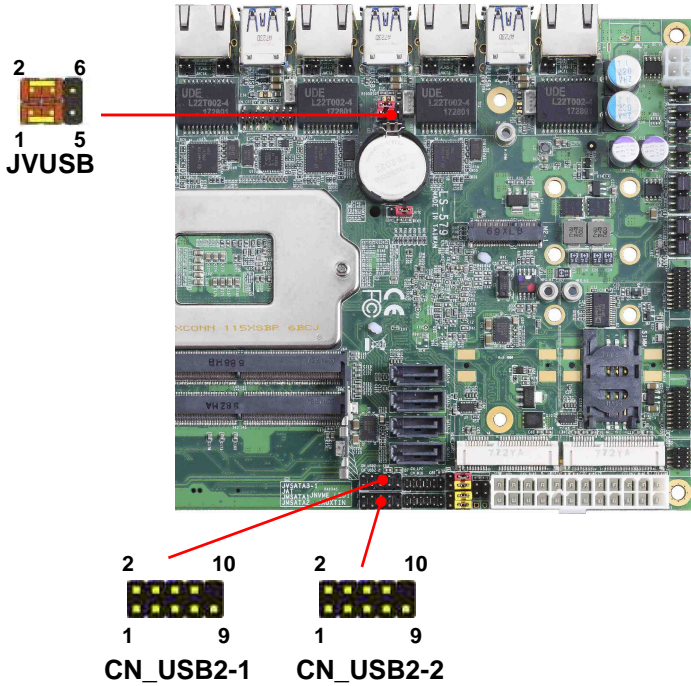
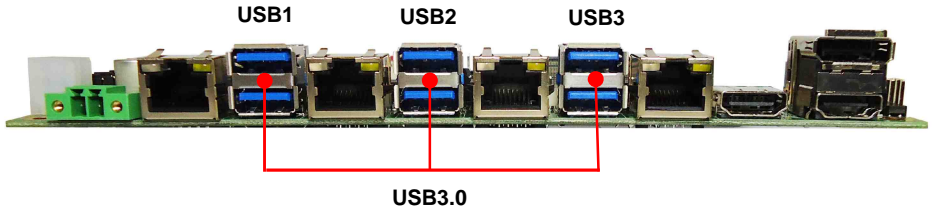

CN_USB 2-1/2-2: USB2.0 10-pin header (Pitch 2.54 mm)

Pin	Signal	Pin	Signal
1	5VSB	2	5VSB
3	DATA0-	4	DATA1-
5	DATA0+	6	DATA1+
7	GND	8	GND
9	GND	10	Key

Install USB3.0 Driver if you want to use CN_USB 2-1/2-2 in Windows7.

JVUSB: 6-pin Power select jumper

Pin	Description
1-3 & 2-4	5V_SB (Default)
3-5 & 4-6	5V

Effective patterns of connection: 1-3 & 2-4 or 3-5 & 4-6

JVUSB can control USB2(UP) and USB2(Down) power

USB1 & USB3 have 5V_SB

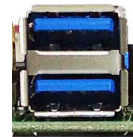

Up
Down

USB2

2.4.7 <Audio interface>

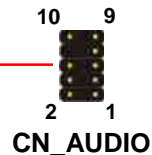
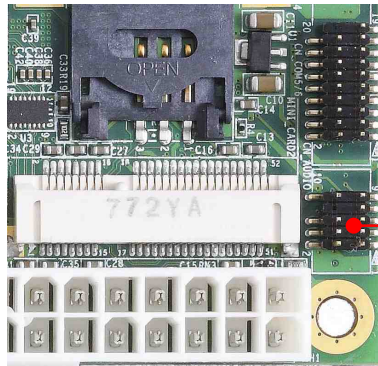

CN_AUDIO: Front panel audio 10-pin header (Pitch 2.54mm)

Pin	Signal	Pin	Signal
1	MIC_L	2	GND
3	MIC_R	4	NC
5	FP_OUT_R	6	MIC_DETECT
7	SENSE	8	Key
9	FP_OUT_L	10	FP_OUT_DETECT

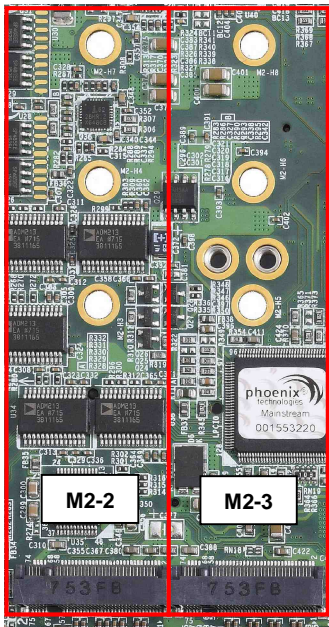
2.4.8 <Expansion slot>

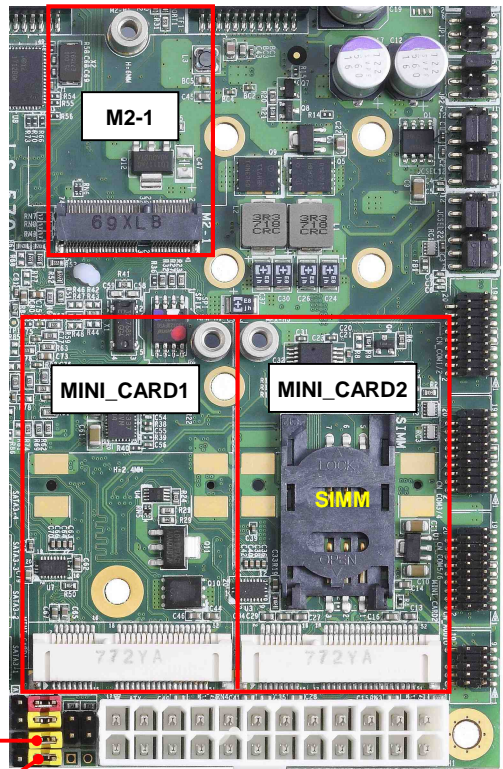
JMSATA1

JMSATA2

2.4.8.1 < M.2 interface >

M2-1 (Key E) with 2x PCI Express x1 support WI-FI and Bluetooth Module

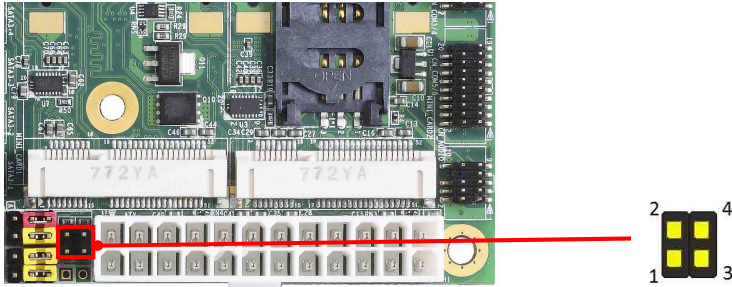
M2-2 and M2-3 (Key M) with 4x PCI Express x1 3.0 / 2.0 bandwidth, up to 32Gbit / s data transfer speed, support NVMe SSD.



Pin	Signal	Pin	Signal
1	NVMELED1-	2	NVMELED1+
3	NVMELED2-	4	NVMELED2+

NVMELED1ú M2-2

NVMELED2ú M2-3

2.4.8.2 < MINI_CARD Setting >

MINI_CARD1 and MINI_CARD2 have some special design to compatible our Mini-PCle card. (ex: MPX-574D2, MPX-210D2 etc)

MINI_CARD1 support mSATA by JMSATA1

MINI_CARD2 support mSATA by JMSATA2, and connect SIM card with 3G module.

JMSATA1/2: Setting MINI_CARD to support PCIe/mSATA

Jumper settings	Function
1-2	Support mSATA
2-3	Normal operation (Default)

2.4.8.3 < SIMM Setup>

This is for 3G miniPCle card which doesn't have SIM slot.

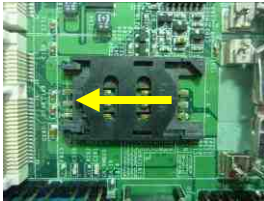

Slide the direction of the arrow open the cover.



Then press down and slide the direction of the arrow close the cover.

Insert the SIM card and make sure the direction is correct

2.4.9 <Front panel switch and indicator>

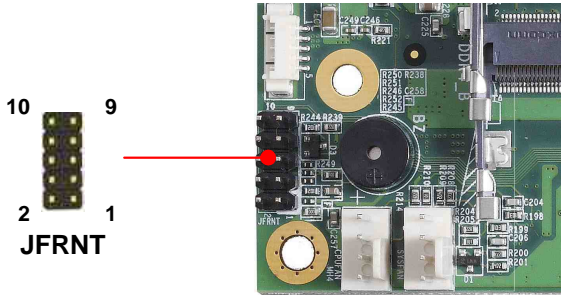

JFRNT: Front panel switch and indicator 14-pin header (Pitch 2.54mm)

Pin	Signal	Pin	Signal
1	Power_ON-	2	Power_ON+
3	Speaker-	4	Speaker+
5	HDD_LED-	6	HDD_LED+
7	Power_LED-	8	Power_LED+
9	Reset+	10	Reset-

2.4.10 <GPIO and Other interface>

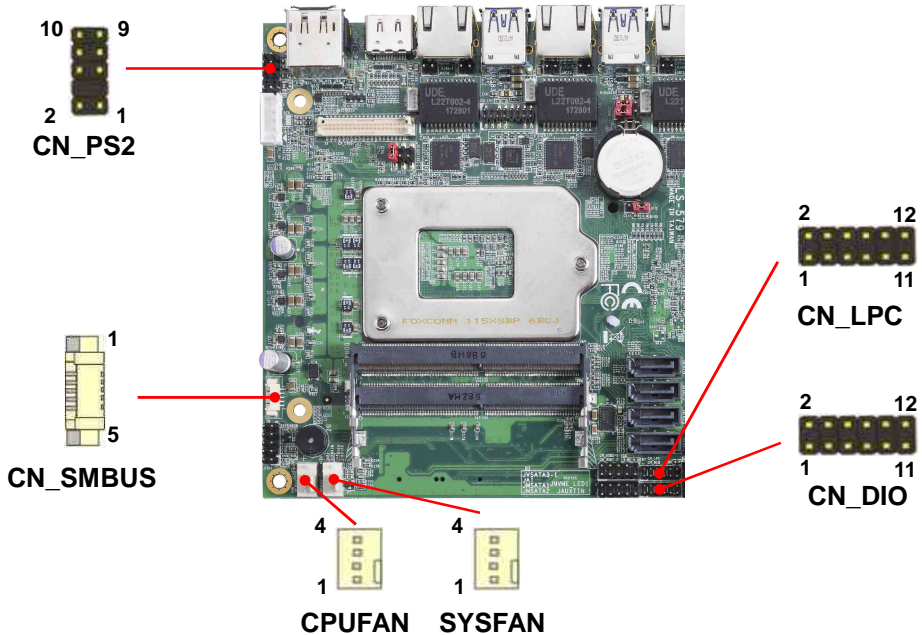

When using GPIO function, please note:

As Output: **Open-drain**, most applications **need use an external pull up resistor. (If not may cause damage)**

As Input: **TTL-level**.

GPIO DC characteristics

Parameter	SYM	MIN	TYP	MAX	UNIT	Conditions
Input Low Voltage	V_{IL}			0.8	V	
Input High Voltage	V_{IH}	2.0			V	
Output Low Voltage	V_{OL}			0.4	V	$I_{OL} = 12\text{mA}$
Input High Leakage	I_{LH}			+10	μA	$V_{IN} = 3.3\text{V}$
Input Low Leakage	I_{LL}			-10	μA	$V_{IN} = 0\text{V}$

CN_DIO: GPIO 12-pin header (Pitch 2.00mm)

Pin	Signal	Pin	Signal
1	GND	2	GND
3	GPIO0	4	GPIO4
5	GPIO1	6	GPIO5
7	GPIO2	8	GPIO6
9	GPIO3	10	GPIO7
11	5V	12	12V

CN_LPC: LPC 12-pin header (Pitch 2.00mm)

Pin	Signal	Pin	Signal
1	CLK	2	RST
3	-LFRAME	4	LAD3
5	LAD2	6	LAD1
7	LAD0	8	3.3V
9	SERIRQ	10	GND
11	3.3VSB	12	NC

CN_PS/2: PS/2 10-pin header (Pitch 2.54mm)

Pin	Signal	Pin	Signal
1	KB_DATA	2	M_DATA
3	NC	4	NC
5	GND	6	GND
7	VCC	8	VCC
9	KB_CLK	10	M_CLK

CN_SMBUS: SMBus 5-pin connector (Pitch 2.54mm)

Pin	Signal
1	5V
2	NC
3	SMBDAT
4	SMBCLK
5	GND

CPUFAN: CPU cooler fan 4-pin connector

Pin	1	2	3	4
Signal	GND	12V	Sensor	Control

SYSFAN: System cooler fan 4-pin connector

Pin	1	2	3	4
Signal	GND	12V	Sensor	Control

2.5 <Power supply>

2.5.1 <Power input>

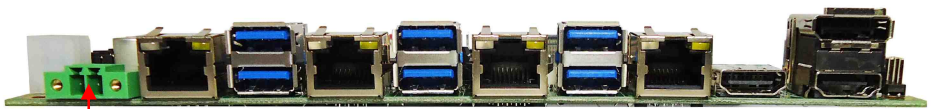
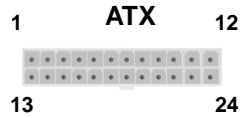
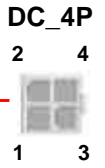
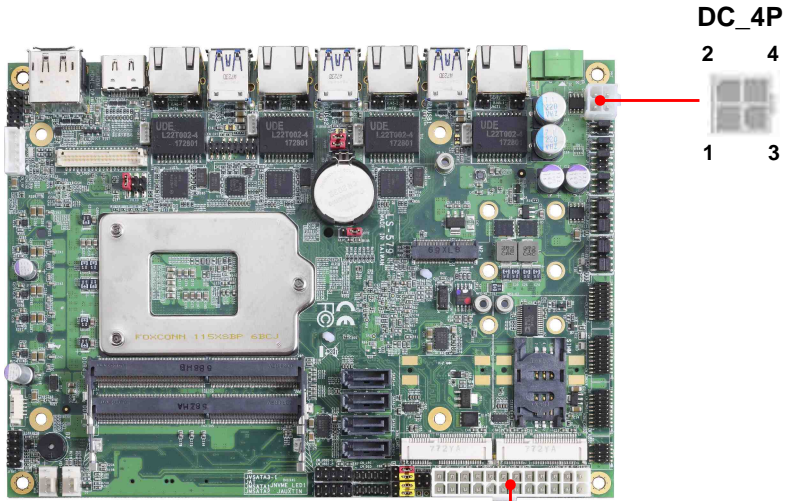

Plug

DC_2P



The DC_4P and DC_2P are CO-LAY design, support 9 ~ 35V wide voltage input.

Note that the DC_4P and ATX do not use at the same time, it will certainly cause damage.

DC_4P: ATX12V 4-pin connector

Pin	Signal	Pin	Signal
1	GND	2	GND
3	9~35V	4	9~35V

Note that the DC_2P and ATX do not use at the same time, it will certainly cause damage.

DC_2P: 2-pin Terminal Block connector

Pin	Signal	Pin	Signal
1	9~35V	3	GND

If the CPU TDP than 45W, please use ATX power

ATX: main power 24-pin connector (As input)

Pin	Signal	Pin	Signal
1	3.3V	13	3.3V
2	3.3V	14	NC
3	GND	15	GND
4	5V	16	-PSON
5	GND	17	GND
6	5V	18	GND
7	GND	19	GND
8	Power_OK	20	NC
9	5VSB	21	5V
10	12V	22	5V
11	12V	23	5V
12	3.3V	24	GND

Appendix A <Flash BIOS>

A.1 <Flash tool>

The board is based on Phoenix BIOS and can be updated easily by the BIOS auto flash tool. You can download the tool online at the address below:

[FPT TOOL](#)

The tool's file name is "fpt.exe", it's the utility that can write the data into the BIOS flash chip and update the BIOS.

A.2 <Flash BIOS process>

1. Please make a bootable UFD which can boot into DOS environment.
2. Unzip the flash tool and copy it into bootable UFD.
3. Add a bin file to the same folder..
4. Power on the system and flash the BIOS under the DOS environment.
(Command: fpt -savemac -f xxx.bin)
5. Power off the system and then power on.

Appendix B <LCD Panel Type select>

According your panel, it needs to select the correct resolution in the BIOS. If there is no fit your panel type, please feedback for us to make OEM model.

You can find the setting from

Advanced → Intel Advanced Menu

SA configuration → Graphics configuration → LCD control → LCD Panel Type

Phoenix SecureCore Technology Setup

Advanced

Intel Advanced Menu	Item Specific Help
PCI Subsystem Settings ACPI Settings CPU Configuration Power & Performance System Agent (SA) Configuration PGH-IO Configuration Manageability Application Configuration Super IO Chip	System Agent (SA) Parameters

F1 Help **Esc** Exit **↔** Select Item **↔** Select Menu **+/-** Change Values **Enter** Select Sub-Menu **F9** Setup Defaults **F10** Save and Exit

Phoenix SecureCore Technology Setup

Advanced

Graphics Configuration	Item Specific Help
Internal Graphics [Auto] GTI Size [8MB] Aperture Size [256MB] DUMI Pre-Allocated [32M] DUMI Total Gfx Mem [256M] Gfx Low Power Mode [Enabled] UDD Enable [Enabled] HDCP Support [Enabled] Algorithm [One-time] PM Support [Enabled] PAUP Enable [Enabled] Cd Clock Frequency [675 Mhz] IUSER Button Enable [Disabled] LCD Control Intel(R) Ultrabook Event Support	LCD Control

F1 Help **Esc** Exit **↔** Select Item **↔** Select Menu **+/-** Change Values **Enter** Select Sub-Menu **F9** Setup Defaults **F10** Save and Exit

BIOS panel type selection form (BIOS Version:1.0)			
Single / Dual channel		Single / Dual channel	
NO.	Type	NO.	Type
1	VBIOS DEFAULT	9	1366 x 768
2	640 x 480	10	1680 x 1050
3	800 x 600	11	1920 x 1200
4	1024 x 768	12	1400 x 900
5	1280 x 1024	13	1600 x 900
6	1400 x 1050 Reduced Blanking	14	1024 x 768
7	1400 x 1050 non-Reduced Blanking	15	1280 x 800
8	1600 x 1200	16	1920 x 1080
		17	OEM

Appendix C <Programmable Watch Dog Timer>

The watchdog timer makes the system auto-reset while it stops to work for a period. The integrated watchdog timer can be setup as system reset mode by program. You can select Timer setting in the BIOS, after setting the time options, the system will reset according to the period of your selection.

Find the setting from

Advanced → Intel Advanced Menu → Super IO Chip



Timeout value range

1 to 255 Minute and Second

Program sample

Watchdog timer setup as system reset with 5 second of timeout

- o 4E 87 ;enter configuration
- o 4E 87
- o 4E 07
- o 4F 08 ;select Logical Device
- o 4E 30

- o 4F 01 ; activate WDTO# function
- o 4E F0
- o 4F 00 ;set "00" is second mode, set "08" is minute mode
- o 4E F1
- o 4F 05 ;00h: Timeout Disable
- ;01h: Timeout occurs after 1 minute only
- ;02h: Timeout occurs after 2 second/minute
- ;03h: Timeout occurs after 3 second/minute
- ⋮
- ;FFh: Timeout occurs after 255 second/minute
- (The deviation is approx 1 second.)

For further information, please refer to Nuvoton NCT6106D datasheet

Appendix D <Hardware monitor >

Find the setting from Misc-ú SIO NCT6106D Hardware Monitor

Phoenix SecureCore Technology Setup	
Misc	
Hardware Monitor	Item Specific Help
System Temperature	[38.5 C]
CPU Temperature	[29.5 C]
System Fan Speed	[8 RPM]
CPU Fan Speed	[6585 RPM]
AUX Fan Speed	[8 RPM]
Battery 3V (VBAT)	[3.888 V]
CPU VCORE	[1.888 V]
12V	[11.985 V]
5V	[5.888 V]

F1 Help	Select Item	+/- Change Values	F9 Setup Defaults
Esc Exit	<> Select Menu	Enter Select Sub-Menu	F10 Save and Exit

Appendix E <Programmable GPIO >

The GPIO' can be programmed with the MS-DOS debug program using simple IN/OUT commands.

The DC characteristics please refer to GPIO paragraph (Page20).

GPIO	0	1	2	3	4	5	6	7
bit	0	1	2	3	4	5	6	7

- o 4E 87 ;enter configuration
- o 4E 87
- o 4E 07
- o 4F 07 ;select Logical Device
- o 4E 30
- o 4F 10 ;activate GPIO function (The board use GPIO4)
- o 4E F0
- o 4F XX ;set "01" GPIO as input, set "00" GPIO as output
- o 4E F1
- o 4F XX ;if set GPIO as output, this register's value can be set "00~ FF"

Optional

- o 4E F2
- o 4F XX ;set "01", the respective bit are inverted (Both input and output)
- ;set "00", the respective bit are normal

For further information, please refer to Nuvoton NCT6106D datasheet

Appendix F <RAID Setting>

When use RAID function, it need to enter the BIOS set RAID mode first.

Find the setting from

[Advanced] ú [Intel Advanced Menu] ú [PCH-IO Configuration]
 ú [SATA Configuration] ú [SATA Mode Selection]



SATA And RST Configuration ú Software Feature Mask Configuration
 Set Use RST Legacy OROM ú [Enable]

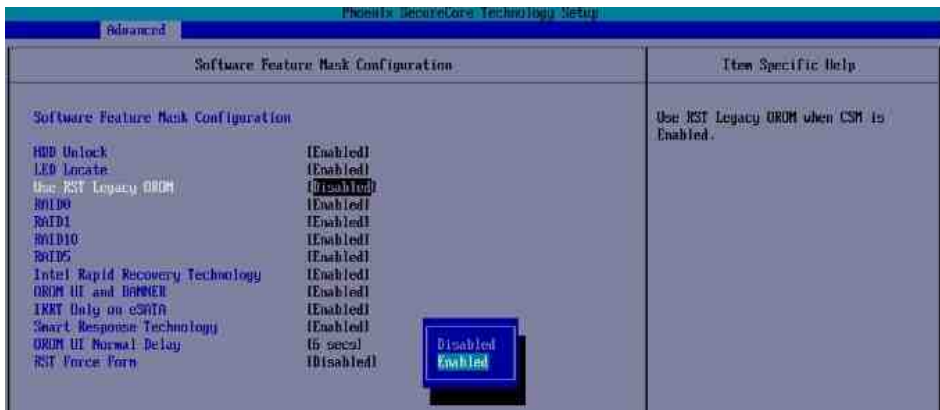

If this screen stop time is too short, it can be set in the BIOS.

- [Advanced] ú [Intel Advanced Menu] ú [PCH-IO Configuration]
- ú [SATA Configuration] ú [Software Feature Mask Configuration]
- ú [OROM UI Normal Delay] ú [8 sec] **(Need to set RAID mode first)**

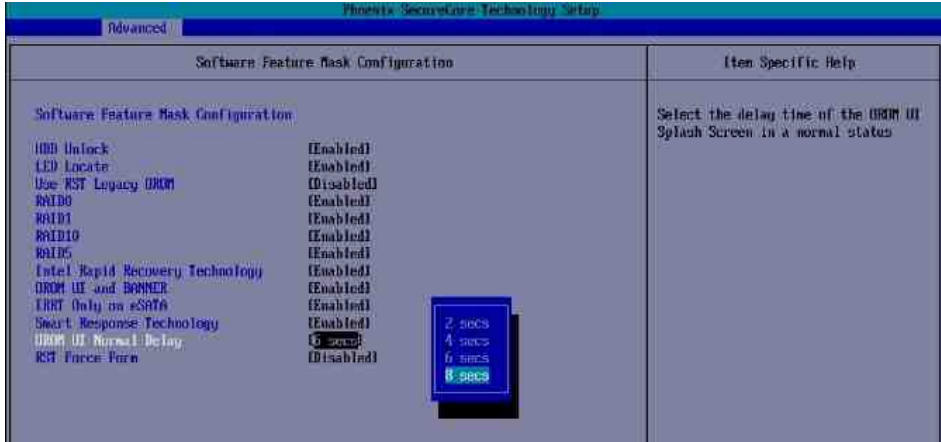

At boot time, press <CTRL + I> to enter the RAID configuration menu.



Appendix G < Setup ADP-3355,ADP-3460 >

LS-579T series have a 2nd CRT or 2nd LVDS, it's no need install extra driver.

For further information, please refer to the manual.

ADP-3355 manual [Link](#)

ADP-3460 manual [Link](#)

Appendix H < Setup PoE device >

LS-579 have two ways to support PoE function.

1. LS-579 work with [DC-DC5](#) and [ADP-PSE4](#)

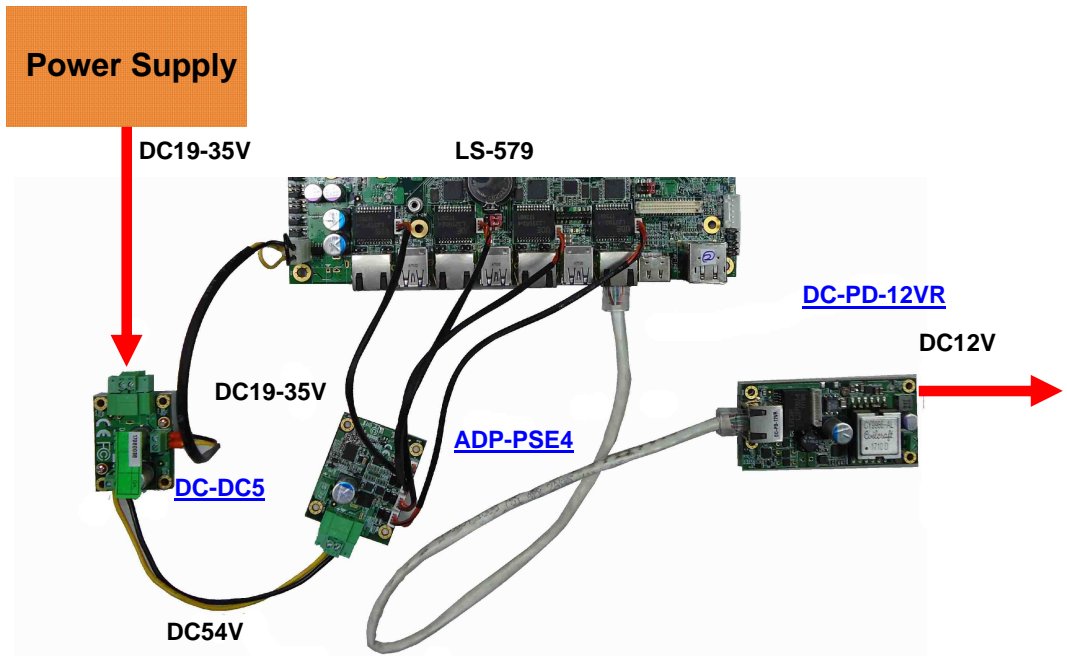

2. LS-579 work with [ADP-PSE4](#) and [DC-PD-12VT](#)

LS-579

[DC-PD-12VT](#)

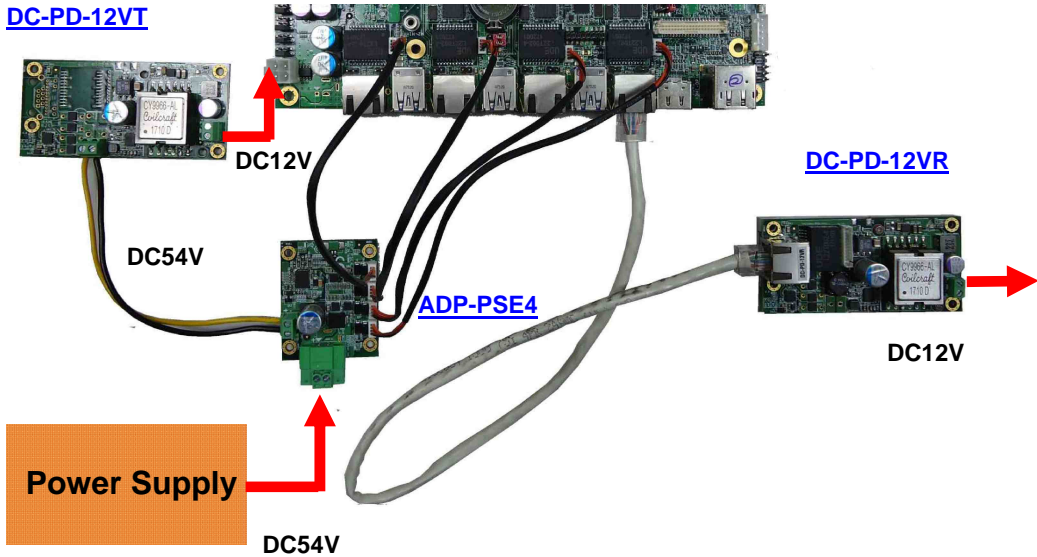

Contact information

Any advice or comment about our products and service, or anything we can help you please don't hesitate to contact with us. We will do our best to support you for your products, projects and business.

Taiwan Commate computer Inc.

Address	19F., NO.94, Sec. 1, Xintai 5 th Rd., Xizhi Dist., New Taipei City 22102, Taiwan.
TEL	+886-2-26963909
FAX	+886-2-26963911
Website	www.commell.com.tw
E-mail	info@commell.com.tw (General information) tech@commell.com.tw (Technical Support)

Commell is a brand name of Taiwan Commate computer Inc.