

# LV-67E

---

## Mini-ITX motherboard

### User's Manual

Edition: 1.2

2011/02/23

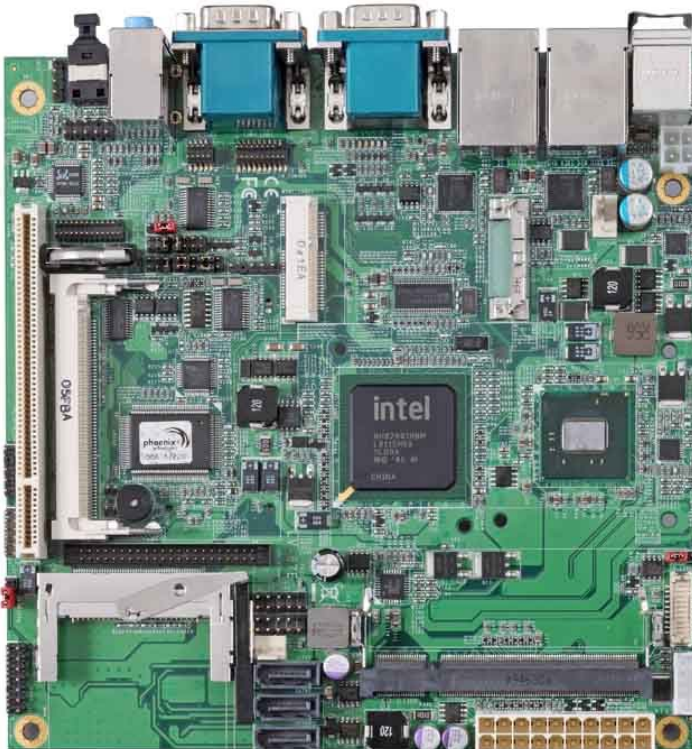

## **Copyright**

Copyright 2009. All rights reserved. This document is copyrighted and all rights are reserved. The information in this document is subject to change without prior notice to make improvements to the products.

This document contains proprietary information and protected by copyright. No part of this document may be reproduced, copied, or translated in any form or any means without prior written permission of the manufacturer.

All trademarks and/or registered trademarks contains in this document are property of their respective owners.

## **Disclaimer**

The company shall not be liable for any incidental or consequential damages resulting from the performance or use of this product.

The company does not issue a warranty of any kind, express or implied, including without limitation implied warranties of merchantability or fitness for a particular purpose.

The company has the right to revise the manual or include changes in the specifications of the product described within it at any time without notice and without obligation to notify any person of such revision or changes.

## **Trademark**

All trademarks are the property of their respective holders.

---

Any questions please visit our website at <http://www.commell.com.tw>.

# Packing List

Please check package component before you use our products.

## Hardware:

LV-67E Mini-ITX motherboard x 1

## Cable Kit:



**SATA Cable x 1**  
(OALSATA-L)



**DC Power Cable x 1**  
(OALDC-2)  
(OSCREW-8) \* 2

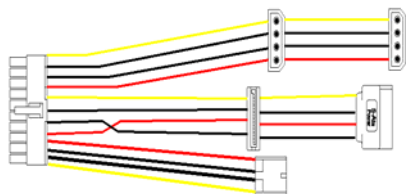

**ATX Power Output Cable x 1**  
(OALATX-P3S2)

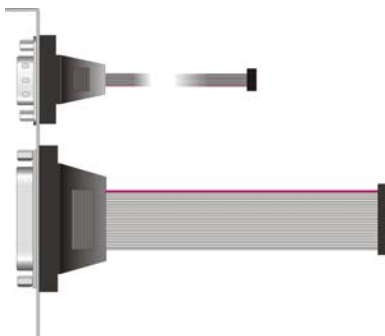

**COM port & Printer Port Cable x 1**  
(OALEB-KU-3)

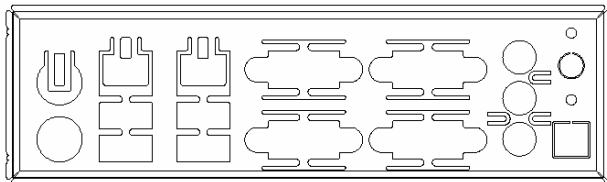

**I/O Shield x 1**  
(OPLATE-LV67E)



**LV-67EH/A/C Heatsink with Fan x 1**  
(OHS-67EF)

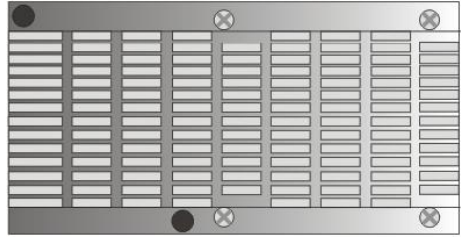

**LV-67EG/9 Heatsink x 1**  
(OHS-67E)

### **Optional Cable:**

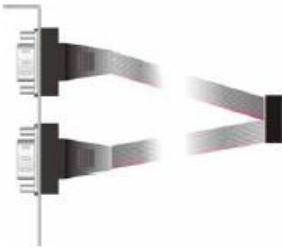

**Dual COM Port Cable x 1**  
(OALES-BKU2)

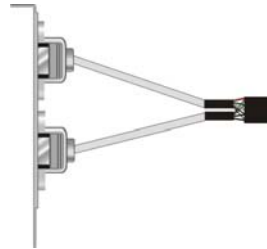

**USB Cable x 1**  
(OALUSBA-3)

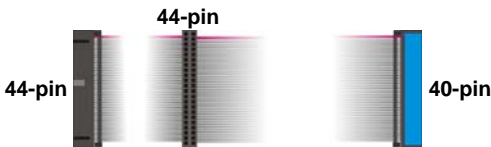

**ATA33 IDE Cable x 1**  
(OALUDMA33-8)

### **Other Accessories:**

**Divers CD (including User's Manual) x 1**

# Index

<b>Chapter1 &lt;Introduction&gt;</b> .....	<b>8</b>
1.1 <Product Overview> .....	8
1.2 <Product Specification> .....	9
1.3 <Block Diagram> .....	11
1.4 <Mechanical Drawing > .....	12
<b>Chapter 2 &lt;Hardware Setup&gt;</b> .....	<b>13</b>
2.1 <Connector Location>.....	13
2.2 <Jumper Reference> .....	15
2.3 <Connector Reference>.....	16
2.3.1 <Internal Connectors> .....	16
2.3.2 <External Connectors>.....	16
2.4 <Memory Setup> .....	17
2.5 <CMOS & ATX Setup>.....	18
2.6 <Enhanced IDE & CF Interface>.....	19
2.7<Serial ATA Interface>.....	20
2.8 <Network Interface>.....	21
2.9 <Onboard Display Interface> .....	22
2.9.1 <Analog Display> .....	22
2.9.2 <Digital Display Interface>.....	23
2.10 <Audio Interface>.....	27
2.11 <GPIO and SMBUS Interface> .....	29
2.12 <USB Interface> .....	30
2.13 <Power Supply and Fan Interface>.....	32
2.13.1 <Power Input> .....	32
2.13.2 <Power Output> .....	33
2.13.3 <Fan connector>.....	34
2.14 <Serial Port>.....	35
2.15 <Switch and Indicator> .....	38

<b>Chapter 3 &lt;System Configuration&gt;</b> .....	<b>40</b>
3.1 <Audio Configuration> .....	40
3.2 <Video Memory Setup> .....	41
3.3 <Display Properties Setting>.....	43
<b>Chapter 4 &lt;BIOS Setup&gt;</b> .....	<b>46</b>
<b>Appendix A &lt;I/O Port Pin Assignment&gt;</b> .....	<b>48</b>
A.1 < IDE Port > .....	48
A.2 < Serial ATA Port >.....	48
A.3 < IrDA Port >.....	49
A.4 < GPIO Port >.....	49
A.5 < USB Interface > .....	49
A.7 < Parallel Port >.....	53
A.8 < VGA Port > .....	53
A.9 < LAN Port >.....	54
A.10 < SMBus >.....	54
<b>Appedix B &lt;System Resources&gt;</b> .....	<b>55</b>
B.1 < I/O Port Address Map > .....	55
B.2 < Memory Address Map > .....	57
B.3 < System IRQ Resources > .....	58
B.4 < System DMA Resources >.....	58
<b>Appedix C &lt;Flash BIOS&gt;</b> .....	<b>59</b>
C.1 <BIOS Auto Flash Tool> .....	59
C.2 <Flash Method> .....	59
<b>Appendix D &lt;Programming GPIO's&gt;</b> .....	<b>60</b>
<b>Appendix E &lt;Watch Dog timer Setting &gt;</b> .....	<b>61</b>
<b>Contact Information</b> .....	<b>62</b>

**(This Page is Left for Blank)**

## Chapter1 <Introduction>

### 1.1 <Product Overview>

**LV-67EG/A/H/C/9** is the Mini-ITX motherboard with Intel® Atom™ N450/D410/D510/D525 /N455 Processor, integrated GMA3150 graphics, Intel® ICH8-M, DDR2 SO-DIMM memory, Realtek HD Audio, IDE, CF, SATAII and Intel® 82583V Gigabit LAN.

#### **Intel® Atom Processor**

The Intel® Atom™ N450/D410/D510/D525/N455 processor supports one channel of 667 MHz DDR2 SDRAM, 512KB/512KB/1MB/1MB/512KB L2 cache, for 45nm processor technology support Hyper-Threading Technology, the chipset features power-efficient graphics with Intel® Graphics Media Accelerator 3150 for an integrated 18-bit 3D graphics engine. The DMI is designed into the Pineview-M(D) processor to provide an efficient high-bandwidth communication channel between the processor and the ICH8M.

#### **Embedded Intel® ICH8-M chipset**

The board integrates Intel® ICH8M. It provides I/O capabilities and flexibility via high-bandwidth interfaces such as PCIE and Hi-Speed USB 2.0 connectivity. Serial ATA II. IDE, HD Audio.

#### **Flexible Extension Interface**

The board provides one PCI-slot for graphics card, it also can support PCI-slot for LAN card or other devices. The board also provides mini-PCI socket, Compact Flash Type II socket and two PCI-E Mini Card socket.



## 1.2 <Product Specification>

### General Specification

Form Factor	Mini-ITX motherboard
CPU	Intel® Atom N450 / N455 Processor 1.66GHz (LV-67EG / LV-67E9) Intel® Atom D410 / D510 Processor 1.66GHz (LV-67EH / LV-67EA) Intel® Atom D525 Processor 1.8GHz (LV-67EC) Package type: FCBGA559
Memory	1 x 200-pin DDR2 SO-DIMM 667MHz SDRAM up to 2GB/4GB/4GB/4GB/2GB (LV-67EG / LV-67EH / LV-67EA / LV-67EC / LV-67E9) Unbuffered, none-ECC memory supported only
Chipset	Intel® ICH8M
BIOS	Phoenix-Award v6.00PG 8Mb SPI flash BIOS
Green Function	Power saving mode includes doze, standby and suspend modes. ACPI version 2.0 and APM version 1.2 compliant
Watchdog Timer	System reset programmable watchdog timer with 1 ~ 255 sec./min. of timeout value
Real Time Clock	Intel® ICH8-M built-in RTC with lithium battery
Enhanced IDE	IDE supports 44-Pin Disk On Module with +5V power supply One CompactFlash Type II socket on solder side
Serial ATAII	Intel® ICH8M integrates 3 Serial ATAII interfaces (No RAID Function) Up to 300MB/s of transfer rate

### Multi-I/O Port

Chipset	Intel® ICH8M with Winbond® W83627DHG-P controller
Serial Port	Five RS-232 and one RS232/422/485 serial ports
USB Port	Eight Hi-Speed USB 2.0 ports with 480Mbps of transfer rate
IrDA Port	One IrDA compliant Infrared interface supports SIR
K/B & Mouse	External PS/2 keyboard and mouse ports on rear I/O panel
GPIO	One 12-pin Digital I/O connector with 8-bit programmable I/O interface
Smart Fan	One CPU fan connectors for fan speed controllable

### VGA Display Interface

Chipset	Intel® Atom N450 processor (System Controller Hub) (LV-67EG) Intel® Atom D410 processor (System Controller Hub) (LV-67EH) Intel® Atom D510 processor (System Controller Hub) (LV-67EA) Intel® Atom D525 processor (System Controller Hub) (LV-67EC) Intel® Atom N455 processor (System Controller Hub) (LV-67E9)
Frame Buffer	Up to 384MB shared with system memory
Display Type	CRT, LVDS, LCD monitor with analog display
Connector	External DB15 female connector on rear I/O panel Onboard 20-Pin LVDS and 5-Pin inverter connector

**Ethernet Interface**

Controller	2 x Intel® 82583V Gigabit Ethernet controller
Type	Triple speed 10/100/1000Base-T Auto-switching Fast Ethernet Full duplex, IEEE802.3U compliant
Connector	Two External RJ45 connectors with LED on rear I/O panel

**Audio Interface**

Chipset	Intel® ICH8M with Realtek ALC888 HD Audio Intel High Definition Audio compliance
Interface	2 channels sound output
Connector	External 3 phone jack for 2 channel audio on rear I/O panel External SPDIF connector on rear I/O panel Internal 10-pin header for line-out, MIC-in, 4-pin header for CD-IN

**Expansive Interface**

PCI	PCI slot (32-bit, 33MHz) Power supply: +3.3V, +5V, 3VSB +12V, -12V
Mini PCI	One Mini-PCI socket <b>TYPE III A</b> (32-bit, 33MHz) Power supply: +3.3V, +5V, 3VSB
PCIE mini card	Two PCIE mini card socket Power supply: +1.5V, 3VSB

**Power and Environment**

Power Requirement	Standard 20-pin ATX power supply or 9~24V full range DC Input
Dimension	170 (L) x 170 (H) mm
Temperature	Operating within 0 ~ 60°C (32 ~ 140°F) Storage within -20 ~ 85°C (-4 ~ 185°F)

**Ordering Code**

<b>LV-67EG</b>	Support Intel® Atom <b>N450 / D410 / D510 / D525 /N455</b> processor
<b>LV-67EH</b>	with onboard VGA, LVDS for 18-bits, Audio, Giga LAN, USB2.0,
<b>LV-67EA</b>	SATAII, PCIE mini card, PCI, Mini-PCI, Serial Port, CF, SMBUS,
<b>LV-67EC</b>	GPIO, IrDA, LPT, CDIN, SPDIF
<b>LV-67E9</b>	

The specifications may be different as the actual production.

For further product information please visit the website at <http://www.comnell.com.tw>

### 1.3 <Block Diagram>

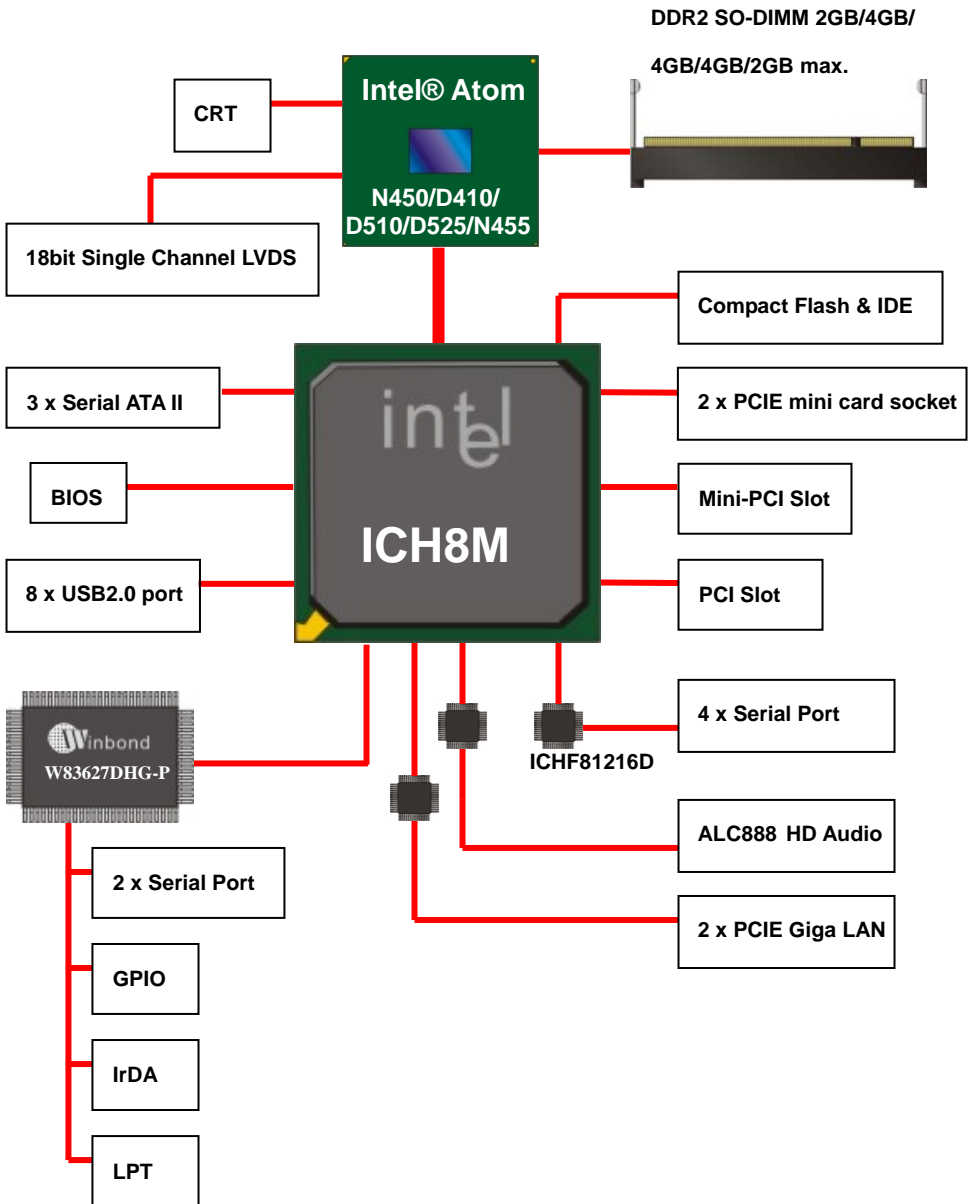

## 1.4 <Mechanical Drawing >

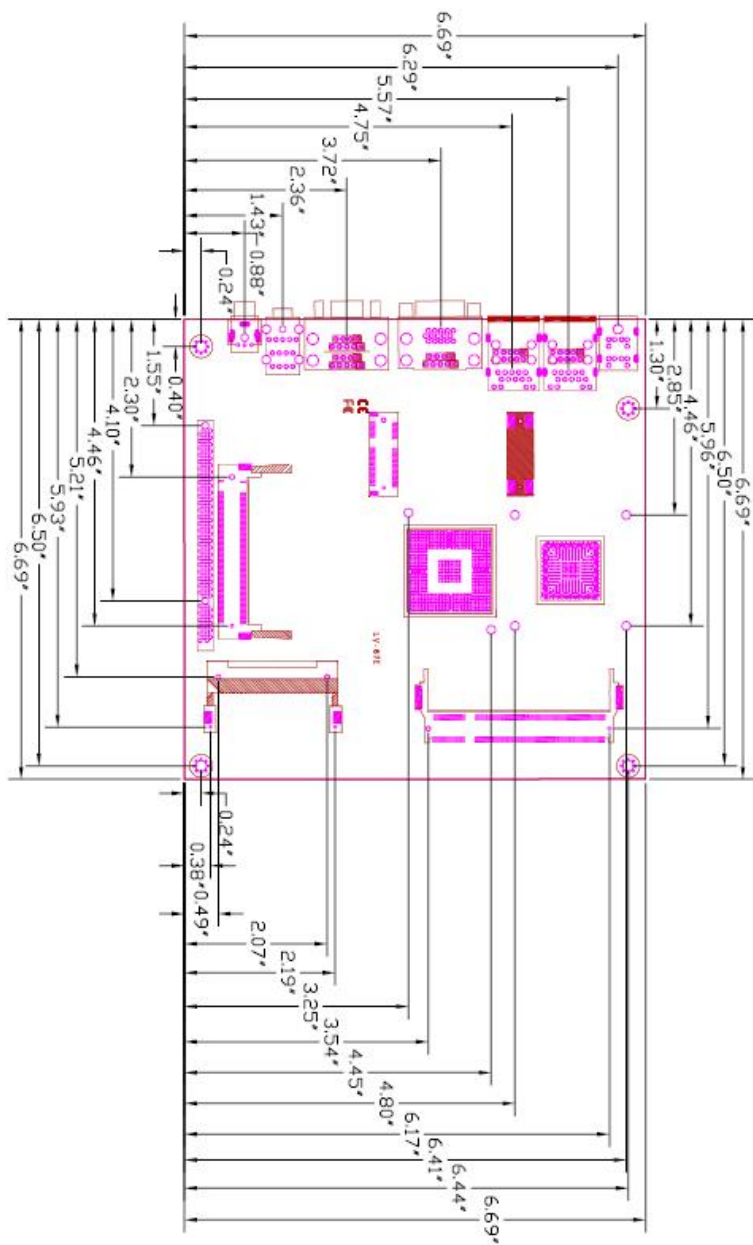

Unit: inch

## Chapter 2 <Hardware Setup>

### 2.1 <Connector Location>

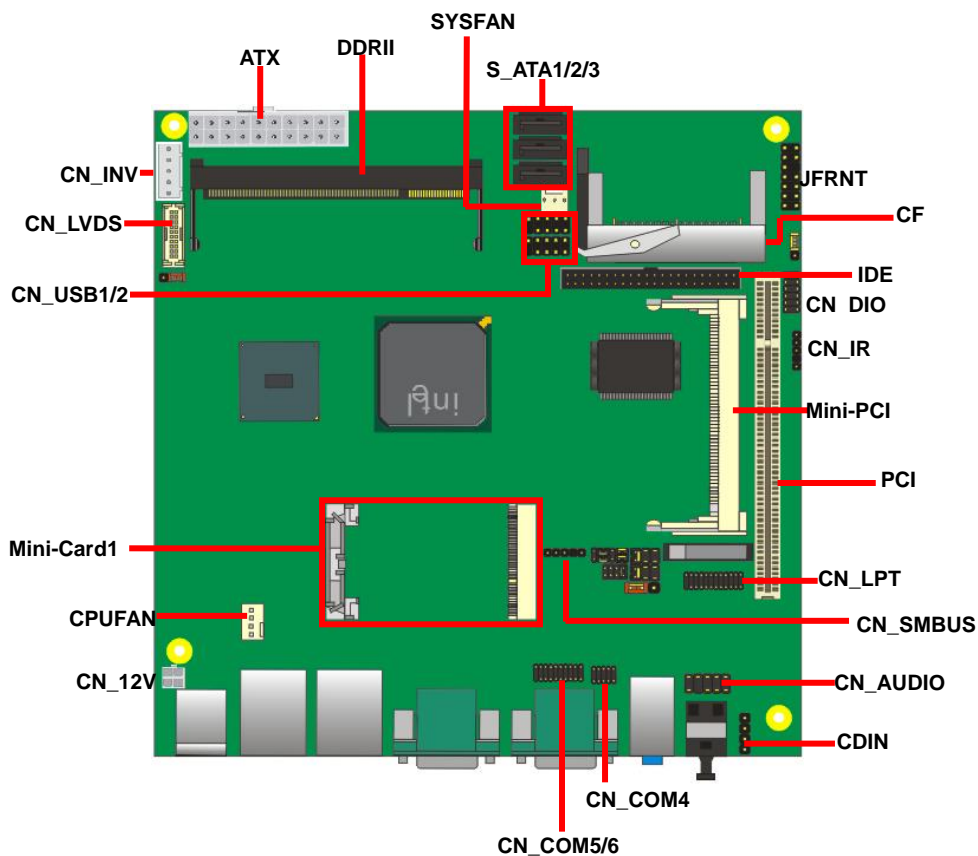

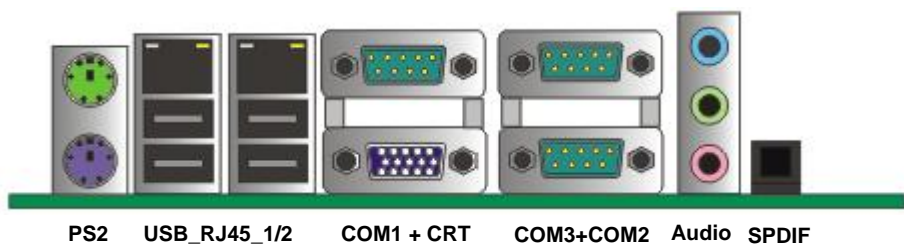
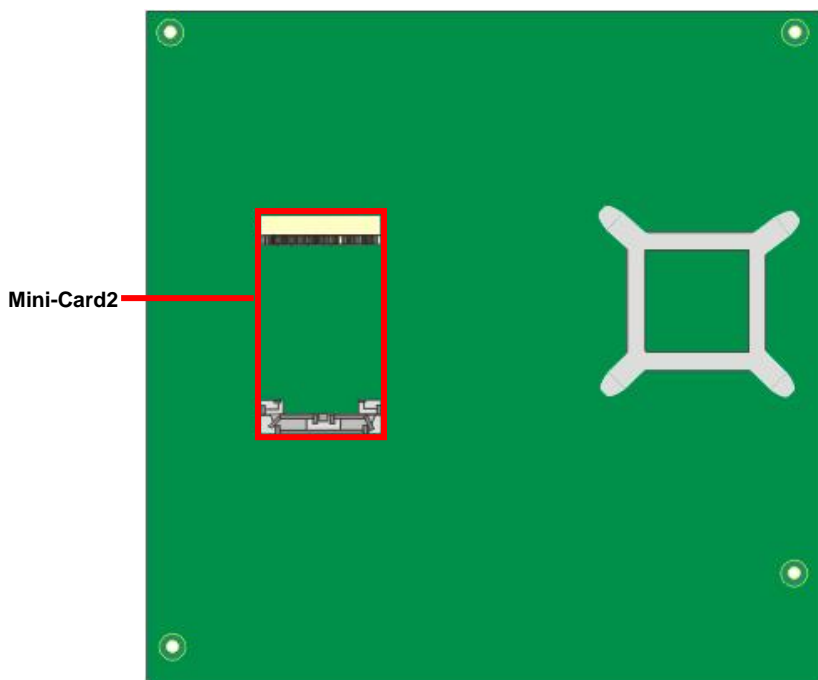

## 2.2 <Jumper Reference>

Jumper	Function
JRTC	CMOS Operating/Clear Setting
JVLCD	Panel Voltage Setting
JP39	COM3 signal mode switch (For Pin-9)
JP49	COM4 signal mode switch (For Pin-9)
JAT	Power mode select
JCSEL1	CN_COM2 RS-232 RS422 RS485 Setting
JCSEL2	CN_IR IrDA Setting

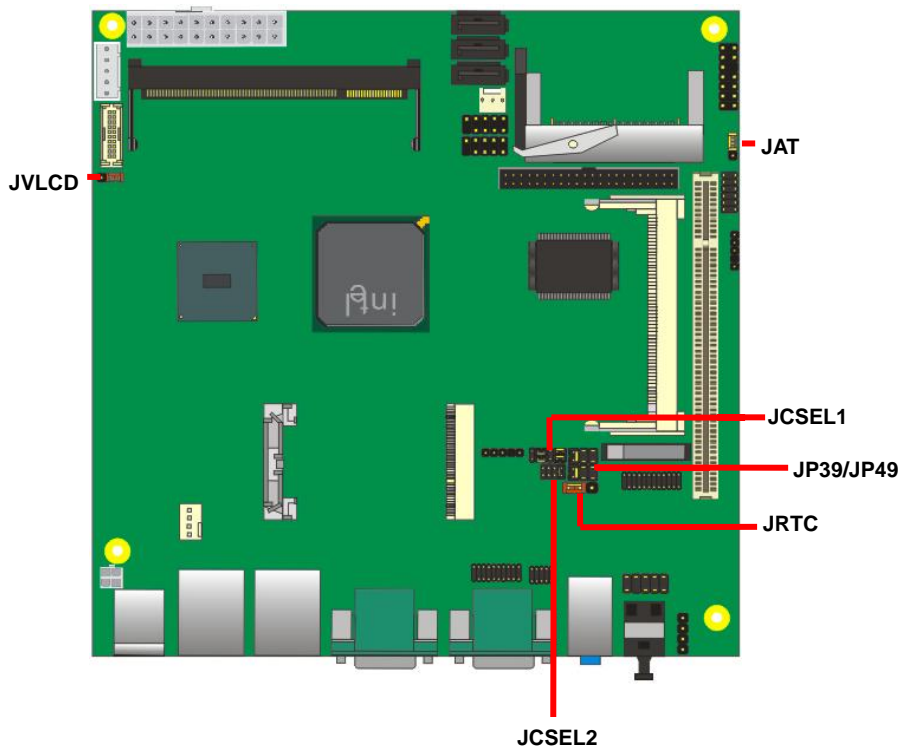

## 2.3 <Connector Reference>

### 2.3.1 <Internal Connectors>

Connector	Function	Remark
DDRIII1/2	200 -pin DDR2 SO-DIMM SDRAM slot	
S_ATAII1/2/3	7-pin Serial ATA II connector	
IDE	44-pin primary IDE connector	
CF	Compact Flash Type II socket	
ATX	24-pin power supply connector	
CN_12V	4-pin +12V additional power supply connector	
CN_AUDIO	5 x 2-pin audio connector	
CDIN	4-pin CD-ROM audio input connector	
CN_DIO	6 x 2-pin digital I/O connector	
CN_USB1/2	10-pin USB connector	
CPUFAN	4-pin CPU cooler fan connector	
SYSFAN	3-pin system cooler fan connector	
CN_IR	5-pin IrDA connector	
CN_COM4	5 x 2-pin RS232	
CN_COM56	10 x 2-pin 2 x RS232	
CN_LPT	13 x 2-pin printer connector	
CN_SMBUS	5-pin SMBUS connector	
CN_INV	5-pin LCD inverter connector	
CN_LVDS	20 x 2-pin LVDS connector	
JFRNT	14-pin front panel switch/indicator connector	
PCI	120-Pin PCI socket	
Mini-PCI	124-pin Mini-PCI socket	
MINI_CARD1/2	2 x 52-pin PCIE mini card socket	

### 2.3.2 <External Connectors>

Connector	Function	Remark
PS2	PS/2 Keyboard/Mouse connector	
CRT+COM1	DB15 VGA + Serial port connector	
USB_RJ45_1/2	Dual USB and one RJ45 LAN Port	
COM 2/3	Serial port connector	
AUDIO	Audio connectors	
SPDIF	SPDIF digital audio output connector	



## 2.4 <Memory Setup>

Non-ECC, unbuffered memory is supported only.

**LE-67EG/9** provides one 200-pin DDR2 SO-DIMM to support DDR2 667 memory modules support up to 2GB of capacity.

**Suggestion:**

DDR2 SO-DIMM Modules:

- Raw Card A = Double-sided x 16
- Raw Card C = Single-sided x 16

**LV-67EH/A/C** provides one 200-pin DDR2 SO-DIMM to support DDR2 667 memory modules support up to 4GB of capacity.

**Suggestion:**

DDR2 SO-DIMM Modules:

- Raw Card C = Single -sided x 16
- Raw Card D = Single -sided x 8
- Raw Card E = Double -sided x 8

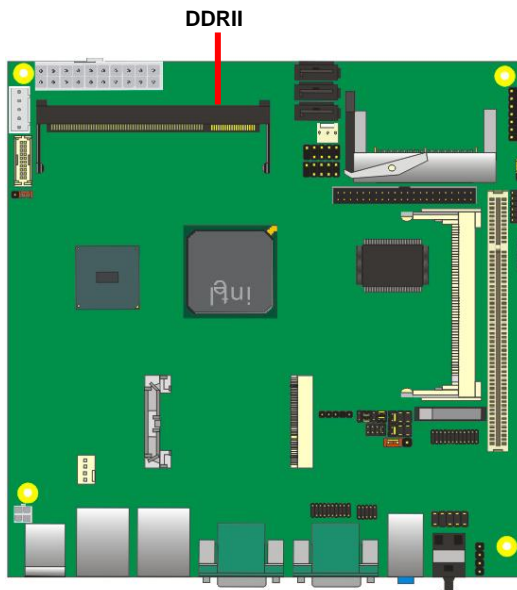

## 2.5 <CMOS & ATX Setup>

The board's data of CMOS can be setting in BIOS. If the board refuses to boot due to inappropriate CMOS settings, here is how to proceed to clear (reset) the CMOS to its default values.

Jumper: **JRTC**

Type: Onboard 3-pin jumper

JRTC	Mode
1-2	Clear CMOS
2-3	Normal Operation

Default setting

Jumper: **JAT**

Type: onboard 3-pin jumper

JAT	Mode
1-2	AT Mode
2-3	ATX Mode

Default setting

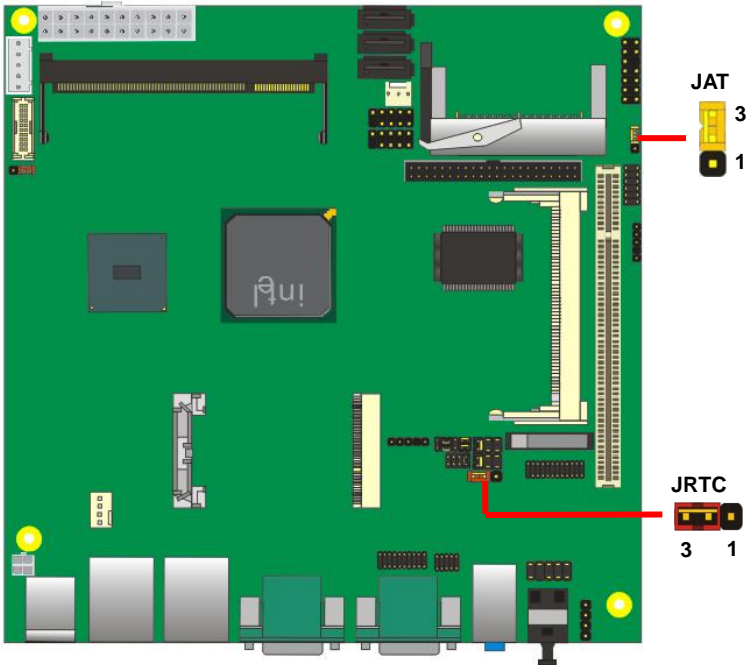

## 2.6 <Enhanced IDE & CF Interface>

The board supports one enhanced IDE interface for 2 ATAPI devices with ATA33. Based on embedded application, the board has one 44-pin IDE connector +5V supported for disk on module.

The board also provides a Compact Flash Type II socket.

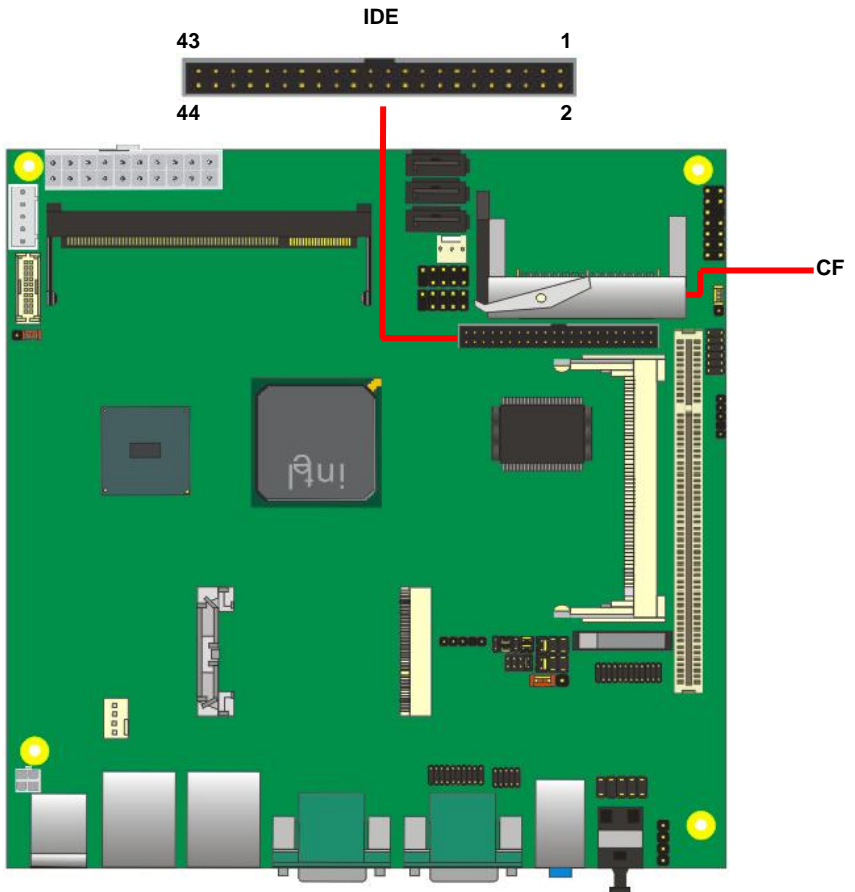

## 2.7<Serial ATA Interface>

Based on Intel® ICH8M, the board provides Three Serial ATAII interfaces with up to 300MB/s of transfer rate.

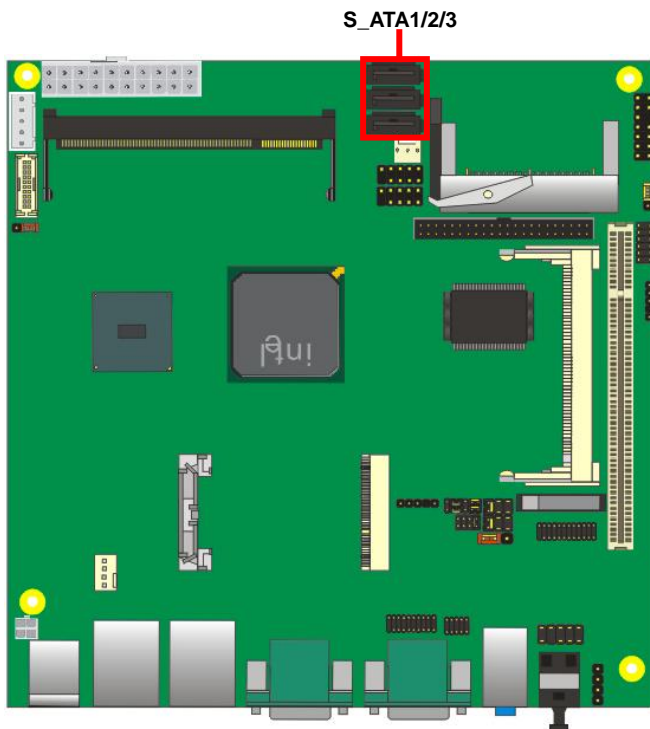

## 2.8 <Network Interface>

The board integrates with two Intel® 82583V Gigabit Ethernet controllers, as the PCI Express bus. The Intel® 82583V supports triple speed of 10/100/1000Base-T, with IEEE802.3 compliance and Wake-On-LAN supported.

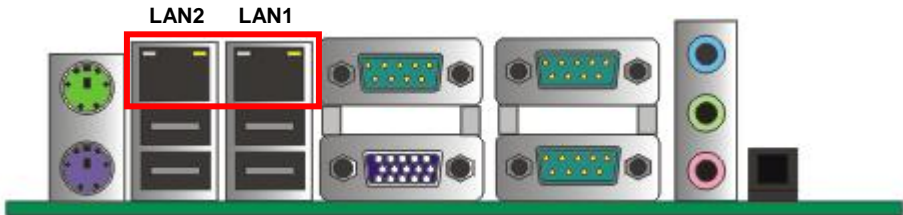

## **2.9 <Onboard Display Interface>**

Based on Intel® Atom N450/D410/D510/D525/N455 Processor with built-in graphics, the board provides one DB15 Connector on real external I/O port, and One 20-pin LVDS interface with 5-pin LCD backlight inverter connector. The board provides dual display function with clone mode and extended desktop mode for CRT and LVDS.

*Notice: When you install any PCI Graphic card, the onboard graphics would be disabled automatically.*

### **2.9.1 <Analog Display>**

Please connect your CRT or LCD monitor with DB15 male connector to the onboard DB15 female connector on rear I/O port.

LV-67EG/9 supports 1400 x 1050 (WUXGA) resolution displays.

LV-67EH/A/C supports 2048 x 1536 (WUXGA) resolution displays.

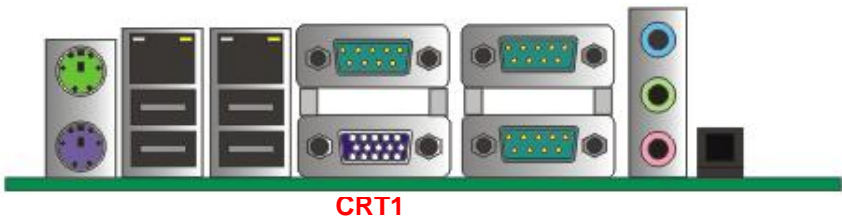

## **2.9.2 <Digital Display Interface>**

The board provides one 20-pin LVDS connector for 18-bit single channel panels.

LV-67EG/9 supports 1280 x 800 (WUXGA) of resolution, and LV-67E/H/A/C supports 1366 x 768 (WUXGA) of resolution, with one LCD backlight inverter connector and one jumper for panel voltage setting.

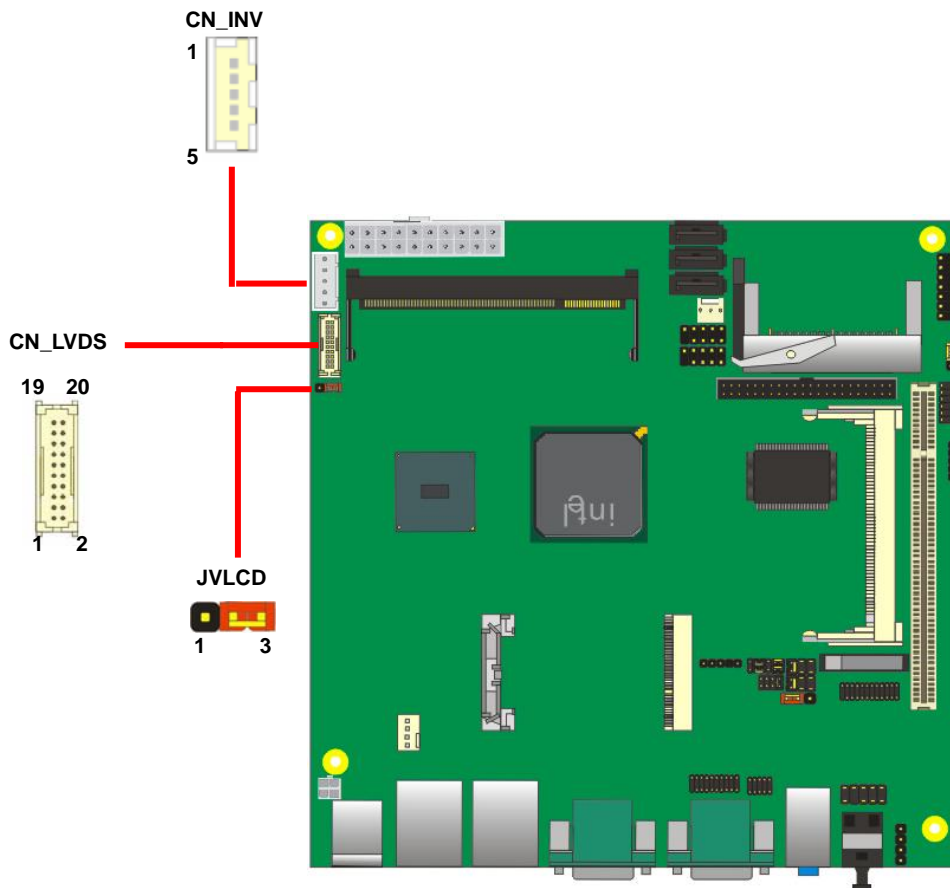

Connector: **CN\_INV**

Type: 5-pin Inverter power connector

Connector model: **molex\_53261-5pin**

Pin	Description
1	ENABKL
2	GND
3	GND
4	GND
5	+12V

Jumper: **JVLCD**

Type: 3-pin Power select jumper

Pin	Description
1-2	+5V
2-3	+3.3V

**Default: 2-3**Connector: **CN\_LVDS**

Type: onboard 20-pin connector for LVDS connector

Connector model: **HIROSE DF13-20DP-1.25V**

Pin	Signal	Pin	Signal
2	LCDVCC	1	LCDVCC
4	GND	3	GND
6	TXL0P	5	TXL0N
8	TXL1N	7	GND
10	GND	9	TXL1P
12	TXL2P	11	TXL2N
14	TXLCKN	13	GND
16	GND	15	TXLCKP
18	SMBDATA	17	SMBCLK
20	SPDIFO	19	GND



## LV-67E User's Manual

---

To setup the LCD, you need the component below:

1. A panel with LVDS interfaces.
2. An inverter for panel's backlight power.
3. A LCD cable and an inverter cable.

For the cables, please follow the pin assignment of the connector to make a cable, because every panel has its own pin assignment, so we do not provide a standard cable; please find a local cable manufacture to make cables.

### LCD Installation Guide:

1. Preparing the LV-67E, LCD panel and the backlight inverter.

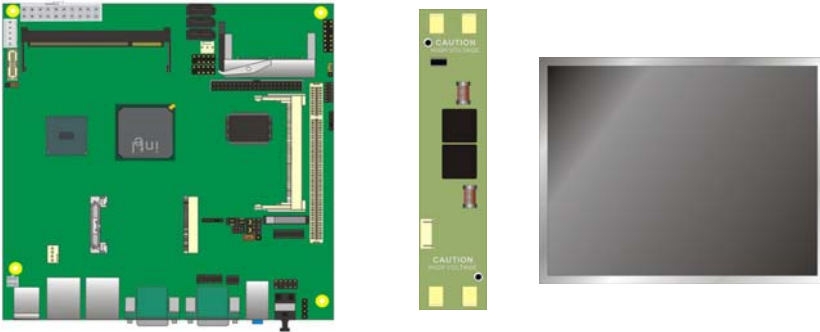

2. Please check the datasheet of the panel to see the voltage of the panel, and set the jumper **JVLCD** to +5V or +3.3V.
3. You would need a LVDS type cable.



4. To connect all of the devices well.

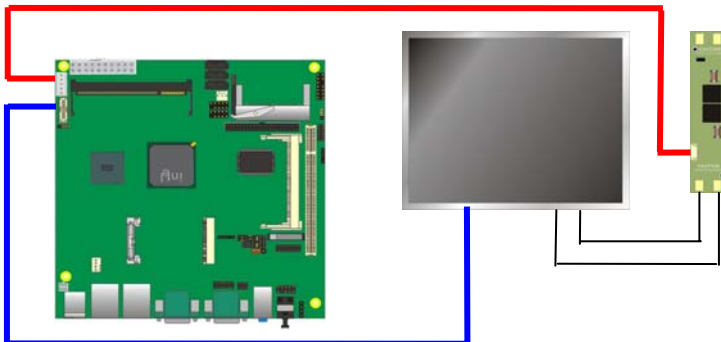

After setup the devices well, you need to select the LCD panel type in the BIOS.

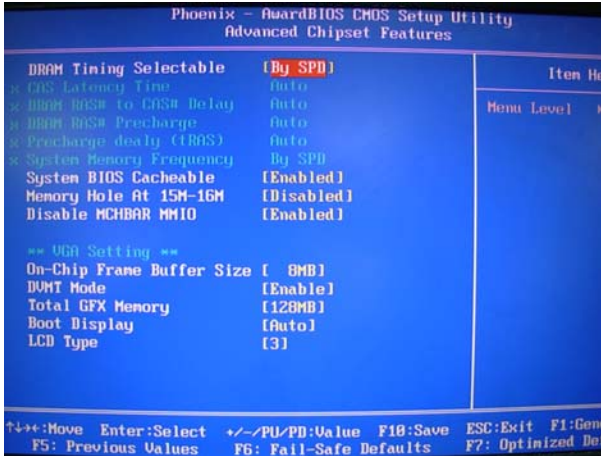

The panel type mapping is list below:

LV-67E BIOS panel type selection form	
On board Single channel LVDS	
18bit	
NO.	Output format
1	640 x 480
2	800 x 480
3	800 x 600
4	1024 x 600
5	1024 x 768
6	1280 x 768

## 2.10 <Audio Interface>

The board integrates onboard audio interface with REALTEK ALC888 codec, with Intel next generation of audio standard as High Definition Audio, it offers more vivid sound and other advantages than former HD audio compliance.

The main specifications of ALC888 are:

- **High-performance DACs with 100dB S/N ratio**
- **2 DAC channels support 16/20/24-bit PCM format for 2 audio solution**
- **16/20/24-bit S/PDIF-OUT supports 44.1K/48K/96kHz sample rate**
- **Compatible with HD**
- **Meets Microsoft WHQL/WLP 2.0 audio requirements**

The board provides 2 channels audio phone jacks on rear I/O port, Line-in/MIC-in ports for front I/O panel through optional cable.

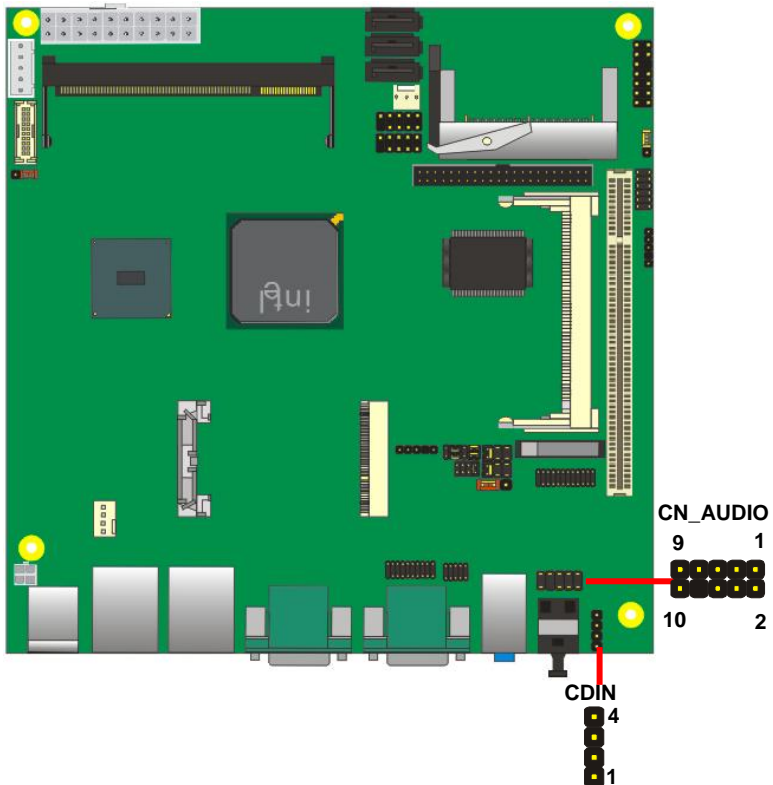

**Connector: CN\_AUDIO**

Type: 10-pin (2 x 5) header (pitch = 2.54mm)

Pin	Description	Pin	Description
1	MIC_L	2	Ground
3	MIC_R	4	N/C
5	LINE_OUT_R	6	MIC Detect
7	SENSE	8	N/C
9	LINE_OUT_L	10	Speaker Detect

**Connector: CDIN**

Type: 4-pin header (pitch = 2.54mm)

Pin	Description
1	CD – Left
2	Ground
3	Ground
4	CD – Right

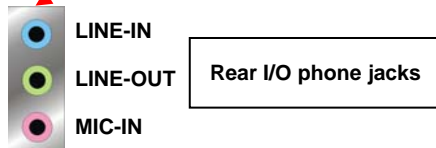
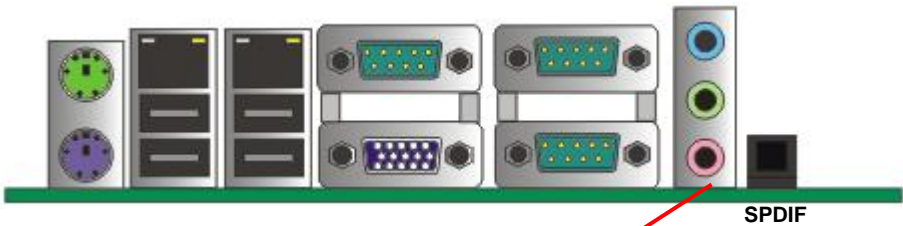

## 2.11 <GPIO and SMBUS Interface>

The board provides a programmable 8-bit digital I/O interface, and a SMBUS (System management bus) interface for control panel application.

Connector: **CN\_DIO**

Type: onboard 2 x 6-pin header, pitch=2.0mm

Pin	Description	Pin	Description
1	Ground	2	Ground
3	GP10	4	GP14
5	GP11	6	GP15
7	GP12	8	GP16
9	GP13	10	GP17
11	VCC	12	+12V

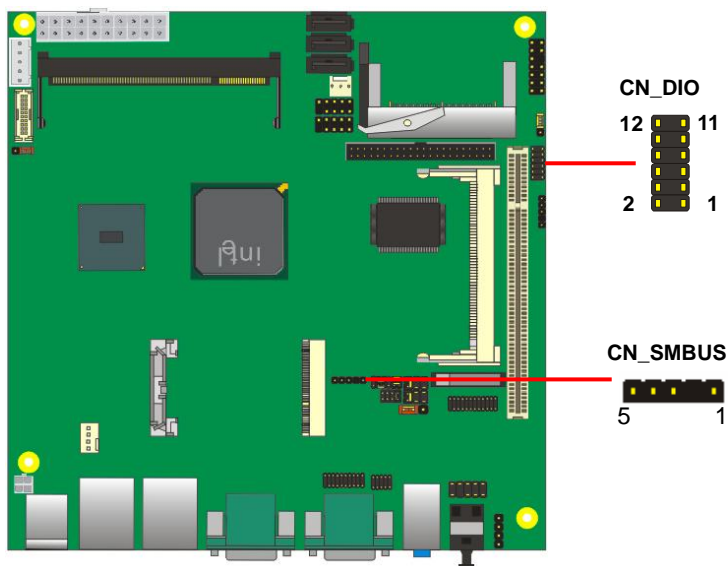

Connector: **CN\_SMBUS**

Type: 5-pin header for SMBUS Ports

Pin	Description
1	VCC
2	N/C
3	SMBDATA
4	SMBCLK
5	Ground

## 2.12 <USB Interface>

LV-67E integrates eight USB2.0 ports. The specifications of USB2.0 are listed below:

Interface	USB2.0
Controller	Intel® ICH8-M
Transfer Rate	Up to 480Mb/s
Voltage	5V

The Intel® ICH8-M contains two Enhanced Host Controller Interface (EHCI) and five Universal Host Controller Interfaces (UHCI), it can determine whether your connected device is for USB1.1 or USB2.0, and change the transfer rate automatically.

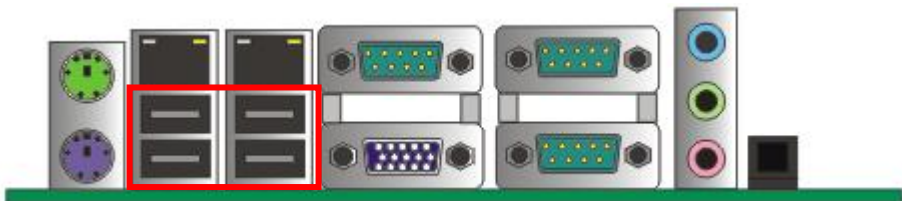

USB5/6/7/8

Connector: **CN\_USB1/2**

Type: 10-pin (5 x 2) header for USB5/6 Ports

Pin	Description	Pin	Description
1	VCC	2	VCC
3	Data0-	4	Data1-
5	Data0+	6	Data1+
7	Ground	8	Ground
9	Ground	10	N/C

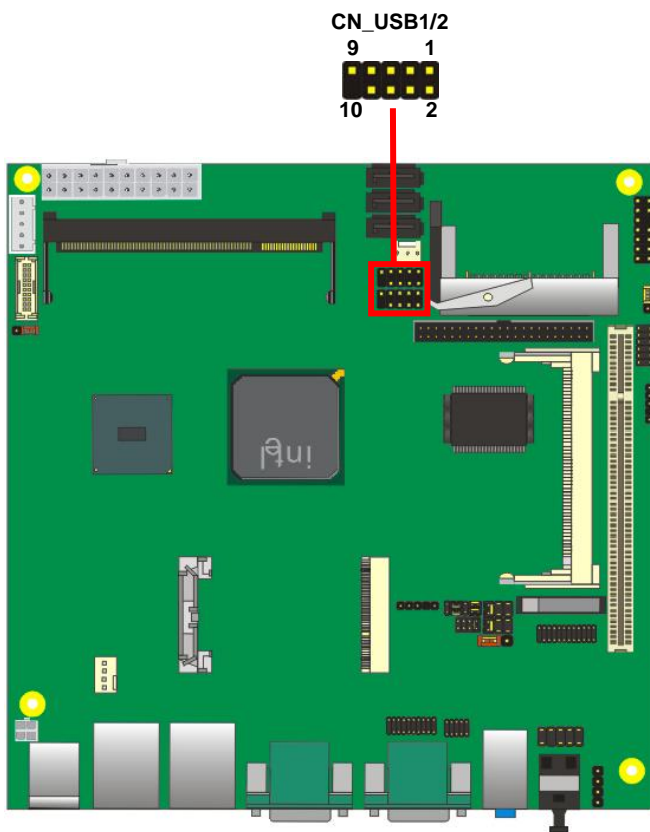

## 2.13 <Power Supply and Fan Interface>

### 2.13.1 <Power Input>

The board requires onboard **4-pin** DC-input connector voltage range is from 8V to 24V, or onboard **20-pin** ATX2.0, for the input current, please take a reference of the power consumption report on appendix.

Connector: **ATX** *(It also can become Output when DC-IN be used)*

Type: 20-pin ATX power connector

Pin	Assignment	Pin	Assignment
1	3.3V	11	3.3V
2	3.3V	12	-12V
3	GND	13	GND
4	5V	14	-PSON
5	GND	15	GND
6	5V	16	GND
7	GND	17	GND
8	PW_OK	18	N/C
9	5V_SB	19	5V
10	12V	20	5V

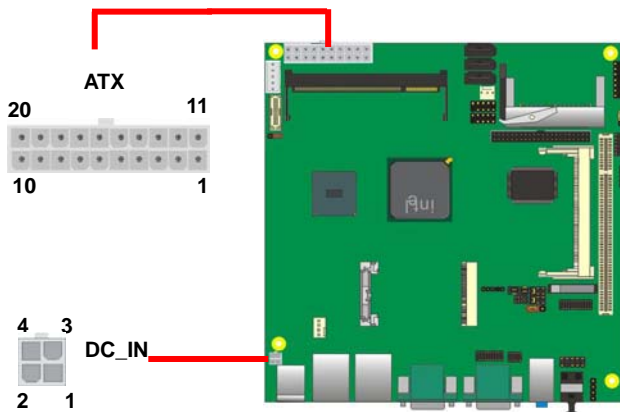

Connector: **DC\_IN**

Type: 4-pin standard Pentium 4 additional +9~24V power connector

Pin	Description	Pin	Description
1	Ground	2	Ground
3	+9~24V	4	+9~24V



### 2.13.2 <Power Output>

The board provides one 20-pin ATX connector for +5V/+12V output for powering your HDD, CDROM or other devices.

**Attention: When DC-IN had power supplied, the ATX become output !**

**Avoid DC-IN and ATX power supply input at the same time !**

Connector: **ATX** (When DC-IN be used)

Type: 20-pin ATX connector for +3.3V/+5V/+12V **Output**

Pin	Assignment	Pin	Assignment
1	3.3V	11	3.3V
2	3.3V	12	*
3	*	13	*
4	5V	14	*
5	GND	15	*
6	*	16	GND
7	GND	17	GND
8	*	18	*
9	*	19	5V
10	12V	20	5V

Note: Maximum output voltage: 12V/2A & 5V/3A & 3.3V/2A

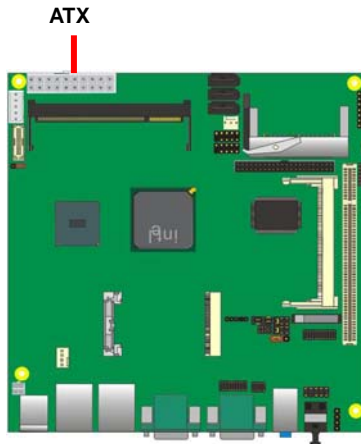

2.13.3 <Fan connector>

The board provides one **4-pin** fan connectors supporting smart fan for CPU cooler and one **3-pin** cooler fan connectors for system.

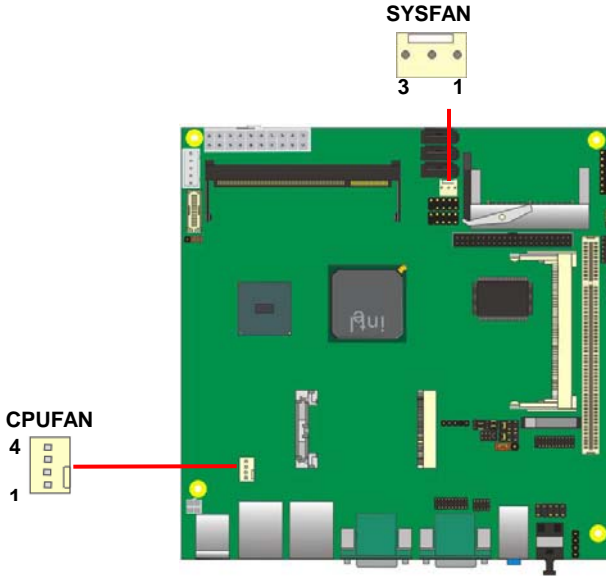

Connector: **CPUFAN**

Type: 4-pin fan wafer connector

Pin	Description	Pin	Description
1	Ground	2	+12V
3	Fan Speed Detection	4	Fan Control

Connector: **SYSFAN**

Type: 3-pin fan wafer connector

Pin	Description	Pin	Description	Pin	Description
1	Ground	2	+12V	3	Sense

## 2.14 <Serial Port>

The board supports Three RS232 serial port and one jumper selectable RS232/422/485 serial ports. The jumper JCSEL1 & JCSEL2 can let you configure the communicating modes for COM2.

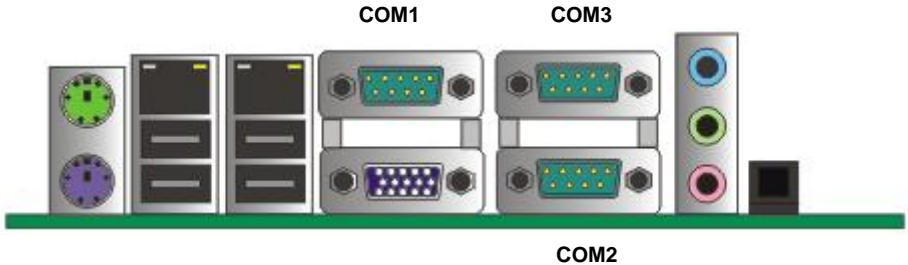

Connector: **COM2**

Type: 9-pin D-sub male connector on bracket for COM2

Pin	Description	Pin	Description
1	DCD/422TX-/485-	2	RXD/422TX+/485+
3	TXD/422RX+	4	DTR/422RX-
5	GND	6	DSR
7	RTS	8	CTS
9	RI	10	N/C

Setting RS-232 & RS-422 & RS-485 for COM2

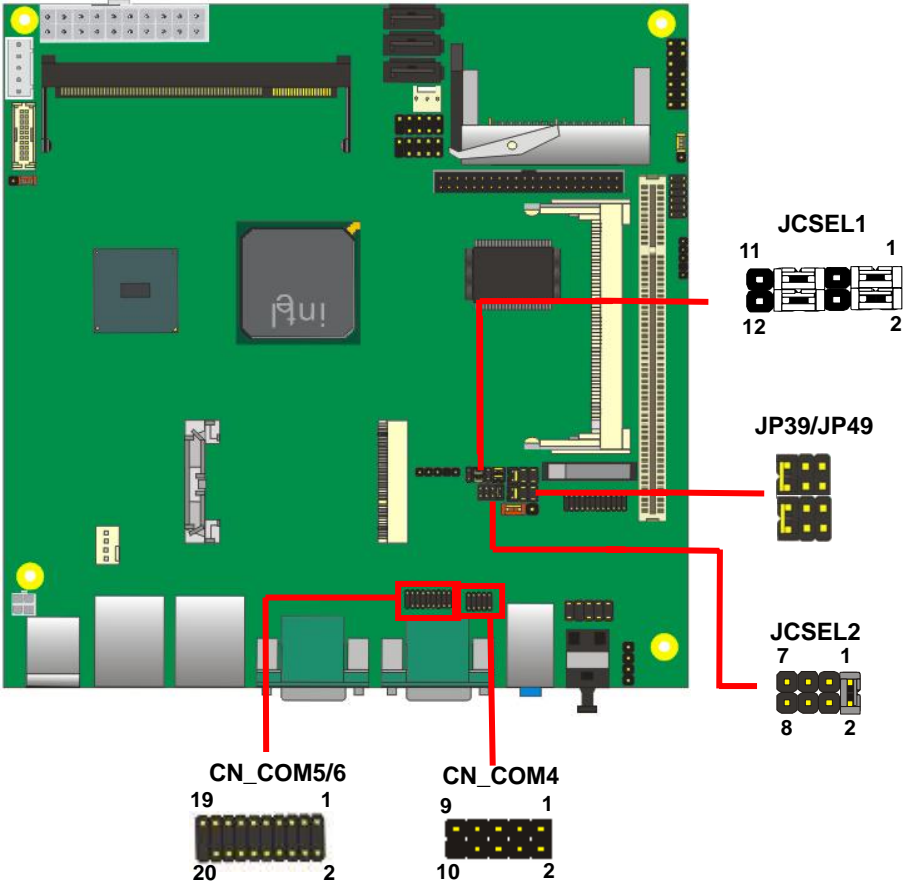

Function	JCSEL2	JCSEL1
IrDA		
RS-422		
RS-485		
RS-232		

Default setting:

**JCSEL1: (1-3, 2-4, 7-9, 8-10) JCSEL2: (1-2)**

Jumper: **JP39/JP49 (COM3/4)**

Type: onboard 6-pin header

Power Mode	JP39/JP49
Pin 9 with 5V Power	1-2
Pin 9 with 12V Power	3-4
<b>Default setting: 5-6</b>	

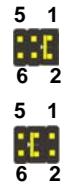

## 2.15 <Switch and Indicator>

The **JFRNT** provides front control panel of the board, such as power button, reset and beeper, etc. Please check well before you connecting the cables on the chassis.

Connector: **JFRNT**

Type: onboard 14-pin (2 x 7) 2.54-pitch header

Function	Signal	PIN		Signal	Function
IDE LED	HDLED+	1	2	PWDLED+	Power LED
	HDLED-	3	4	N/C	
Reset	Reset+	5	6	PWDLED-	Speaker
	Reset-	7	8	SPKIN+	
N/C		9	10	N/C	
Power Button	PWRBT+	11	12	N/C	
	PWRBT-	13	14	SPKIN-	

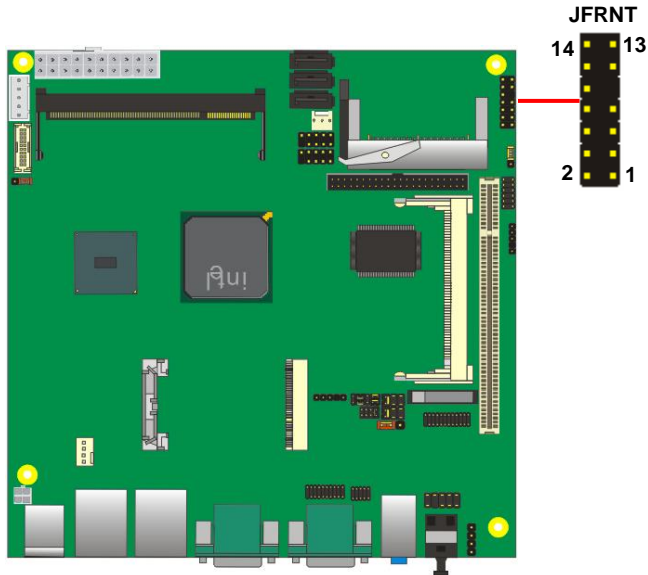

(This Page is Left for Blank)

## Chapter 3 <System Configuration>

### 3.1 <Audio Configuration>

The board integrates Intel® ICH8-M with REALTEK® ALC888 codec. It can support 2-channel sound under system configuration. Please follow the steps below to setup your sound system.

1. Install REALTEK HD Audio driver.

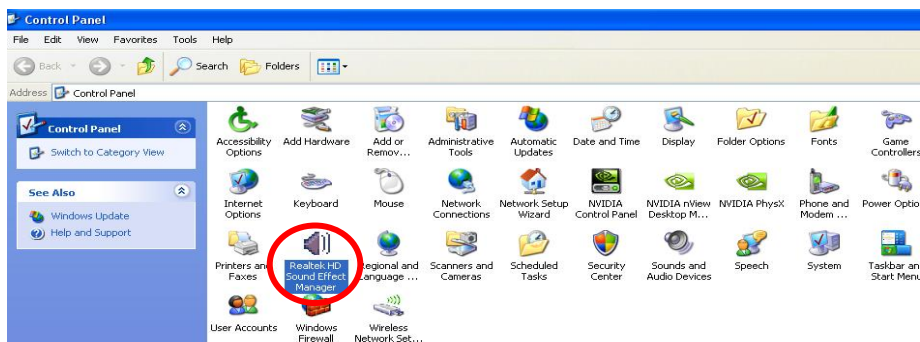

2. Launch the control panel and Sound Effect Manager.
3. Select Speaker Configuration



4. Select the sound mode to meet your speaker system.



## 3.2 <Video Memory Setup>

Based on Intel® Atom N450/D410/D510/D525/N455 chipset with GMA (Graphic Media Accelerator) 3150, the board supports Intel® DVMT (Dynamic Video Memory Technology) 3.0, which would allow the video memory be triggered up to 384MB.

To support DVMT, you need to install the Intel GMA3150 Driver with supported OS.

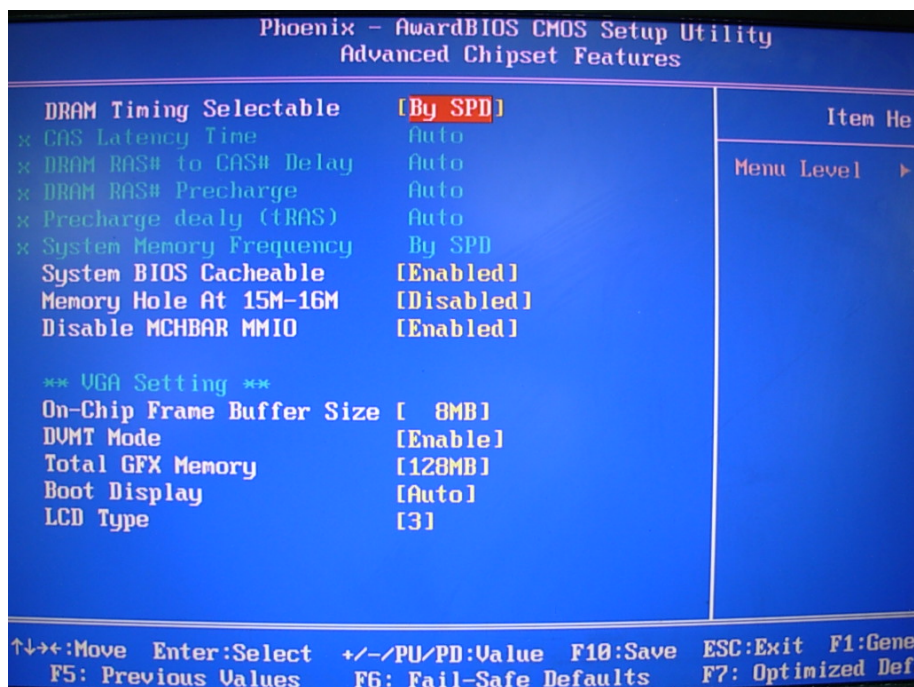

### BIOS Setup:

#### On-Chip Frame Buffer Size:

This item can let you select video memory which been allocated for legacy VGA and SVGA graphics support and compatibility. The available option is **1MB** and **8MB**.

### **Total GFX Memory Size:**

This item can let you select a static amount of page-locked graphics memory; which will be allocated during driver initialization. Once you select the memory amount, it will be no longer available for system memory.

### **DVMT Memory Size:**

This item can let you select a maximum size of dynamic amount usage of video memory, the system would configure the video memory depends on your application, this item is strongly recommend to be selected as **MAX DVMT**.

### **Fixed + DVMT Memory Size:**

You can select the fixed amount and the DVMT amount at the same time for a guaranteed video memory and additional dynamic video memory

Notice:

1. The On-Chip Frame Buffer Size would be included in the Total GFX Memory Size.

### 3.3 <Display Properties Setting>

Based on Intel® Atom N450/D410/D510/D525/N455 with GMA3150 (Graphic Media Accelerator), the board supports two DACs for display device as different resolution and color bit.

Please install the Intel Graphic Driver before you starting setup display devices.

1. Click right button on the desktop to lunch **display properties**

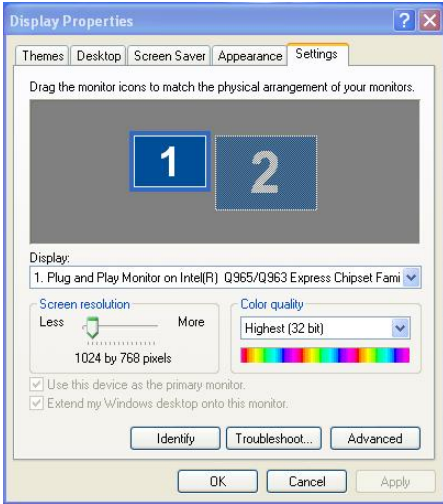

2. Click **Advanced** button for more specificity setup.

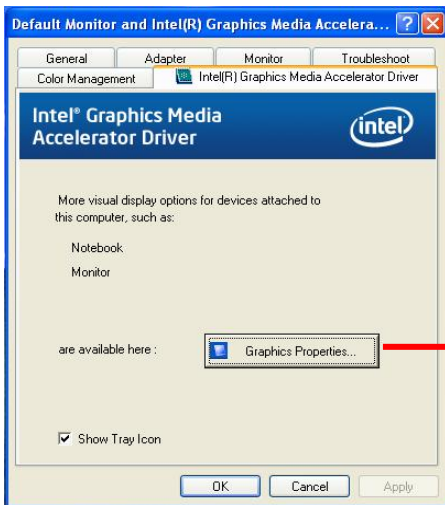

Click **Graphics Properties...** for advanced setup

3. This setup options can let you define each device settings.

Set the main display device here



Choose Intel<sup>®</sup> Dual Display Clone to setup the dual display mode as same screen

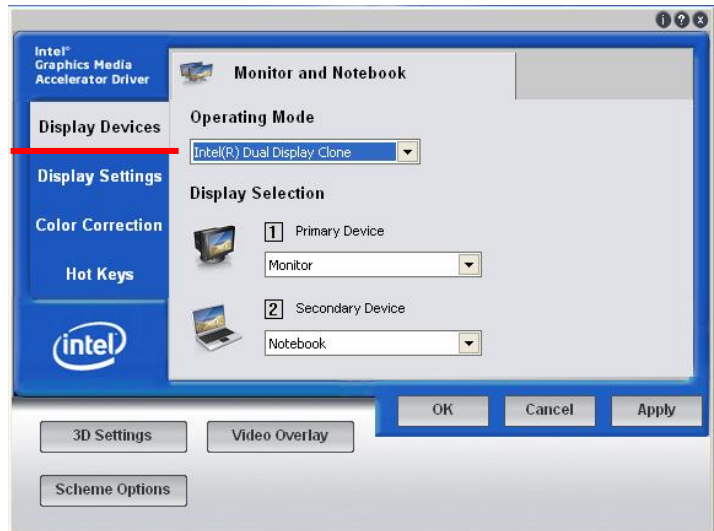

Choose **Extended Desktop** to setup the dual display mode as different screen display

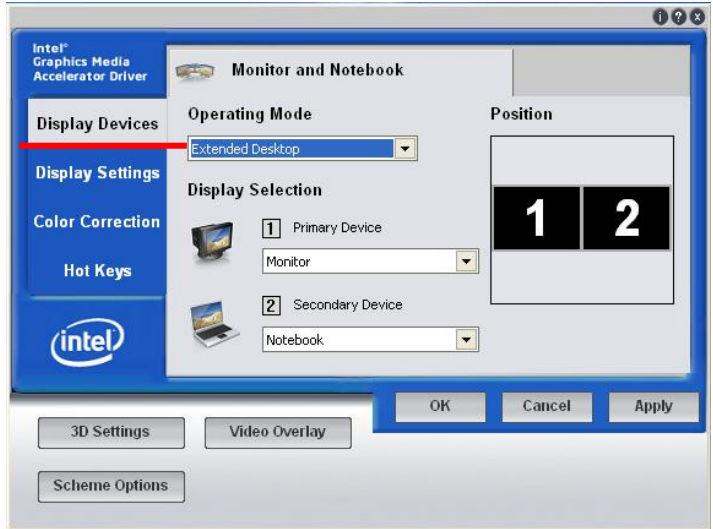

Choose **Monitor** to setup the CRT monitor for Colors, Resolution and Refresh Rate

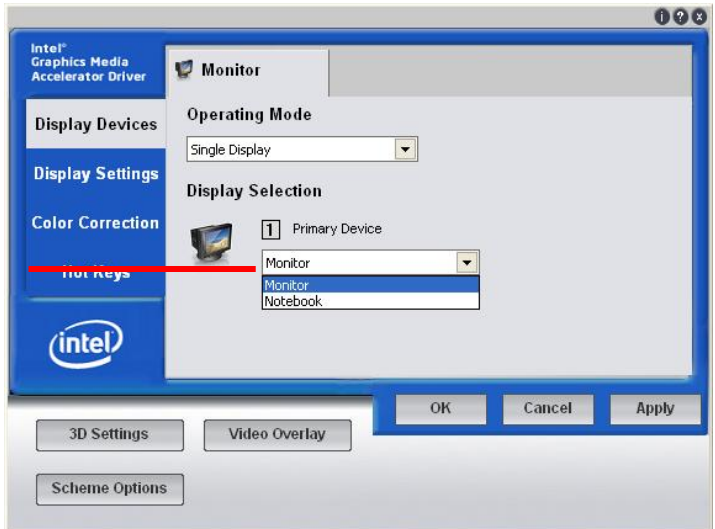

## Chapter 4 <BIOS Setup>

The motherboard uses the Award BIOS for the system configuration. The Award BIOS in the single board computer is a customized version of the industrial standard BIOS for IBM PC AT-compatible computers. It supports Intel® x86 and compatible CPU architecture based processors and computers. The BIOS provides critical low-level support for the system central processing, memory and I/O sub-systems.

The BIOS setup program of the single board computer let the customers modify the basic configuration setting. The settings are stored in a dedicated battery-backed memory, NVRAM, retains the information when the power is turned off. If the battery runs out of the power, then the settings of BIOS will come back to the default setting.

The BIOS section of the manual is subject to change without notice and is provided here for reference purpose only. The settings and configurations of the BIOS are current at the time of print, and therefore they may not be exactly the same as that displayed on your screen.

To activate CMOS Setup program, press <DEL> key immediately after you turn on the system. The following message "Press DEL to enter SETUP" should appear in the lower left hand corner of your screen. When you enter the CMOS Setup Utility, the Main Menu will be displayed as **Figure 4-1**. You can use arrow keys to select your function, press <Enter> key to accept the selection and enter the sub-menu.

**Figure 4-1** CMOS Setup Utility Main Screen

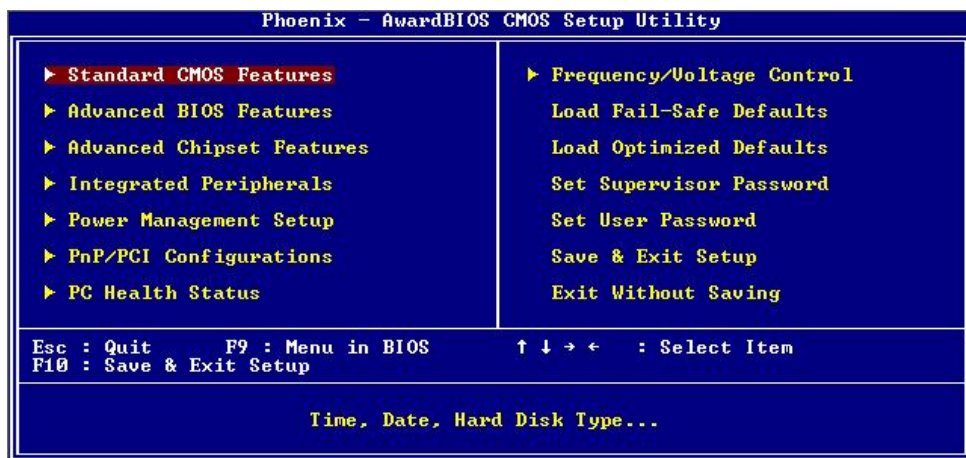

**(This Page is Left for Blank)**

## Appendix A <I/O Port Pin Assignment>

### A.1 < IDE Port >

Connector: IDE

Type: 44-pin (22 x 2) box header



Pin	Description	Pin	Description
1	Reset	2	Ground
3	D7	4	D8
5	D6	6	D9
7	D5	8	D10
9	D4	10	D11
11	D3	12	D12
13	D2	14	D13
15	D1	16	D14
17	D0	18	D15
19	Ground	20	N/C
21	REQ	22	Ground
23	IOW-/STOP	24	Ground
25	IOR-/HDMARDY	26	Ground
27	IORDY/DDMARDY	28	Ground
29	DACK-	30	Ground
31	IRQ	32	N/C
33	A1	34	SD
35	A0	36	A2
37	CS1	38	CS3
39	ASP1	40	Ground
41	Vcc	42	Vcc
43	Ground	44	Ground

### A.2 < Serial ATA Port >

Connector: S\_ATA1/2/3

Type: 7-pin wafer connector

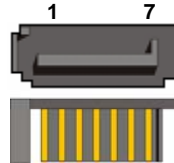

1	2	3	4	5	6	7
GND	RSATA_TXP1	RSATA_TXN1	GND	RSATA_RXN1	RSATA_RXP1	GND



### A.3 < IrDA Port >

Connector: **CN\_IR**

Type: 5-pin header for SIR Ports



Pin	Description
1	VCC
2	N/C
3	IRRX
4	Ground
5	IRTX

### A.4 < GPIO Port >

Connector: **CN\_DIO**

Type: onboard 2 x 6-pin header, pitch=2.0mm



Pin	Description	Pin	Description
1	Ground	2	Ground
3	GP10	4	GP14
5	GP11	6	GP15
7	GP12	8	GP16
9	GP13	10	GP17
11	VCC	12	+12V

### A.5 < USB Interface >

Connector: **CN\_USB1/2**

Type: 10-pin (5 x 2) header for dual USB Ports



Pin	Description	Pin	Description
1	VCC	2	VCC
3	Data0-	4	Data1-
5	Data0+	6	Data1+
7	Ground	8	Ground
9	Ground	10	N/C

## A.6 < Serial Port >

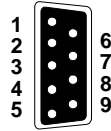







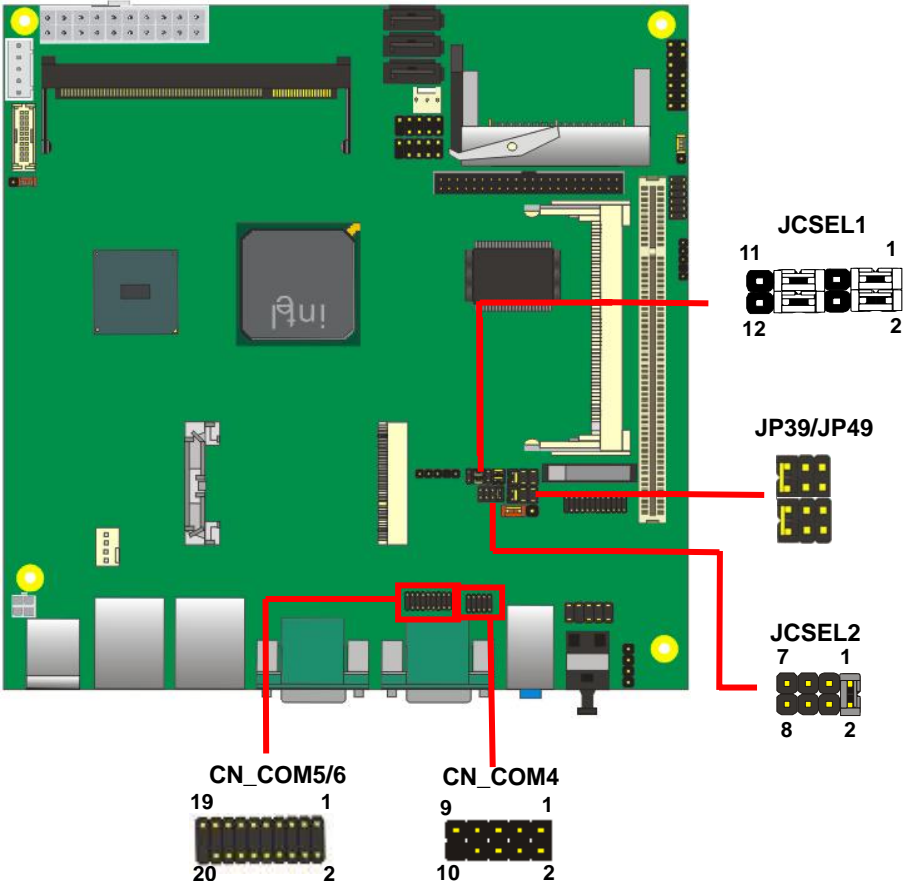

Connector: **COM1/2/3**

Type: 9-pin D-sub male connector on bracket

Pin	Description	Pin	Description
1	DCD/422TX-/485-	2	RXD/422TX+/485+
3	TXD/422RX+	4	DTR/422RX-
5	GND	6	DSR
7	RTS	8	CTS
9	RI	10	N/C

### Setting RS-232 & RS-422 & RS-485 for COM2



Function	JCSEL2	JCSEL1
IrDA		
RS-422		
RS-485		
RS-232		

Default setting:

JCSEL1: (1-3, 2-4, 7-9, 8-10) JCSEL2: (1-2)

Jumper: **JP39/JP49 (COM3/4)**

Type: onboard 6-pin header

Power Mode	JP39/JP49
Pin 9 with 5V Power	1-2
Pin 9 with 12V Power	3-4
<b>Default setting: 5-6</b>	

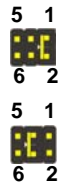

Connector: **CN\_COM4**

Type: 10-pin (5 x 2) header



Pin	Description	Pin	Description
1	DCD	2	RXD
3	TXD	4	DTR
5	GND	6	DSR
7	RTS	8	CTS
9	RI	10	N/C

Connector: **CN\_COM5/6**

Type: 20-pin (10x2) header

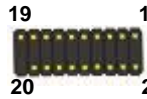

Pin	Description	Pin	Description
1	MDCD1	2	MSIN1
3	MSO1	4	MDTR1
5	GND	6	MDSR1
7	MRTS1	8	MCTS1
9	MRI1	10	NC
11	MDCD2	12	MSIN2
13	MSO2	14	MDTR2
15	GND	16	MDSR2
17	MRTS2	18	MCTS2
19	MRI2	20	NC

## A.7 < Parallel Port >

Connector: **CN\_LPT**

Type: 26-Pin box header Connector on bracket



Pin	Assignment	Pin	Assignment
1	-PSTB	14	AFD-
2	PRO0	15	ERR-
3	PRO1	16	INT-
4	PRO2	17	SLIN-
5	PRO3	18	Ground
6	PRO4	19	Ground
7	PRO5	20	I/O Ground
8	PRO6	21	Ground
9	PRO7	22	Ground
10	ACK-	23	Ground
11	BUSY	24	Ground
12	PE	25	Ground
13	SLCT	26	N/C

## A.8 < VGA Port >

Connector: **CRT1**

Type: 15-pin D-sub female connector on bracket

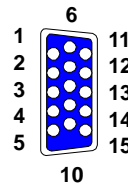

Pin	Description	Pin	Description	Pin	Description
1	RED	6	Ground	11	N/C
2	GREEN	7	Ground	12	DDC_DA
3	BLUE	8	Ground	13	HSYNC
4	N/C	9	+5V	14	VSYNC
5	Ground	10	Ground	15	DDC_CLK

## A.9 < LAN Port >

Connector: RJ45\_1/2

Type: RJ45 connector with LED on rear panel

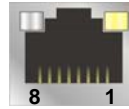

Pin	1	2	3	4	5	6	7	8
Description	TRD0+	TRD0-	TRD1+	TRD2+	TRD2-	TRD1-	TRD3+	TRD3-

## A.10 < SMBus >

Connector: CN\_SMBUS

Type: 4-pin SMBus connector





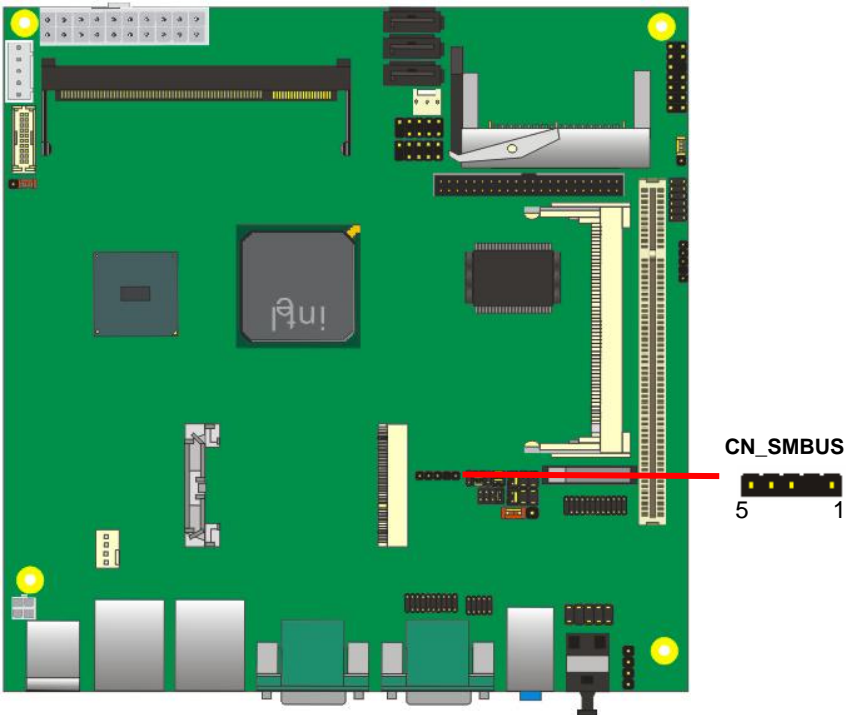















































Pin	Description	Pin	Description
1	VCC	2	N/C
3	SMBDATA	4	SMBCLK
5	Ground		



## Appendix B <System Resources>







































### B.1 < I/O Port Address Map >

	[00000000 - 00000CF7] PCI bus
	[00000000 - 0000000F] Direct memory access controller
	[00000010 - 0000001F] Motherboard resources
	[00000020 - 00000021] Programmable interrupt controller
	[00000022 - 0000003F] Motherboard resources
	[00000040 - 00000043] System timer
	[00000044 - 0000005F] Motherboard resources
	[00000060 - 00000060] Standard 101/102-Key or Microsoft Natural PS/2 Keyboard
	[00000061 - 00000061] System speaker
	[00000062 - 00000063] Motherboard resources
	[00000064 - 00000064] Standard 101/102-Key or Microsoft Natural PS/2 Keyboard
	[00000065 - 0000006F] Motherboard resources
	[00000070 - 00000073] System CMOS/real time clock
	[00000074 - 0000007F] Motherboard resources
	[00000080 - 00000090] Direct memory access controller
	[00000091 - 00000093] Motherboard resources
	[00000094 - 0000009F] Direct memory access controller
	[000000A0 - 000000A1] Programmable interrupt controller
	[000000A2 - 000000BF] Motherboard resources
	[000000C0 - 000000DF] Direct memory access controller
	[000000E0 - 000000EF] Motherboard resources
	[000000F0 - 000000FF] Numeric data processor
	[000001F0 - 000001F7] Primary IDE Channel
	[00000274 - 00000277] ISAPNP Read Data Port
	[00000279 - 00000279] ISAPNP Read Data Port
	[00000280 - 00000287] Communications Port (COM5)
	[00000288 - 0000028F] Communications Port (COM6)
	[000002A0 - 000002A7] Communications Port (COM3)
	[000002A8 - 000002AF] Communications Port (COM4)
	[000002F8 - 000002FF] Communications Port (COM2)
	[00000378 - 0000037F] Printer Port (LPT1)
	[00000380 - 000003BB] Intel(R) Graphics Media Accelerator 3150
	[000003C0 - 000003DF] Intel(R) Graphics Media Accelerator 3150
	[000003F6 - 000003F6] Primary IDE Channel
	[000003F8 - 000003FF] Communications Port (COM1)
	[00000400 - 000004BF] Motherboard resources

	[000004D0 - 000004D1] Motherboard resources
	[00000500 - 0000051F] Intel(R) ICH8 Family SMBus Controller - 283E
	[00000778 - 0000077B] Printer Port (LPT1)
	[00000880 - 0000088F] Motherboard resources
	[00000A79 - 00000A79] ISAPNP Read Data Port
	[00000D00 - 0000FFFF] PCI bus
	[0000C000 - 0000CFFF] Intel(R) ICH8 Family PCI Express Root Port 1 - 283F
	[0000CF00 - 0000CF1F] Intel(R) 82583V Gigabit Network Connection
	[0000D000 - 0000DFFF] Intel(R) ICH8 Family PCI Express Root Port 2 - 2841
	[0000DF00 - 0000DF1F] Intel(R) 82583V Gigabit Network Connection #2
	[0000F300 - 0000F30F] Intel(R) ICH8M 3 port Serial ATA Storage Controller - 2828
	[0000F400 - 0000F40F] Intel(R) ICH8M 3 port Serial ATA Storage Controller - 2828
	[0000F500 - 0000F503] Intel(R) ICH8M 3 port Serial ATA Storage Controller - 2828
	[0000F600 - 0000F607] Intel(R) ICH8M 3 port Serial ATA Storage Controller - 2828
	[0000F700 - 0000F703] Intel(R) ICH8M 3 port Serial ATA Storage Controller - 2828
	[0000F800 - 0000F807] Intel(R) ICH8M 3 port Serial ATA Storage Controller - 2828
	[0000F900 - 0000F90F] Intel(R) ICH8M Ultra ATA Storage Controllers - 2850
	[0000FA00 - 0000FA1F] Intel(R) ICH8 Family USB Universal Host Controller - 2832
	[0000FB00 - 0000FB1F] Intel(R) ICH8 Family USB Universal Host Controller - 2831
	[0000FC00 - 0000FC1F] Intel(R) ICH8 Family USB Universal Host Controller - 2830
	[0000FD00 - 0000FD1F] Intel(R) ICH8 Family USB Universal Host Controller - 2835
	[0000FE00 - 0000FE1F] Intel(R) ICH8 Family USB Universal Host Controller - 2834
	[0000FF00 - 0000FF07] Intel(R) Graphics Media Accelerator 3150



## B.2 < Memory Address Map >

	[00000000 - 0009FFFF] System board
	[000A0000 - 000BFFFF] PCI bus
	[000A0000 - 000BFFFF] Intel(R) Graphics Media Accelerator 3150
	[000C0000 - 000DFFFF] PCI bus
	[000E0000 - 000EFFFF] System board
	[000F0000 - 000FFFFFF] System board
	[00100000 - 7F58FFFF] System board
	[7F590000 - 7F5FFFFFF] System board
	[7F600000 - 7F6FFFFFF] System board
	[7F700000 - FEBFFFFFF] PCI bus
	[D0000000 - DFFFFFFF] Intel(R) Graphics Media Accelerator 3150
	[E0000000 - EFFFFFFF] Motherboard resources
	[FD700000 - FD7FFFFFF] Intel(R) ICH8 Family PCI Express Root Port 1 - 283F
	[FD800000 - FD8FFFFFF] Intel(R) ICH8 Family PCI Express Root Port 1 - 283F
	 [FD8C0000 - FD8DFFFF] Intel(R) 82583V Gigabit Network Connection
	 [FD8FC000 - FD8FFFFFF] Intel(R) 82583V Gigabit Network Connection
	[FDB00000 - FDBFFFFFF] Intel(R) Graphics Media Accelerator 3150
	[FDC00000 - FDCFFFFFF] Intel(R) ICH8 Family PCI Express Root Port 2 - 2841
	[FDD00000 - FDDFFFFFF] Intel(R) ICH8 Family PCI Express Root Port 2 - 2841
	 [FDDC0000 - FDDDFFFF] Intel(R) 82583V Gigabit Network Connection #2
	 [FDDFC000 - FDDFFFFFF] Intel(R) 82583V Gigabit Network Connection #2
	[FDE80000 - FDEFFFFFF] Intel(R) Graphics Media Accelerator 3150
	[FDFF8000 - FDFFBFFF] Microsoft UAA Bus Driver for High Definition Audio
	[FDFFD000 - FDFFD0FF] Intel(R) ICH8 Family SMBus Controller - 283E
	[FDFFE000 - FDFFE3FF] Intel(R) ICH8 Family USB2 Enhanced Host Controller - 2836
	[FDFFF000 - FDFFF3FF] Intel(R) ICH8 Family USB2 Enhanced Host Controller - 283A
	[FEB80000 - FEBFFFFFF] Intel(R) Graphics Media Accelerator 3150
	[FEC00000 - FEC00FFF] System board
	[FED00000 - FED003FF] High precision event timer
	[FED00000 - FED000FF] System board
	[FED13000 - FED1FFFF] System board
	[FED20000 - FED9FFFF] System board
	[FEE00000 - FEE00FFF] System board
	[FFB00000 - FFB7FFFF] System board
	[FFB80000 - FFBFFFFFF] Intel(R) 82802 Firmware Hub Device
	[FFF00000 - FFFFFFFF] System board

### B.3 < System IRQ Resources >

	(ISA) 0	High precision event timer
	(ISA) 1	Standard 101/102-Key or Microsoft Natural PS/2 Keyboard
	(ISA) 3	Communications Port (COM2)
	(ISA) 4	Communications Port (COM1)
	(ISA) 5	Communications Port (COM3)
	(ISA) 7	Communications Port (COM4)
	(ISA) 8	High precision event timer
	(ISA) 9	Microsoft ACPI-Compliant System
	(ISA) 10	Communications Port (COM5)
	(ISA) 11	Communications Port (COM6)
	(ISA) 13	Numeric data processor
	(ISA) 14	Primary IDE Channel
	(PCI) 15	Intel(R) ICH8 Family SMBus Controller - 283E
	(PCI) 16	Intel(R) 82583V Gigabit Network Connection
	(PCI) 16	Intel(R) Graphics Media Accelerator 3150
	(PCI) 16	Intel(R) ICH8 Family PCI Express Root Port 1 - 283F
	(PCI) 16	Intel(R) ICH8 Family USB Universal Host Controller - 2834
	(PCI) 17	Intel(R) 82583V Gigabit Network Connection #2
	(PCI) 17	Intel(R) ICH8 Family PCI Express Root Port 2 - 2841
	(PCI) 18	Intel(R) ICH8 Family USB Universal Host Controller - 2832
	(PCI) 18	Intel(R) ICH8 Family USB2 Enhanced Host Controller - 283A
	(PCI) 19	Intel(R) ICH8 Family USB Universal Host Controller - 2831
	(PCI) 19	Intel(R) ICH8M 3 port Serial ATA Storage Controller - 2828
	(PCI) 21	Intel(R) ICH8 Family USB Universal Host Controller - 2835
	(PCI) 22	Microsoft UAA Bus Driver for High Definition Audio
	(PCI) 23	Intel(R) ICH8 Family USB Universal Host Controller - 2830
	(PCI) 23	Intel(R) ICH8 Family USB2 Enhanced Host Controller - 2836

### B.4 < System DMA Resources >

	4	Direct memory access controller
--	---	---------------------------------

## Appendix C <Flash BIOS>

### C.1 <BIOS Auto Flash Tool>

The board is based on Award BIOS and can be updated easily by the BIOS auto flash tool. You can download the tool online at the address below:

<http://www.award.com>

<http://www.commell.com.tw/support/support.htm>

File name of the tool is "awdf flash.exe", it's the utility that can write the data into the BIOS flash ship and update the BIOS.

### C.2 <Flash Method>

1. Please make a bootable floppy disk.
2. Get the last .bin files you want to update and copy it into the disk.
3. Copy awardflash.exe to the disk.
4. Power on the system and flash the BIOS. (Example: C:/ awardflash XXX.bin)
5. Re-star the system.

Any question about the BIOS re-flash please contact your distributors or visit the web-site at below:

<http://www.commell.com.tw/support/support.htm>

## Appendix D <Programming GPIO's>

The GPIO can be programmed with the MSDOS debug program using simple IN/OUT commands. The following lines show an example how to do this.

GPIO0.....GPIO7 bit0.....bit7

```
-o 2E 87 ;enter configuration
-o 2E 87
-o 2E 07
-o 2F 09 ;enable GPIO function
-o 2E 30
-o 2F 02 ;enable GPIO configuration
-o 2E F0
-o 2F xx ;set GPIO as input/output; set '1' for input,'0'for output
-o 2E F1
-o 2F xx ;if set GPIO's as output,in this register its value can be set
```

Optional :

```
-o 2E F2
-o 2F xx ; Data inversion register ; '1' inverts the current value of the bits , '0'
leaves them as they are
-o 2E 30
-o 2F 01 ; active GPIO's
```

For further information ,please refer to Winbond W83627DHG-P datasheet.

## Appendix E <Watch Dog timer Setting >

The watchdog timer makes the system auto-reset while it stops to work for a period. The integrated watchdog timer can be setup as system reset mode by program.

### Timeout Value Range

- 1 to 255
- Second or Minute

### Program Sample

Watchdog timer setup as system reset with 5 second of timeout

```

2E, 87
2E, 87
2E, 07
2F, 08      Logical Device 8
2E, 30      Activate
2F, 01
2E, F5      Set as Second*
2F, 00
2E, F6      Set as 5
2F, 05
    
```

\* Minute: bit 3 = 0; Second: bit 3 = 1

You can select Timer setting in the BIOS, after setting the time options, the system will reset according to the period of your selection.

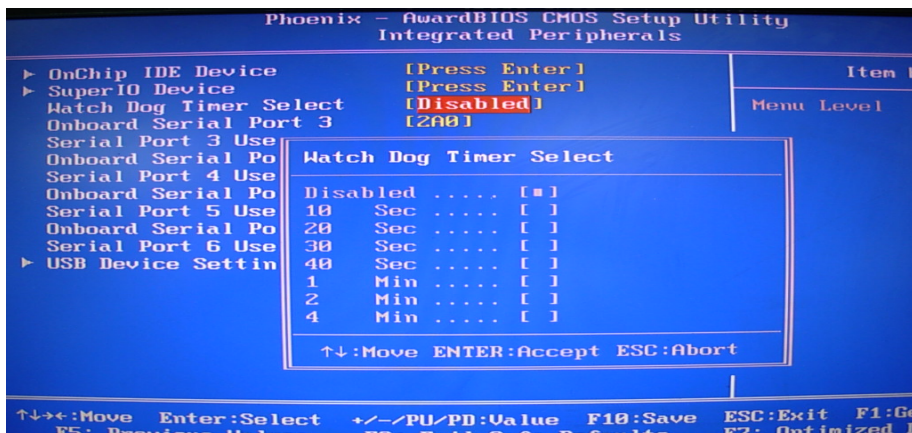

## Contact Information

Any advice or comment about our products and service, or anything we can help you please don't hesitate to contact with us. We will do our best to support you for your products, projects and business.

### Taiwan Commate Computer Inc.

Address	19F., No.94, Sec. 1, Xintai 5th Rd., Xizhi Dist., New Taipei City 22102, Taiwan
TEL	+886-2-26963909
FAX	+886-2-26963911
Website	<a href="http://www.commell.com.tw">http://www.commell.com.tw</a>
E-Mail	<a href="mailto:info@commell.com.tw">info@commell.com.tw</a> (General Information) <a href="mailto:tech@commell.com.tw">tech@commell.com.tw</a> (Technical Support)
Facebook	<a href="https://www.facebook.com/pages/Taiwan-Commate-Computer-Inc/54799395271899">https://www.facebook.com/pages/Taiwan-Commate-Computer-Inc/54799395271899</a>
Twitter	<a href="https://twitter.com/Taiwan_Commamate">https://twitter.com/Taiwan_Commamate</a>

**Commell is a brand name of Taiwan commate computer Inc.**