

LV-67R

Mini-ITX Mobile Motherboard

User's Manual

Edition 3.2
2021/11/29

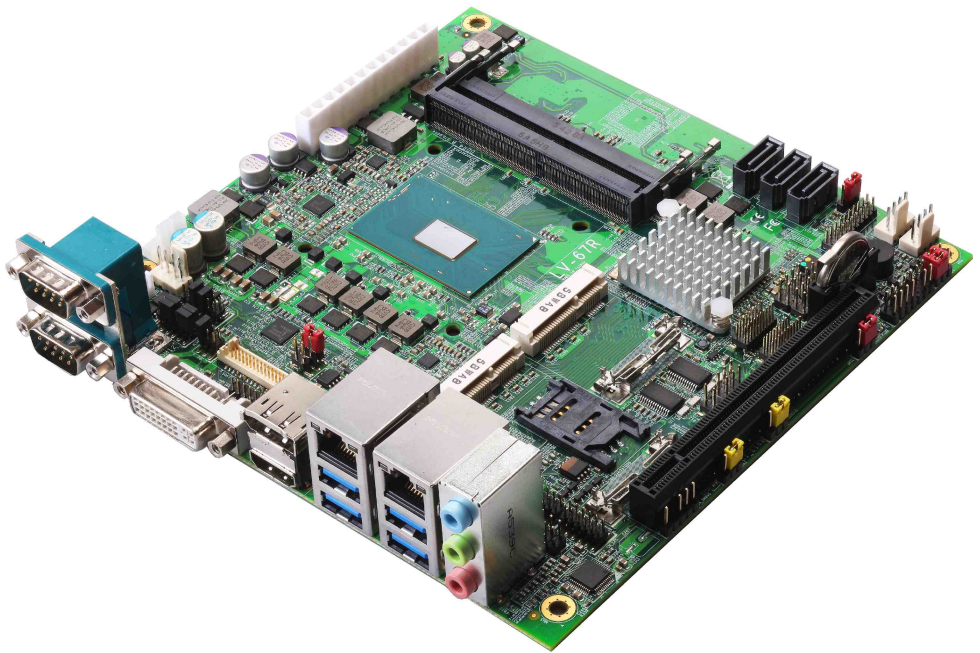

Copyright

Copyright 2021, all rights reserved. This document is copyrighted and all rights are reserved. The information in this document is subject to change without prior notice to make improvements to the products.

This document contains proprietary information and protected by copyright. No part of this document may be reproduced, copied, or translated in any form or any means without prior written permission of the manufacturer.

All trademarks and/or registered trademarks contains in this document are property of their respective owners.

Disclaimer

The company shall not be liable for any incidental or consequential damages resulting from the performance or use of this product.

The company does not issue a warranty of any kind, express or implied, including without limitation implied warranties of merchantability or fitness for a particular purpose.

The company has the right to revise the manual or include changes in the specifications of the product described within it at any time without notice and without obligation to notify any person of such revision or changes.

Trademark

All trademarks are the property of their respective holders.

Any questions please visit our website at <http://www.commell.com.tw>

Packing List:

Please check the package content before you starting using the board.

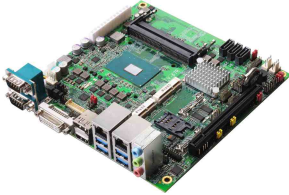

1 x LV-67R Mini-ITX Motherboard
(include Cooler Fan)



1 x VGA Cable
(OALVGA-SNB-7) / (1040557)



2 x SATA Cable
(OALSATA3-L) / (1040529)

OPTIONAL:



1 x Audio cable
(OALPJ-HD) / (1040120)



1 x Dual COM PORT Cable
(OALES-BKU2) / (1040087)

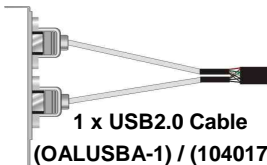

1 x USB2.0 Cable
(OALUSBA-1) / (1040172)

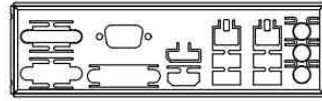

1 x I/O Shield
(OPLATE-CDILAT) / (1270067)

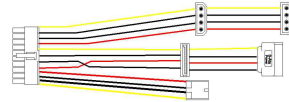

1 x Power Cable
(OALATX-P3S2 / 1040058)



1 x DC Power Cable
(OALDC-A) / (1040433)

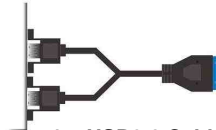

1 x USB3.0 Cable
(OALUSB3) / (1040531)

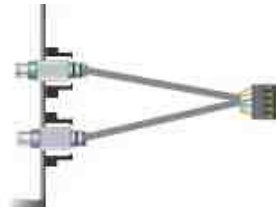

1 x PS/2 Keyboard & Mouse cable
(OALPS2/KMB) / (1040610)

Printed Matters:

Driver CD (Including User's Manual) x 1

Index

Chapter 1 <Introduction>	4
1.1 <Product Overview>	4
1.2 <Product Specification>	5
1.3 <Mechanical Drawing>	6
1.4 <Block Diagram>	7
Chapter 2 <Hardware setup>	8
2.1 <Connector Location and Reference>	8
2.1.1 <Internal connectors list>	9
2.1.2 <External connectors list>	9
2.2 <Memory Setup>	10
2.3 <Jumper Location and Reference>	11
2.3.1 <Jumper list>	11
2.3.2 <Clear CMOS and Power on type selection>	12
2.4 <I/O interface>	12
2.4.1 <Serial ATA interface>	12
2.4.2 <Ethernet interface>	13
2.4.3 <Display interface>	13
2.4.4 <Serial Port interface>	15
2.4.5 <USB interface>	18
2.4.6 <Audio interface>	20
2.4.7 <Expansion slot>	21
2.4.8 <Front panel switch and indicator>	22
2.4.9 <GPIO and Other interface>	23
2.5 <Power supply>	25
2.5.1 <Power input>	25
2.5.1 <Power Output>	26
Appendix A <Flash BIOS>	27
Appendix B <LCD Panel Type select>	28
Appendix C <Programmable Watch Dog Timer>	29
Appendix D <Hardware monitor >	31
Appendix E <Programmable GPIO >	32
Appendix F <RAID Setting>	33
Appendix G <Setup ADP-3355,ADP-3460>	35
Appendix H <SuperIO Setting>	35
Contact information	37

Chapter 1 <Introduction>

1.1 <Product Overview>

LV-67R is Mini-ITX Motherboard which supports Intel® 6th / 7th Gen Intel® Core™/ Xeon® H-series Processor with Intel® QM170 /QM175 /CM238 Chipset, integrated HD Graphics 530, DDR4 memory, Realtek High Definition Audio, Intel Gigabit LAN, Serial ATA3

The 6th / 7th Generation Intel® Core™ H-series processor family is new generation and multi-core processor built on 14 nanometer process.

Skylake provide new HD Graphics 530/630 support triple displays at the same time, maximum supported is up to 32GB of DDR4, better performance, flexibility and more enhanced security that is suitable for a variety of intelligent systems the ideal choice.

All in One multimedia solution

LV-67R provides high performance onboard graphics, 18/24-bit single/dual channel LVDS interface, DisplayPort, HDMI, DVI-I, VGA and High Definition Audio, to meet the requirement of the multimedia application.

Flexible Expansion Interface

It includes two minicard slot, PCIeX16 slot, 6 COM port, 6 USB3.0, and 4 USB2.0.

Skylake remove EHCI, all USB ports are xHCI

When you install Windows7 with USB device(CDROM, Keyboard, Mouse...), Windows7 can not identify your usb device. You can use SATA CD-ROM and *PS/2 to install Windows7.

**PS/2 cable is optional.*

Kaby Lake only support Windows10 64bit

Intel only support Windows 10 64bit. It may lose some drivers if you use other Windows version.

1.2 <Product Specification>

System

Processor	Intel® 6th / 7th Gen Intel® Core™/ Xeon® H-series Processor, FCBGA1440 package
Chipset	Intel® QM170 /QM175 /CM238
Memory	2 x DDR4 SO-DIMM 2133 MHz up to 32GB, Support Non-ECC, unbuffered memory only
Watchdog Timer	Generates a system reset with internal timer for 1min/s ~ 255min/s
Real Time Clock	Chipset integrated RTC with onboard lithium battery
Expansion	1 x Half Size MiniPCie 1 x MiniPCle (support mSATA) 1 x Sim slot 1 x PCIe X16 slot (Use ATX power when you install a graphics card).

Graphics

Chipset	Intel® 9th Gen integrated HD Graphics
Display Interface	1 x DVI-I, 1 x DisplayPort(optional) 1 x LVDS, 1 x HDMI, 1 x VGA

LAN

Chip	1 x Intel® I219-LM Gigabit PHY LAN (support iAMT 11.0) 1 x Intel® I210-AT Gigabit LAN
------	--

I/O

Serial ATA	3 x SATA3
Audio	Realtek ALC262 HD Audio
Internal I/O	3 x SATA3, 4 x RS232, 4 x USB2.0, 2 x USB3.0, 1 x LVDS, 1 x LPC 1 x LCD inverter, 1 x GPIO , 1 x Audio, 1 x PS/2, 1 x SMBUS, 1 x VGA
Rear I/O	1 x DisplayPort(optional), 1 x DVI-I, 1 x HDMI, 4 x USB3.0, 2 x LAN, 1 x RS232/422/485, 1 x RS232, 1 x Audio.

Mechanical & Environmental

Power Requirement	Standard 24-pin ATX power supply or 4-pin 9~25V (Without LVDS, 60W) Note that do not use at the same time
Size	170mm x 170mm (L x W)
Temperature	Operating within 0°C~60°C (32°F~140°F) Storage within -20°C~80°C (-4°F~176°F)
Relative Humidity	10%~90%, non-condensing

1.3 <Mechanical Drawing>

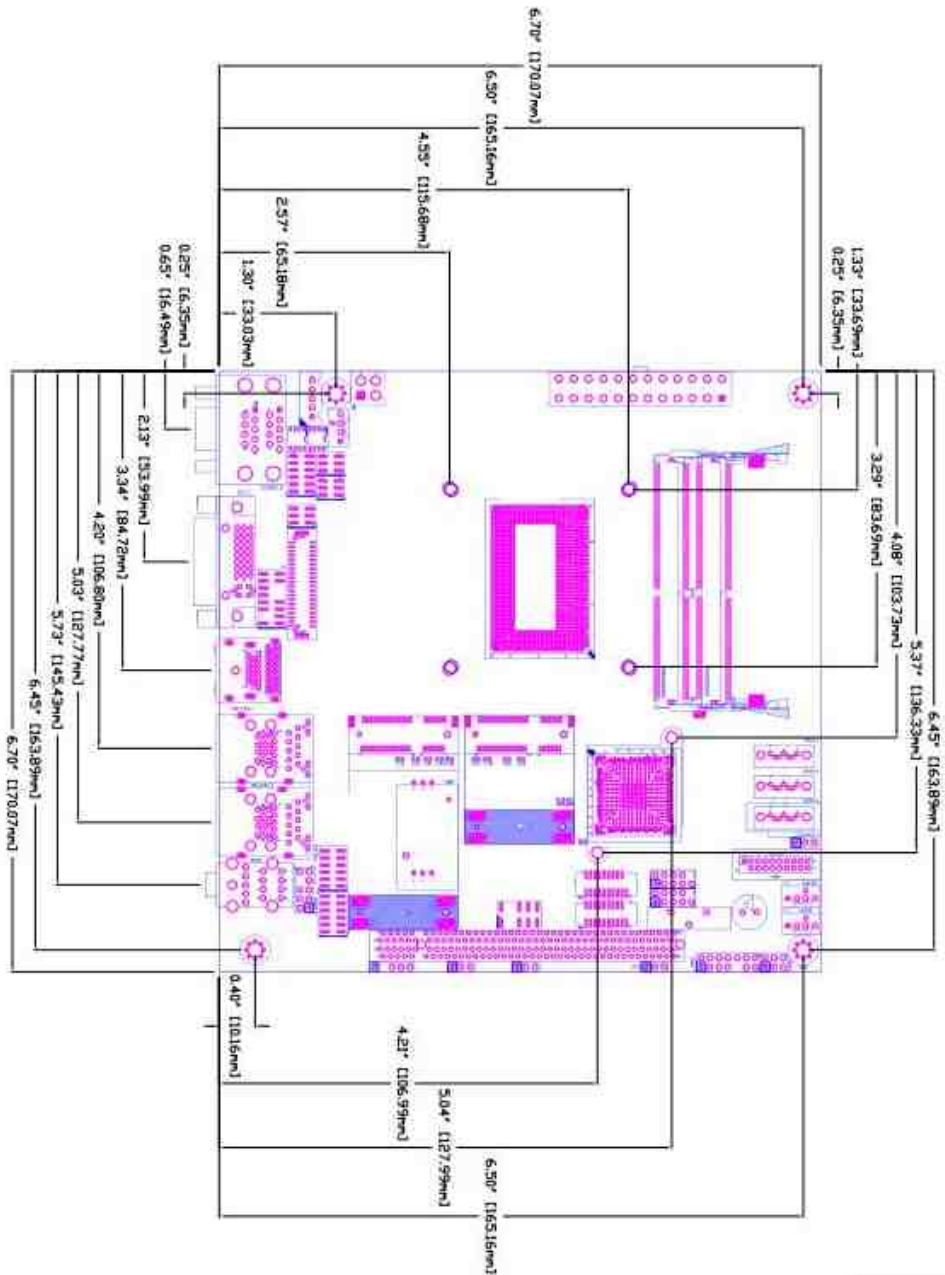

1.4 <Block Diagram>

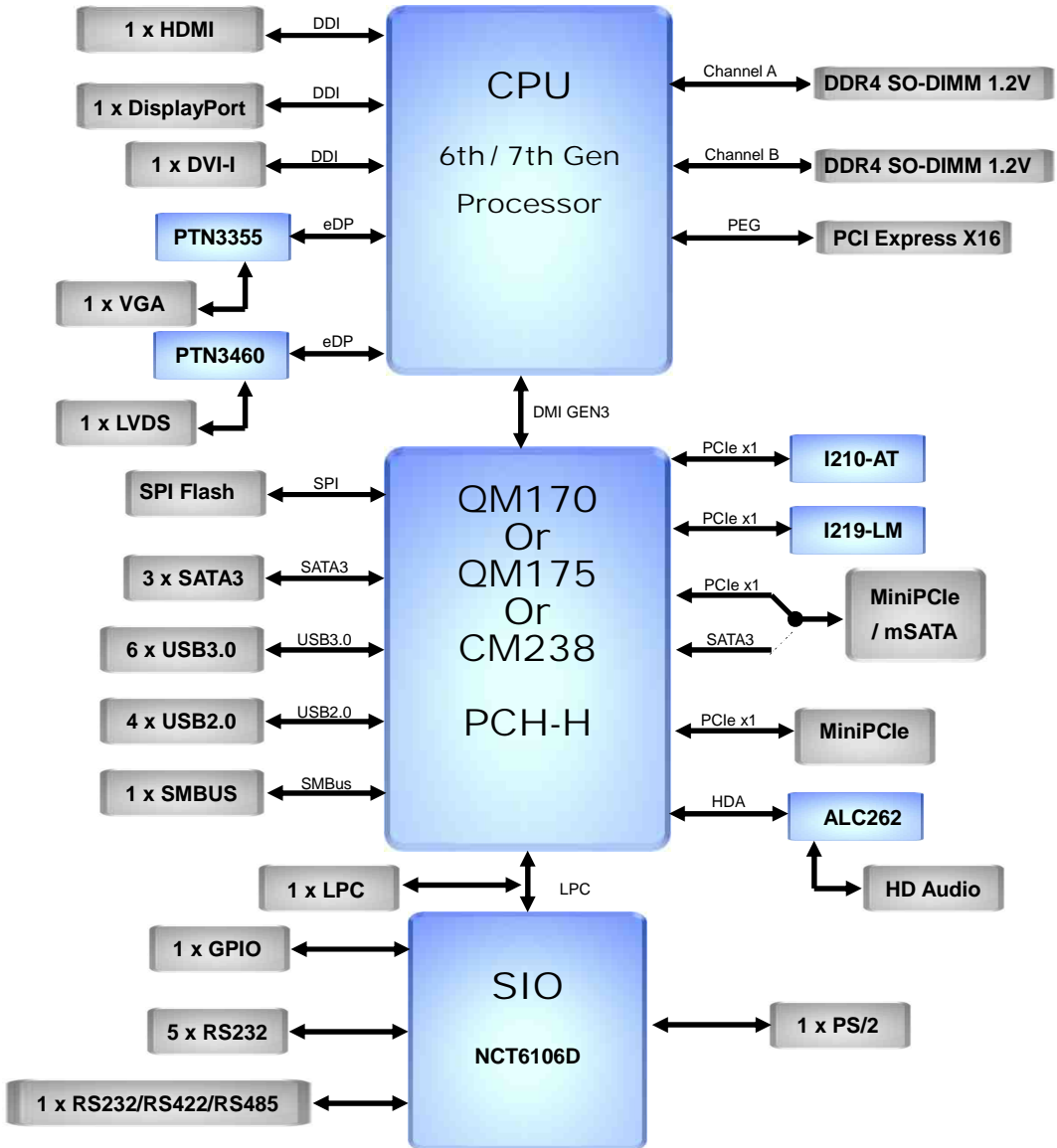

Chapter 2 <Hardware setup>

2.1 <Connector Location and Reference>

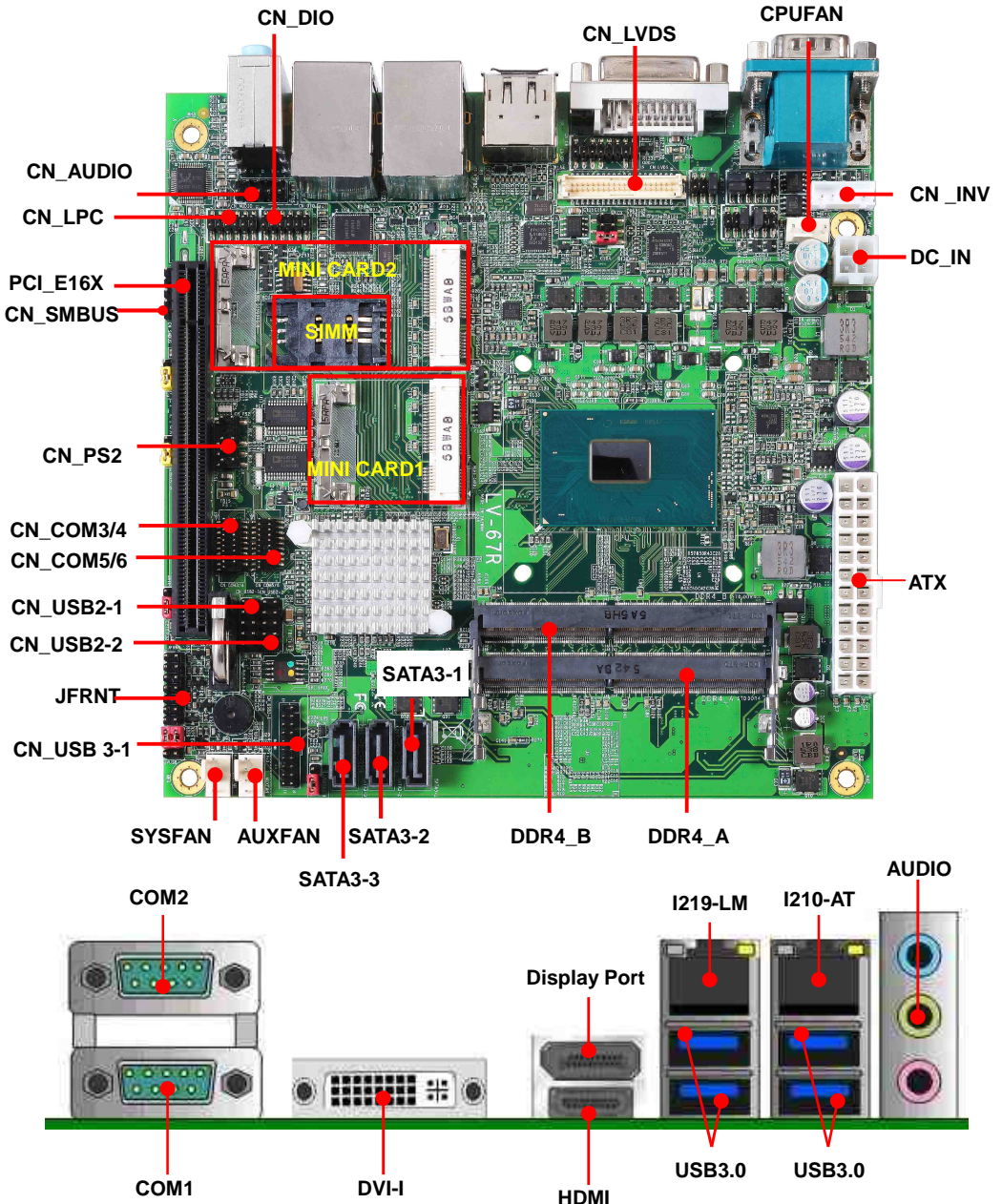

2.1.1 <Internal connectors list>

Connector	Function
DDR4_A/B	260-pin DDR4 SO-DIMM slot
SATA3-1/2/3	7-pin Serial ATA3 connector
CN_AUDIO	5 x 2-pin audio pin header
CN_LPC	6 x 2-pin LPC pin header
CN_LVDS	20 x 2-pin LVDS connector
CN_INV	5-pin LCD inverter connector
CN_SMBUS	5-pin SMBus connector
CN_COM 3/4/5/6	20-pin RS232 connector
CN_USB 2-1/2-2	5 x 2-pin USB2.0 pin header
CN_USB 3-1	10 x 2-pin USB3.0 pin header
CN_PS2	5 x 2-pin PS/2 pin header
CN_DIO	6 x 2-pin digital I/O connector
CN_CRT	16-pin VGA connector
CPUFAN	4-pin CPU fan connector
SYSFAN	4-pin system fan connector
AUXFAN	4-pin system fan connector
JFRNT	14-pin front panel switch/indicator connector
PCI_E16X	164-pin x16 PCIE slot
MINI_CARD1	52-pin Half-MiniPCle card slot
MINI_CARD2	52-pin MiniPCle card slot
ATX	24-pin power supply connector
DC_IN	4-pin power input Terminal Block
SIMM	6-pin socket

2.1.2 <External connectors list>

Connector	Function
DisplayPort	DisplayPort connector
DVI-I	DVI connector
HDMI	HDMI connector
USB3.0	USB3.0 connector
LAN	RJ45 connector
AUDIO	Audio connector
COM1/2	DB9 Serial port connector

2.2 <Memory Setup>

In the process, the board must be powered off.

1. Put the memory tilt into the slot. Note the Memory notch key aligned slot key.
2. Then press down till lock into the mounting notch.

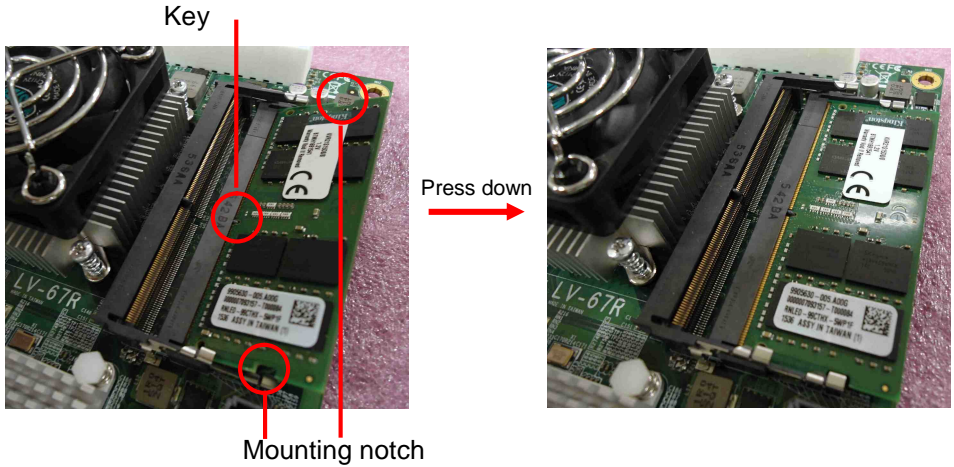

3. To remove the memory, push outward on both sides of the latch.

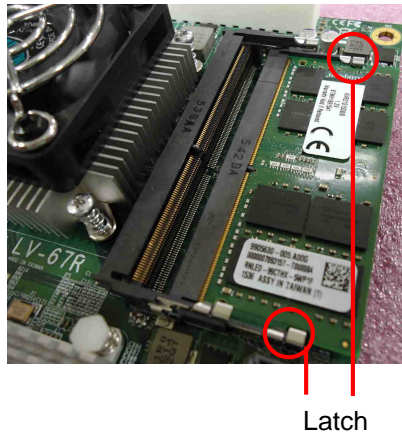

2.3 <Jumper Location and Reference>

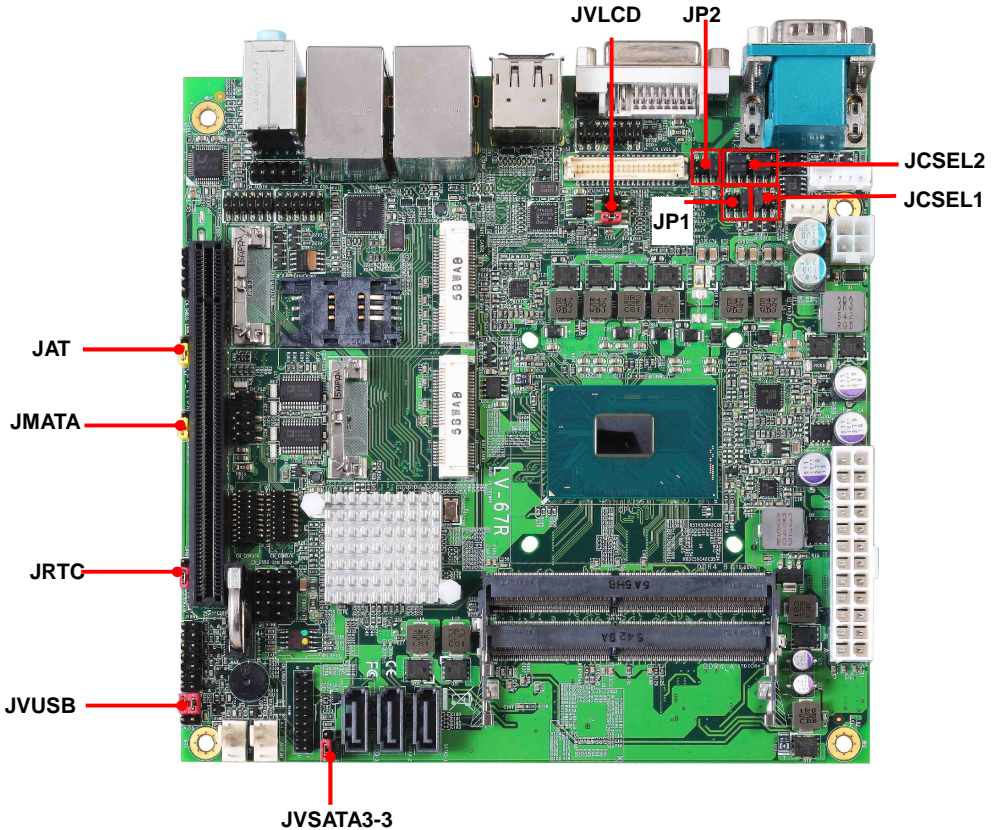

2.3.1 <Jumper list>

Jumper	Function
JAT	Power mode select
JRTC	CMOS Normal/Clear Setting
JVLCD	Panel Voltage Setting
JMSATA	MiniCard 2 MSATA Setting
JP1	COM1 Voltage Setting (For Pin 9)
JP2	COM2 Voltage Setting (For Pin 9)
JCSEL1	COM2 RS-232 RS422 RS485 Setting
JCSEL2	COM2 RS-232 RS422 RS485 Setting
JVSATA3-3	Set 5V to SATA3-3 pin 7 (For SATADOM)
JVUSB	USB Voltage Setting

2.3.2 <Clear CMOS and Power on type selection>

The board's data of CMOS can be setting in BIOS. If the board refuses to boot due to inappropriate CMOS settings, here is how to proceed to clear (reset) the CMOS to its default values.

JAT: AT/ATX mode select jumper

Jumper settings	Function
1-2	AT mode
2-3	ATX mode (Default)



JRTC: Clear CMOS data jumper

Jumper settings	Function
1-2	Clear CMOS
2-3	Normal (Default)



2.4 <I/O interface>

2.4.1 <Serial ATA interface>

SATA 1/2/3: SATA3 7-pin connector

Pin	Signal
1	GND
2	TX+
3	TX-
4	GND
5	RX-
6	RX+
7	GND

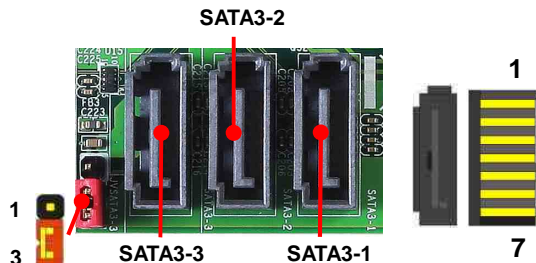

JVSATA3-3

JVSATA3-3: SATA3/SATA DOM mode select jumper

Jumper settings	Function
1-2	SATA3-3 SATA DOM (change pin7 to 5V)
2-3	SATA3-3 SATA3 (Default)

If you use SATA DOM, please check your SATA DOM Pin 7. Some device (like Innodisk) require power supply via Pin 7. If not, keep JVSATA3-3 jumper to default setting (2-3).

2.4.2 <Ethernet interface>

The board provide I219-LM PHY Gigabit Ethernet and I210-AT Gigabit Ethernet on rear I/O. Intel I219-LM and I210 supports operation at 10/100/1000 Mb/s data rates, with IEEE802.3 compliance and Wake-On-LAN supported. The I219-LM support Intel® AMT 11.0 feature, if want to use, need to enable in the BIOS

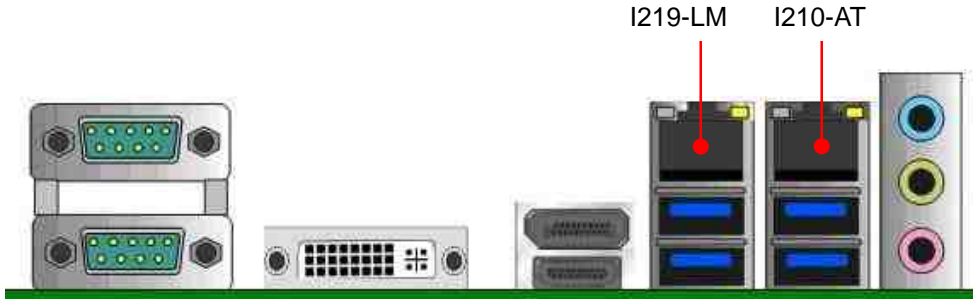

2.4.3 <Display interface>

Based on the 6th / 7th Gen CPU with built-in HD Graphics 530, VGA and DVI up to **1920x1080@60Hz**, DisplayPort up to **4096x2304@60Hz** , HDMI up to **4096x2304@24Hz** on rear IO. About the internal Display, LVDS (PTN3460) up to **1920x1200@60Hz** support 18/24-bit color depth and single/dual channel. About select LCD Panel Type in BIOS, please refer **Appendix B**.

The built-in HD Graphics support triple display function with clone mode and extended mode.

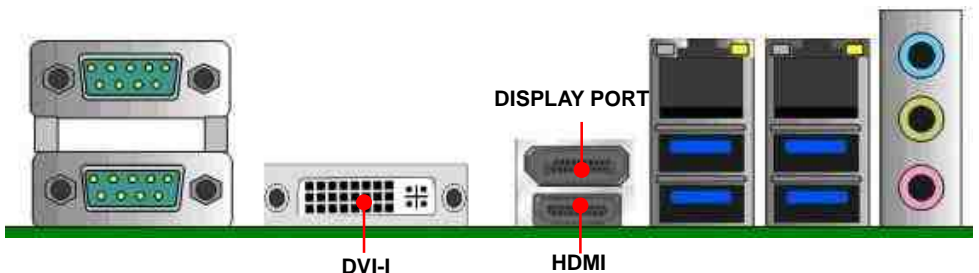

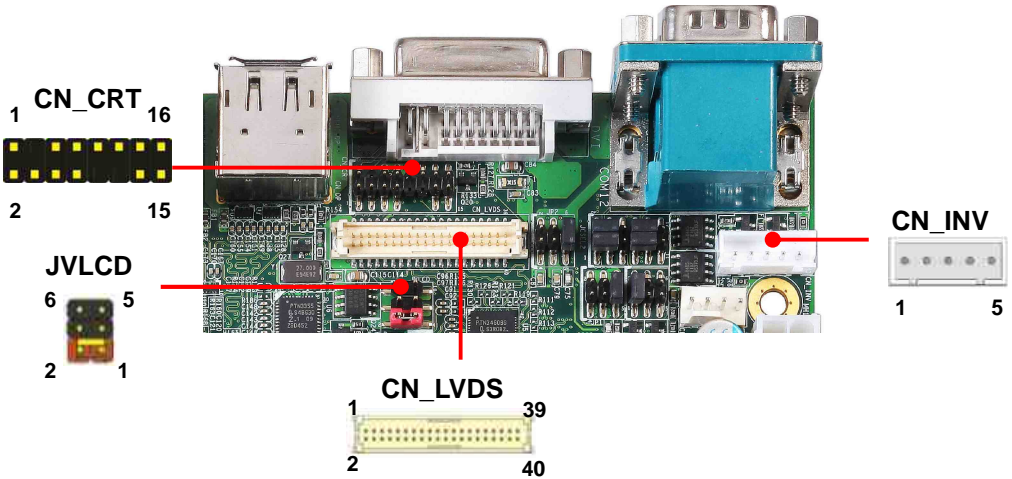
CN_CRT: VGA 16-pin connector (Pitch 2.00 mm)

Pin	Signal	Pin	Signal
1	BR	2	BG
3	BB	4	NC
5	IOGND1	6	IOGND1
7	IOGND1	8	IOGND1
9	NC	10	IOGND1
11	NC	12	5VCDA
13	5HSYNC	14	5VSYNC
15	5VCLK	16	NC

CN_LVDS: LVDS 40-pin connector (Model: HIROSE DF13-40DP-1.25V compatible)

Pin	Signal	Pin	Signal
2	Set by JVLCD	1	Set by JVLCD
4	Detect (Active low)	3	GND
6	A_LVDS_0-	5	B_LVDS_0-
8	A_LVDS_0+	7	B_LVDS_0+
10	GND	9	GND
12	A_LVDS_1-	11	B_LVDS_1-
14	A_LVDS_1+	13	B_LVDS_1+
16	GND	15	GND
18	A_LVDS_2-	17	B_LVDS_2-
20	A_LVDS_2+	19	B_LVDS_2+
22	GND	21	GND

24	A_LVDS_CLK-	23	B_LVDS_3-
26	A_LVDS_CLK+	25	B_LVDS_3+
28	GND	27	GND
30	A_LVDS_3-	29	B_LVDS_CLK-
32	A_LVDS_3+	31	B_LVDS_CLK+
34	GND	33	GND
36	LVDS_DDCSCL	35	NC
38	LVDS_DDCSDA	37	NC
40	NC	39	NC

Pin4 only need to be connected to GND

CN_INV: LVDS 5-pin Backlight power connector

Pin	Signal
1	12V
2	Backlight Control
3	GND
4	GND
5	Enable Backlight

JVLCD: LVDS panel power select jumper

Jumper settings	Function
1-2	3.3V (Default)
3-4	5V
5-6	12V

2.4.4 <Serial Port interface>

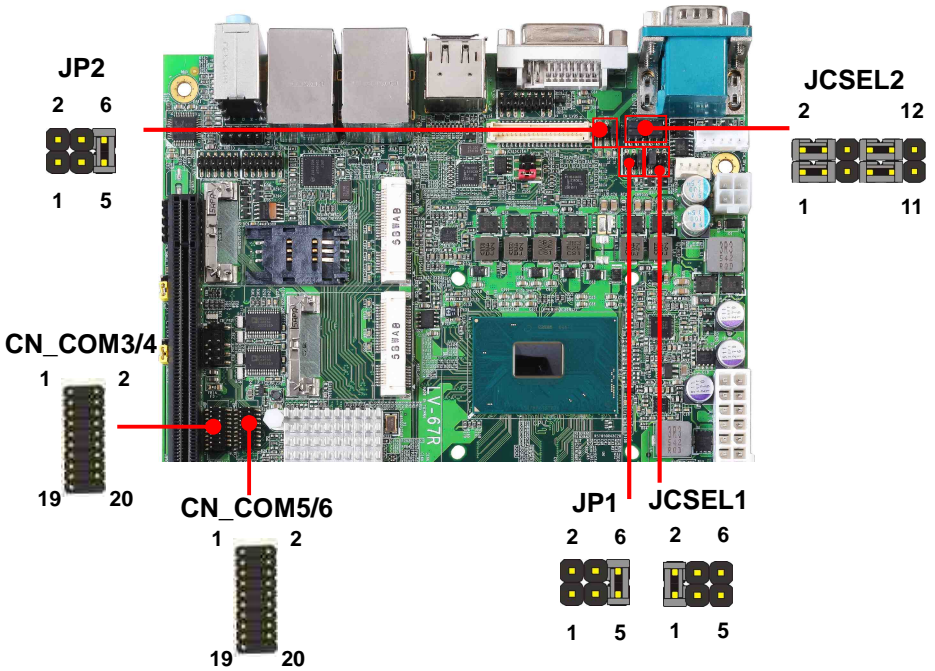

COM1: RS232 DB9 connector

Pin	Signal	Pin	Signal
1	DCD	2	RXD
3	TXD	4	DTR
5	GND	6	DSR
7	RTS	8	CTS
9	Set by JP1		

COM2: RS232/422/485 DB9 connector

Pin	Signal	Pin	Signal
1	DCD/ 422TX-/ 485-	2	RXD/ 422TX+/ 485+
3	TXD/ 422RX+	4	DTR/ 422RX-
5	GND	6	DSR
7	RTS	8	CTS
9	Set by JP2		

Use JCSEL1 and JCSEL2 to select communication mode

COM3/4: COM 20-pin header (Pitch 2.54 x 1.27mm)

Pin	Signal	Pin	Signal
1	DCD1	2	RXD1
3	TXD1	4	DTR1
5	GND	6	DSR1
7	RTS1	8	CTS1
9	RI1	10	NC
11	DCD2	12	RXD2
13	TXD2	14	DTR2
15	GND	16	DSR2
17	RTS2	18	CTS2
19	RI2	20	Key

COM5/6: COM 20-pin header (Pitch 2.54 x 1.27mm)

Pin	Signal	Pin	Signal
1	DCD1	2	RXD1
3	TXD1	4	DTR1
5	GND	6	DSR1
7	RTS1	8	CTS1
9	RI1	10	NC
11	DCD2	12	RXD2
13	TXD2	14	DTR2
15	GND	16	DSR2
17	RTS2	18	CTS2
19	RI2	20	Key

JP1, JP2: COM1, COM2 pin-9 setting

Jumper settings	Function
1-2	5V
3-4	12V
5-6	RI (Default)

Effective patterns of connection: 1-2 / 3-4 / 5-6

Other may cause damage

JCSEL1, JCSEL2: For configure COM2 communication mode

Function	JCSEL1	JCSEL2
RS232 (Default)		
RS485		
RS422		

2.4.5 <USB interface>

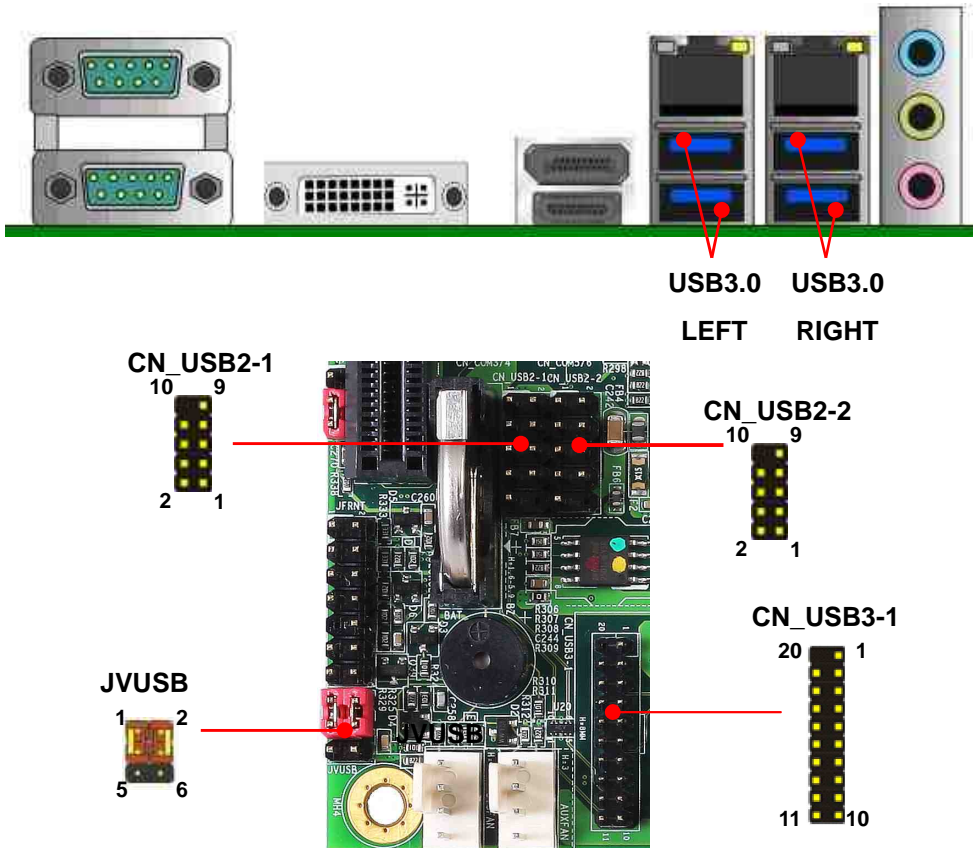

CN_USB 2-1/2-2: USB2.0 10-pin header

Pin	Signal	Pin	Signal
1	5VSB	2	5VSB
3	DATA0-	4	DATA1-
5	DATA0+	6	DATA1+
7	GND	8	GND
9	GND	10	Key

Install USB3.0 Driver if you want to use CN_USB 2-1/2-2 in Windows7.

CN_USB3-1: USB3.0 20-pin header (Pitch 2.00 mm)

Pin	Description	Pin	Description
1	VCC (5V_SB/ 5V)	20	NC
2	USB3.0_RX0-	19	VCC (5V_SB/ 5V)
3	USB3.0_RX0+	18	USB3.0_RX1-
4	Ground	17	USB3.0_RX1+
5	USB3.0_TX0-	16	Ground
6	USB3.0_TX0+	15	USB3.0_TX1-
7	Ground	14	USB3.0_TX1+
8	Data0-	13	Ground
9	Data0+	12	Data1-
10	NC	11	Data1+

JVUSB: 6-pin Power select jumper

Pin	Description
1-3 & 2-4	5V_SB(Default)
3-5 & 4-6	5V

Effective patterns of connection: 1-3 & 2-4 or 3-5 & 4-6

Other may cause damage

JVUSB can control CN_USB3-1 and USB3.0(LEFT) power

USB3.0(RIGHT) have 5V_SB

2.4.6 <Audio interface>

Rear Audio Jack



Line in

Line out

Mic in

CN_AUDIO

2 10



1 9

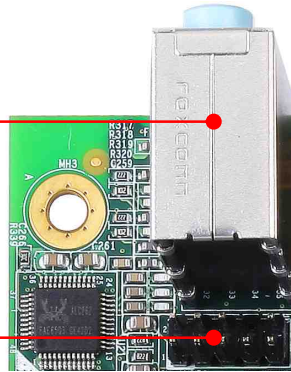

CN_AUDIO: Front panel audio 10-pin header (Pitch 2.54mm)

Pin	Signal	Pin	Signal
1	MIC_L	2	GND
3	MIC_R	4	NC
5	FP_OUT_R	6	MIC_DETECT
7	SENSE	8	Key
9	FP_OUT_L	10	FP_OUT_DETECT

2.4.7 <Expansion slot>

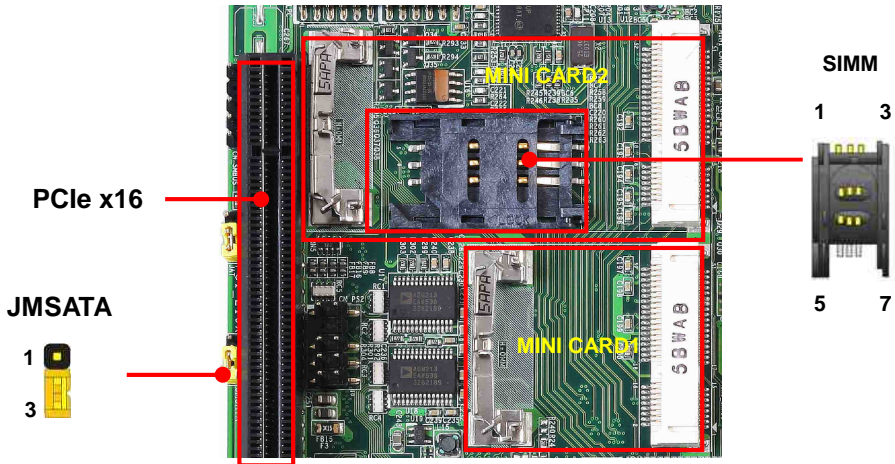

MINI_CARD1 and MINI_CARD2 have some special design to compatible our mini-PCIe card. (ex: MPX-574D2, MPX-210D2 etc)

MINI_CARD2 support mSATA by JMSATA, and connect SIM card with 3G module.

JMSATA: Setting MINI_CARD to support PCIe/mSATA

Jumper settings	Function
1-2	Support mSATA
2-3	Normal operation (Default)

SIMM: (3G MiniPcie Mode)

Pin	Signal	Pin	Signal
1	SIMVCC	2	SIMRST
3	SIMCLK	4	NC
5	GND	6	SIMVPP
7	SIMDATA		

PCIe x16: 164-pin PCIE slot

Use ATX power when you install a graphics card.

2.4.8 <Front panel switch and indicator>

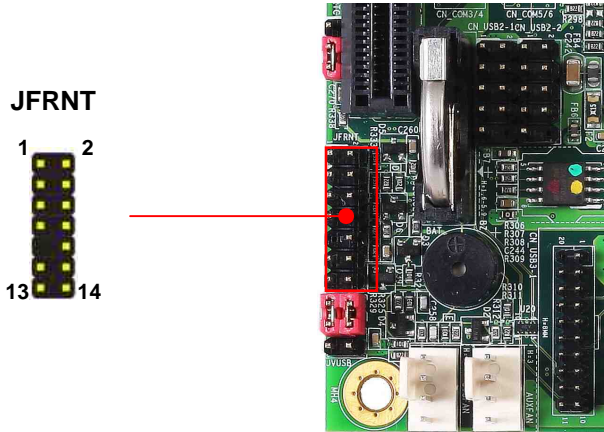

JFRNT: Front panel switch and indicator 14-pin header (Pitch 2.54mm)

Pin	Signal	Pin	Signal
1	HDD_LED+	2	Power_LED+
3	HDD_LED-	4	NC
5	Reset+	6	Power_LED-
7	Reset-	8	Speaker+
9	Key	10	NC
11	Power_ON+	12	NC
13	Power_ON-	14	Speaker-

2.4.9 <GPIO and Other interface>

When using GPIO function, please note:

As Output: **Open-drain**, most applications **need use an external pull up resistor.** (If not may cause damage)

As Input: **TTL-level.**

GPIO DC characteristics

5V TTL-level Input Pin						
Parameter	Sym	Min	Typ	Max	Unit	Conditions
Input Low Threshold Voltage	V_{f-}	0.5	0.8	1.1	V	$V_{CC} = 3.3V$
Input High Threshold Voltage	V_{f+}	1.6	2.0	2.4	V	$V_{CC} = 3.3V$
Hystersis	V_{TH}	0.5	1.2		V	$V_{CC} = 3.3V$
Input High Leakage	I_{LIH}			+10	μA	$V_{IN} = 3.3V$
Input Low Leakage	I_{LIL}			-10	μA	$V_{IN} = 0V$
Open-drain output pin with 12-mA sink capability						
Output Low Voltage	V_{OL}			0.4	V	$I_{OL} = 12\text{ mA}$

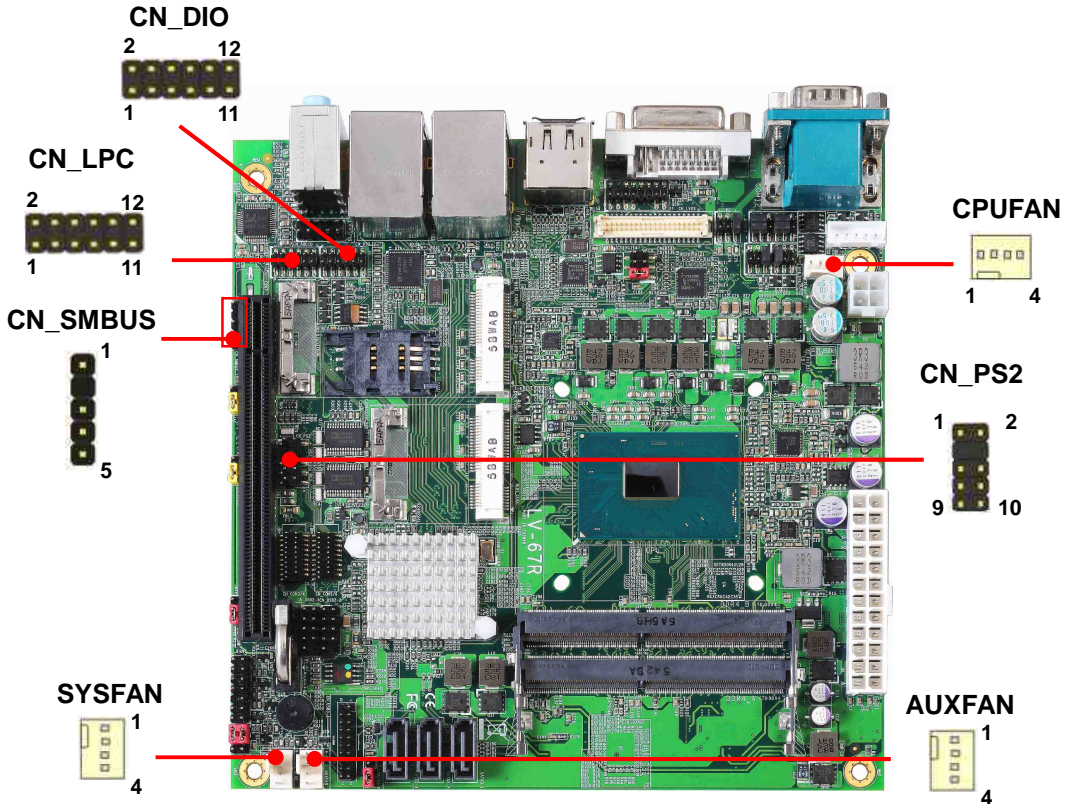

CN_DIO: GPIO 12-pin header (Pitch 2.00mm)

Pin	Signal	Pin	Signal
1	GND	2	GND
3	GPIO0	4	GPIO4
5	GPIO1	6	GPIO5
7	GPIO2	8	GPIO6
9	GPIO3	10	GPIO7
11	5V	12	12V

CN_LPC: LPC 12-pin header (Pitch 2.00mm)

Pin	Signal	Pin	Signal
1	CLK	2	RST
3	-LFRAME	4	LAD3
5	LAD2	6	LAD1
7	LAD0	8	3.3V
9	SERIRQ	10	GND
11	3.3VSB	12	NC

CN_SMBUS: SMBus 5-pin connector (Pitch 2.54mm)

Pin	Signal
1	5V
2	NC
3	SMBDAT
4	SMBCLK
5	GND

CN_PS/2: PS/2 10-pin header (Pitch 2.54mm)

Pin	Signal	Pin	Signal
1	KB_DATA	2	M_DATA
3	NC	4	NC
5	GND	6	GND
7	VCC	8	VCC
9	KB_CLK	10	M_CLK

CPUFAN: CPU cooler fan 4-pin connector

Pin	1	2	3	4
Signal	GND	12V	Sensor	Control

SYSFAN: System cooler fan 4-pin connector

Pin	1	2	3	4
Signal	GND	12V	Sensor	Control

AUXFAN: AUX cooler fan 4-pin connector

Pin	1	2	3	4
Signal	GND	12V	Sensor	Control

2.5 <Power supply>

2.5.1 <Power input>

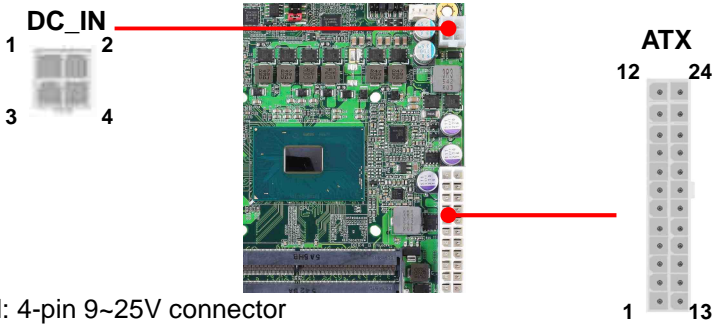

DC_IN: 4-pin 9~25V connector

Pin	Signal	Pin	Signal
1	GND	2	GND
3	9~25V	4	9~25V

ATX: main power 24-pin connector (**DC_IN and ATX can't use at the same time**)

Pin	Signal	Pin	Signal
1	3.3V	13	3.3V
2	3.3V	14	NC
3	GND	15	GND
4	5V	16	-PSON
5	GND	17	GND
6	5V	18	GND
7	GND	19	GND
8	Power_OK	20	NC
9	5VSB	21	5V
10	12V	22	5V
11	12V	23	5V
12	3.3V	24	GND

2.5.1 <Power Output>

It is supply to the HDD, CD-ROM or other device.

If using DC_IN as input, that ATX will be the output.

ATX: main power 24-pin connector (As output)

Pin	Signal	Pin	Signal
1	3.3V	13	3.3V
2	3.3V	14	
3	GND	15	GND
4	5V	16	
5	GND	17	GND
6	5V	18	GND
7	GND	19	GND
8		20	
9		21	5V
10	12V	22	5V
11	12V	23	5V
12	3.3V	24	GND

Appendix A <Flash BIOS>

A.1 <Flash tool>

The board is based on Phoenix BIOS and can be updated easily by the BIOS auto flash tool. You can download the tool online at the address below:

[FPT TOOL](#)

The tool's file name is "fpt.exe", it's the utility that can write the data into the BIOS flash chip and update the BIOS.

A.2 <Flash BIOS process>

1. Please make a bootable UFD which can boot into DOS environment.
2. Unzip the flash tool and copy it into bootable UFD.
3. Add a bin file to the same folder..
4. Power on the system and flash the BIOS under the DOS environment.
(Command: fpt -savemac -f xxx.bin)
5. Power off the system and then power on.

Appendix B <LCD Panel Type select>

According to your panel, it is necessary to select the correct resolution in the BIOS. If there is no fit for your panel type, please provide feedback for us to make an OEM model.

You can find the setting from

[Advanced] → [Intel Advanced Menu]

→ [SA configuration] → [Graphics configuration] → [LCD control]

→ [LCD Panel Type]

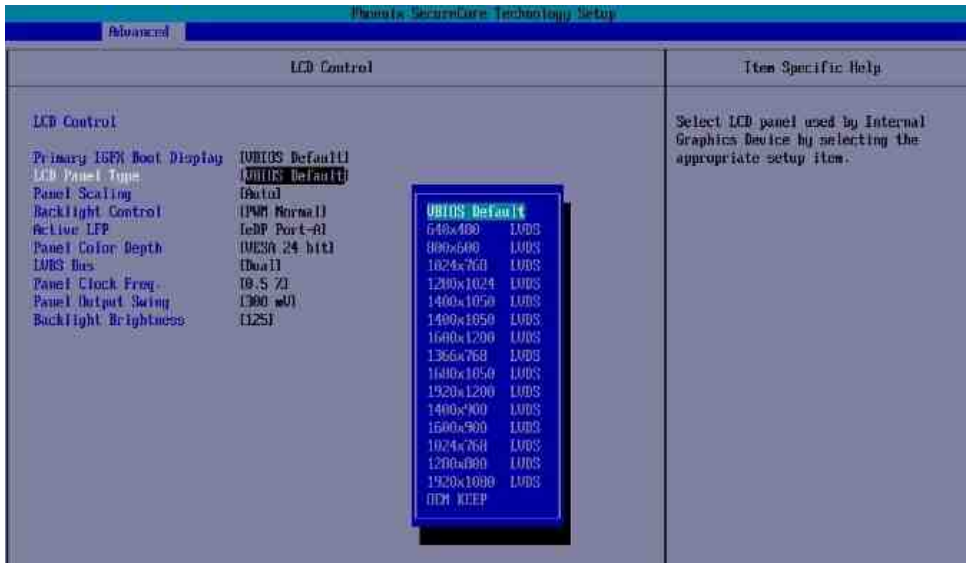

Appendix C <Programmable Watch Dog Timer>

The watchdog timer makes the system auto-reset while it stops to work for a period. The integrated watchdog timer can be setup as system reset mode by program. You can select Timer setting in the BIOS, after setting the time options, the system will reset according to the period of your selection.

Find the setting from

[Advanced] ∪ [Intel Advanced Menu] ∪ [Super IO Chip]

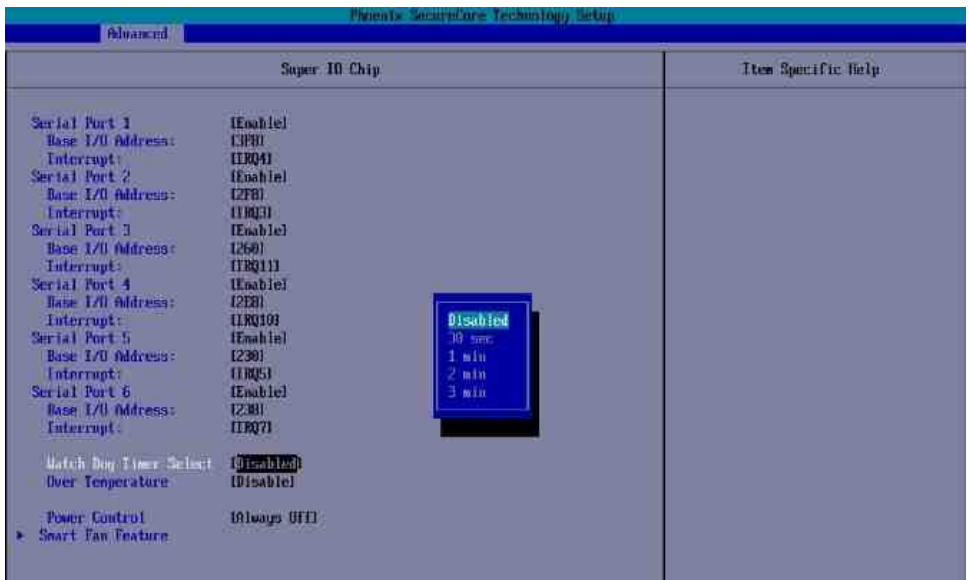

Timeout value range

1 to 255 Minute and Second

Program sample

Watchdog timer setup as system reset with 5 second of timeout

```
-o 4E 87      ;enter configuration
-o 4E 87
-o 4E 07
-o 4F 08      ;select Logical Device
-o 4E 30
-o 4F 01      ; activate WDTO# function
-o 4E F0
-o 4F 00      ;set "00" is second mode, set "08" is minute mode
-o 4E F1
-o 4F 05      ;00h: Timeout Disable
                ;01h: Timeout occurs after 1 minute only
                ;02h: Timeout occurs after 2 second/minute
                ;03h: Timeout occurs after 3 second/minute
                ;
                ;FFh: Timeout occurs after 255 second/minute
                (The deviation is approx 1 second.)
```

For further information, please refer to Nuvoton NCT6106D datasheet

Appendix D <Hardware monitor >

Find the setting from [Misc] U [SIO NCT6106D Hardware Monitor]

Phoenix SecureCore Technology Setup	
Misc	
Hardware Monitor	Item Specific help
System Temperature	128.5 C
CPU Temperature	128.5 C
System Fan Speed	19 RPM
CPU Fan Speed	1909 RPM
AUX Fan Speed	19 RPM
Battery 3V (VINT)	13.056 V
CPU VCCORE	10.568 V
12V	112.724 V
5V	4.888 V

Appendix E <Programmable GPIO >

The GPIO' can be programmed with the MS-DOS debug program using simple IN/OUT commands.

The DC characteristics please refer to GPIO paragraph (Page20).

GPIO	0	1	2	3	4	5	6	7
bit	0	1	2	3	4	5	6	7

-o 4E 87 ;enter configuration

-o 4E 87

-o 4E 07

-o 4F 07 ;select Logical Device

-o 4E 30

-o 4F 10 ;activate GPIO function (The board use GPIO4)

-o 4E F0

-o 4F XX ;set "01" GPIO as input, set "00" GPIO as output

-o 4E F1

-o 4F XX ;if set GPIO as output, this register's value can be set "00~ FF"

Optional

-o 4E F2

-o 4F XX ;set "01", the respective bit are inverted (Both input and output)

;set "00", the respective bit are normal

For further information, please refer to Nuvoton NCT6106D datasheet

Appendix F <RAID Setting>

When use RAID function, it need to enter the BIOS set RAID mode first.

Find the setting from

[Advanced] ú [Intel Advanced Menu] ú [PCH-IO Configuration]
 ú [SATA Configuration] ú [SATA Mode Selection]



SATA And RST Configuration ú Software Feature Mask Configuration
 Set Use RST Legacy OROM ú [Enable]

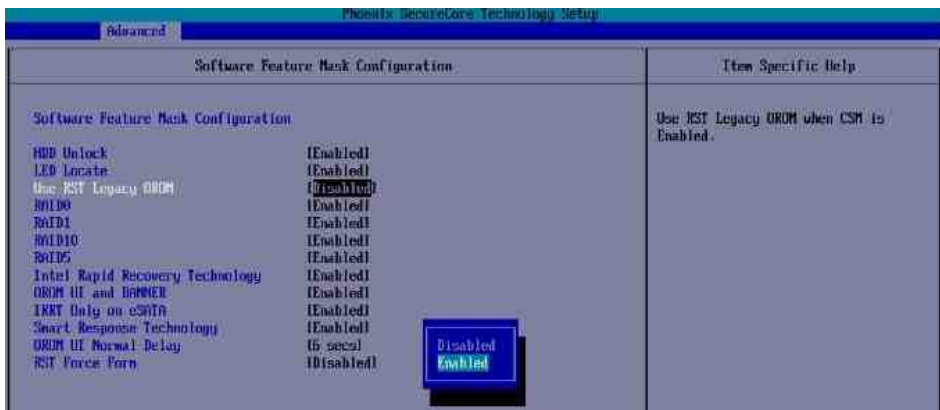

If this screen stop time is too short, it can be set in the BIOS.

[Advanced] ú [Intel Advanced Menu] ú [PCH-IO Configuration]
 ú [SATA Configuration] ú [Software Feature Mask Configuration]
 ú [OROM UI Normal Delay] ú [8 sec] **(Need to set RAID mode first)**

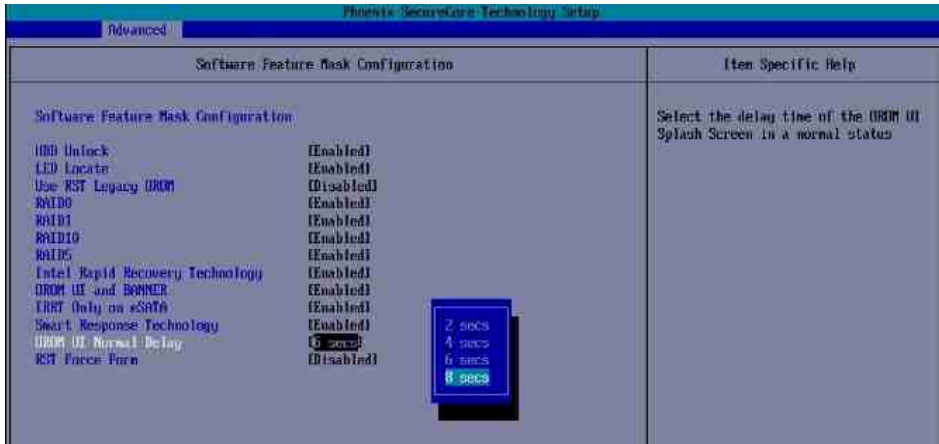

At boot time, press <CTRL + I> to enter the RAID configuration menu.



Appendix G <Setup ADP-3355,ADP-3460>

LV-67RT & LV-67RTK series has a header for 2nd VGA or 2nd LVDS, it's no need install extra driver.

For further information, please refer to the manual.

ADP-3355 manual [Link](#)

ADP-3460 manual [Link](#)

Appendix H <SuperIO Setting>

1. Press DEL to enter BIOS Setup menu.
2. On Advanced screen, Click Intel Advanced Menu



3. On Intel Advanced Menu screen, Click Super IO Chip



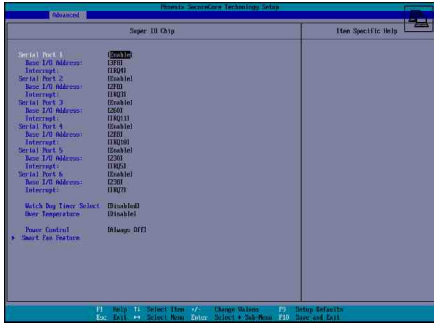

There are 5 functions in the page

1. COM Port control
2. Watch dog timer select
3. Over Temperature

System will restart when CPU Temperature at 60/70/80 Celsius

4. Power control

Restore system when abnormal power condition occurs

[Always Off] keep computer power off after AC power loss recovered.

[Always On] Turn on the computer after AC power loss recovered.

[Former State] System turns off / on when it returns from power-loss state depending on the state before the power loss.

5. Smart Fan

[Manual Mode] Fan will run at full speed.

[Smart FANIV] Fan has different PWM duty cycle in each target temp.

Contact information

Any advice or comment about our products and service, or anything we can help you please don't hesitate to contact with us. We will do our best to support you for your products, projects and business.

Taiwan Commate computer Inc.

Address	19F., NO.94, Sec. 1, Xintai 5 th Rd., Xizhi Dist., New Taipei City 22102, Taiwan.
TEL	+886-2-26963909
FAX	+886-2-26963911
Website	www.commell.com.tw
E-mail	info@commell.com.tw (General information) tech@commell.com.tw (Technical Support)

Commell is a brand name of Taiwan Commate computer Inc.