

MPX-2213

Support IEEE 1394a & 1394b Mini Card

User's Manual

Edition 1.1
2021/01/12



Packing List:

Please check the package content before you starting using the card.

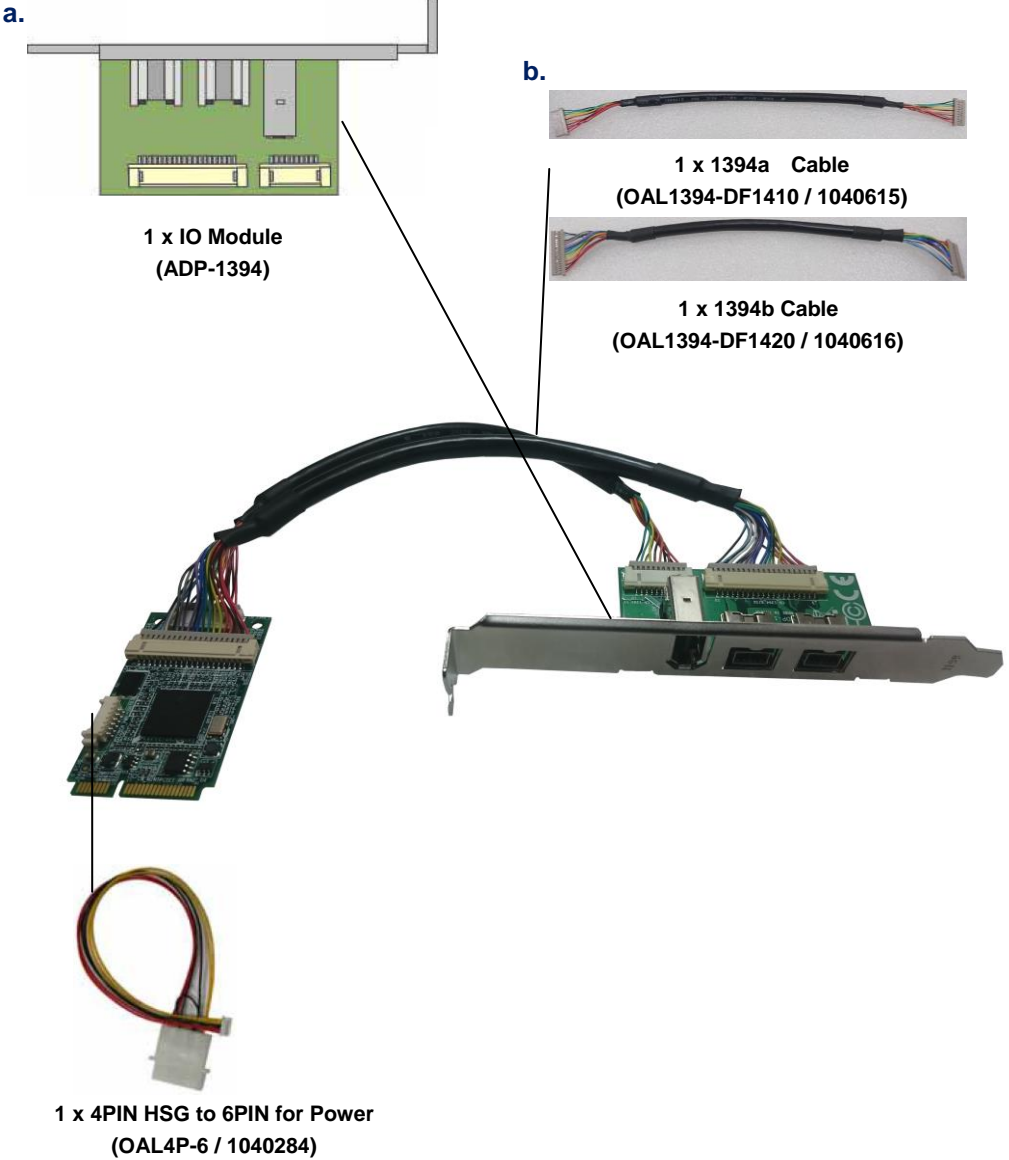

Index

1 <Product Overview>	3
2 <Features>	4
3 <Block Diagram>	5
4 <Product Specifications>	6
4.1 < Recommended Operating Conditions >	7
4.2 < Power Consumption >	7
5 <Pin-out Definition>	8
6 <Component Placement>	10
6.1 < Connector Reference >	10
6.2 < Cable connection >	12
6.3 < Device Manager shows >.....	14
7 <Mechanical Drawing>	15
Contact information	16

1 <Product Overview>

MPX-2213 The 1394b OHCI controller function is fully compatible with IEEE Std 1394b and the latest 1394 Open Host Controller Interface (OHCI) Specification.

MPX-2213 capable of transferring data between the PCIe bus and the 1394 bus at 100M bit/s, 200M bit/s, 400M bit/s, and 800M bit/s.

MPX-2213 provides full PCIe and 1394b functionality and performance.

2 <Features>

- ✧ **Fully Compliant With PCI Express Base Specification, Revision 1.1**

- ✧ **Supports Provisions of IEEE Std P1394b- 2002 and IEEE Std 1394-1995 for IEEE Std 1394a-2000**

- ✧ **Fully Compliant With 1394 Open Host States Controller Interface (OHCI) Specification,Revision 1.1 and Revision 1.2 Draft**

3 <Block Diagram>

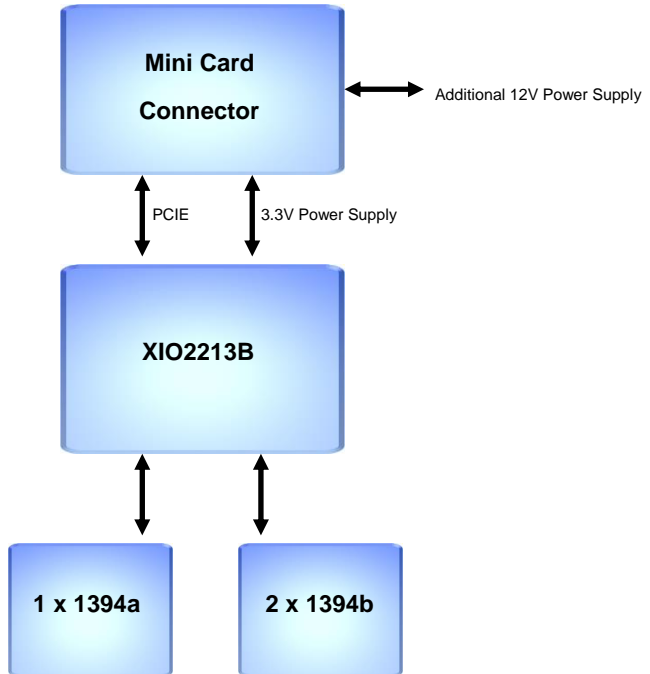

4 <Product Specifications>

Product Description

Host Interface	PCI-E
Controller	XIO2213B
Dimension	30.00mm x 50.95mm
Weight	3g

Operating Conditions

Power Requirement	+3.3V from Mini PCIe +12V from external cable
Temperature	0~70°C
Storage Temperature	-40~+85°C

General Specifications

From factor	Mini-PCI Express with 52-pin interface
Compliance	IEEE 1394a (Firewire 400) x1 IEEE 1394b (Firewire 800) x2
Accessories	1 x IEEE1394 IO module 1 x 10PIN cable for single 1394a (OAL1394-DF1410) 1 x 20PIN cable for dual 1394b (OAL1394-DF1420) 1 x DC input cable (OAL4P-6)
Transfer Rate	100M bits/s, 200M bits/s, 400M bits/s, and 800M bits/s (IEEE 1394b).

4.1 < Recommended Operating Conditions >

Symbol	Parameter	Rating	Unit
Vdd33	I/O voltage	3.135~3.465	V

4.2 < Power Consumption >

Transmitting data	MAX
Power (W)	
1.2	

5 <Pin-out Definition>

Pin No.	Definition	Basic Description	Type
1	NC	Floating Pin, No connect to anything.	
2	3.3V/3.3VAUX	3.3V/3.3VAUX power supply	VCC
3	NC	Floating Pin, No connect to anything.	
4	GND	Ground.	GND
5	NC	Floating Pin, No connect to anything.	
6	1.5V	1.5V	
7	CLKREQ	Reference clock request	
8	NC	Floating Pin, No connect to anything.	
9	GND	Ground.	GND
10	NC	Floating Pin, No connect to anything.	
11	REFCLK-	Differential reference clock.	Input
12	NC	Floating Pin, No connect to anything.	
13	REFCLK+	Differential reference clock.	Input
14	NC	Floating Pin, No connect to anything.	
15	GND	Ground.	GND
16	NC	Floating Pin, No connect to anything.	
17	NC	Floating Pin, No connect to anything.	
18	GND	Ground.	GND
19	NC	Floating Pin, No connect to anything.	
20	NC	Floating Pin, No connect to anything.	
21	GND	Ground.	GND
22	PERST#	PCI express fundamental reset.	Input
23	HSIN0	Differential transmit.	Output
24	3.3VAUX	3.3VAUX power supply.	VCC
25	HSIPO	Differential transmit.	Output
26	GND	Ground.	GND
27	GND	Ground.	GND
28	1.5V	1.5V	
29	GND	Ground.	GND
30	NC	Floating Pin, No connect to anything.	
31	HSON0	Differential receive.	Input
32	NC	Floating Pin, No connect to anything.	
33	HSOP0	Differential receive.	Input

34	GND	Ground.	GND
35	GND	Ground.	GND
36	NC	Floating Pin, No connect to anything.	
37	GND	Ground.	GND
38	NC	Floating Pin, No connect to anything.	
39	3.3VAUX	3.3AUX power supply.	
40	GND	Ground.	GND
41	3.3VAUX	3.3AUX power supply.	
42	NC	Floating Pin, No connect to anything.	
43	GND	Ground.	GND
44	NC	Floating Pin, No connect to anything.	
45	NC	Floating Pin, No connect to anything.	
46	NC	Floating Pin, No connect to anything.	
47	NC	Floating Pin, No connect to anything.	
48	1.5V	1.5V.	
49	NC	Floating Pin, No connect to anything.	
50	GND	Ground.	GND
51	NC	Floating Pin, No connect to anything.	
52	3.3V/3.3AUX	3.3V/3.3AUX power supply	VCC

6 <Component Placement>

6.1 < Connector Reference >

MPX-2213:

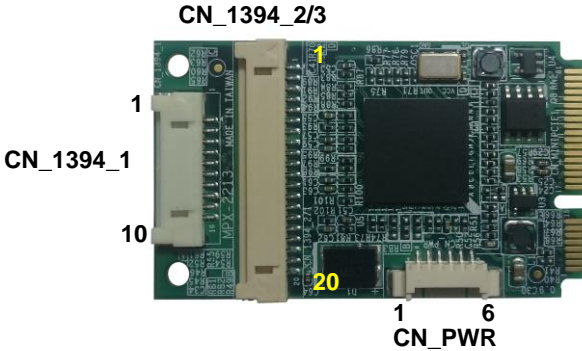

Connector: CN_PWR

Connector Type:

1252 6-Pin , pitch : 1.25 mm

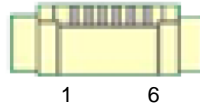

Pin	Description(LAN1)	Pin	Description(LAN2)
1	+12V	2	+12V
3	GND	4	GND
5	NC	6	NC

Connector: CN_1394_1

Connector Type:

DF14 10-Pin , pitch : 1.25 mm

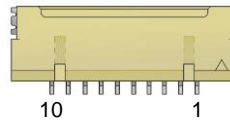

Pin	Description(LAN1)	Pin	Description(LAN2)
1	TPB0-	2	TPB0+
3	GND	4	TPA0-
5	TPA0+	6	NC
7	GND	8	PWR(+12V)
9	GND	10	GND

Connector: CN_1394_2/3
Connector Type:

DF14 20-Pin , pitch : 1.25 mm

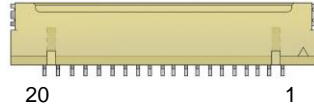

Pin	Description(LAN1)	Pin	Description(LAN2)
1	TPB1-	2	TPB1+
3	GND	4	TPA1-
5	TPA1+	6	NC
7	GND	8	PWR(+12V)
9	GND	10	GND
11	TPB2-	12	TPB2+
13	GND	14	TPA2-
15	TPA2+	16	NC
17	GND	18	PWR(+12V)
19	GND	20	GND

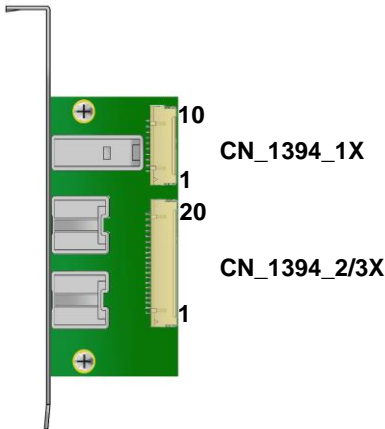
Connector: CN_1394_1X
Connector Type:

DF14 10-Pin , pitch : 1.25 mm

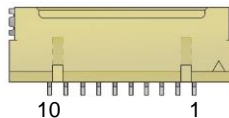

Pin	Description(LAN1)	Pin	Description(LAN2)
1	TPB0-	2	TPB0+
3	GND	4	TPA0-
5	TPA0+	6	NC
7	GND	8	PWR(+12V)
9	GND	10	GND

Connector: CN_1394_2/3X
Connector Type:

DF14 20-Pin , pitch : 1.25 mm

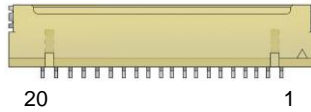

Pin	Description(LAN1)	Pin	Description(LAN2)
1	TPB1-	2	TPB1+
3	GND	4	TPA1-
5	TPA1+	6	NC
7	GND	8	PWR(+12V)
9	GND	10	GND
11	TPB2-	12	TPB2+
13	GND	14	TPA2-
15	TPA2+	16	NC
17	GND	18	PWR(+12V)
19	GND	20	GND

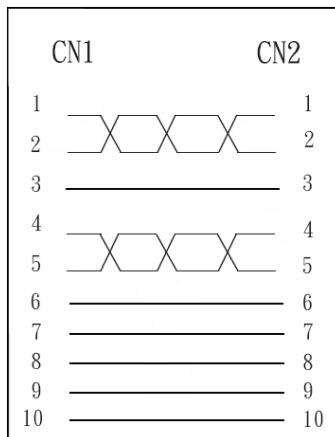
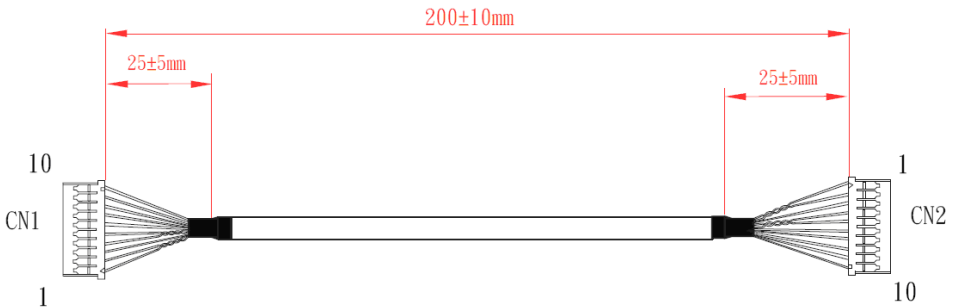
6.2 < Cable connection >

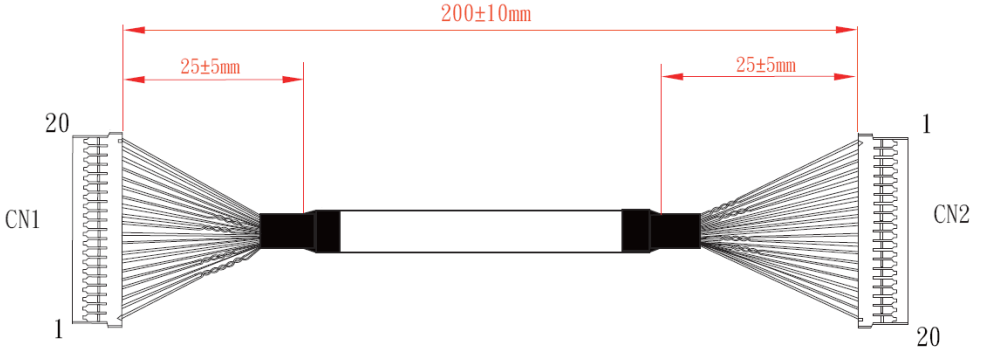

CN1	CN2	CN1	CN2
1	1	11	11
2	2	12	12
3	3	13	13
4	4	14	14
5	5	15	15
6	6	16	16
7	7	17	17
8	8	18	18
9	9	19	19
10	10	20	20

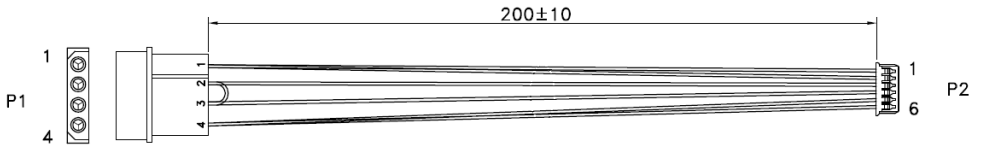

PIN OUT:

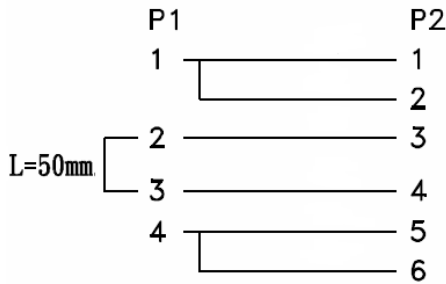

6.3 < Device Manager shows >

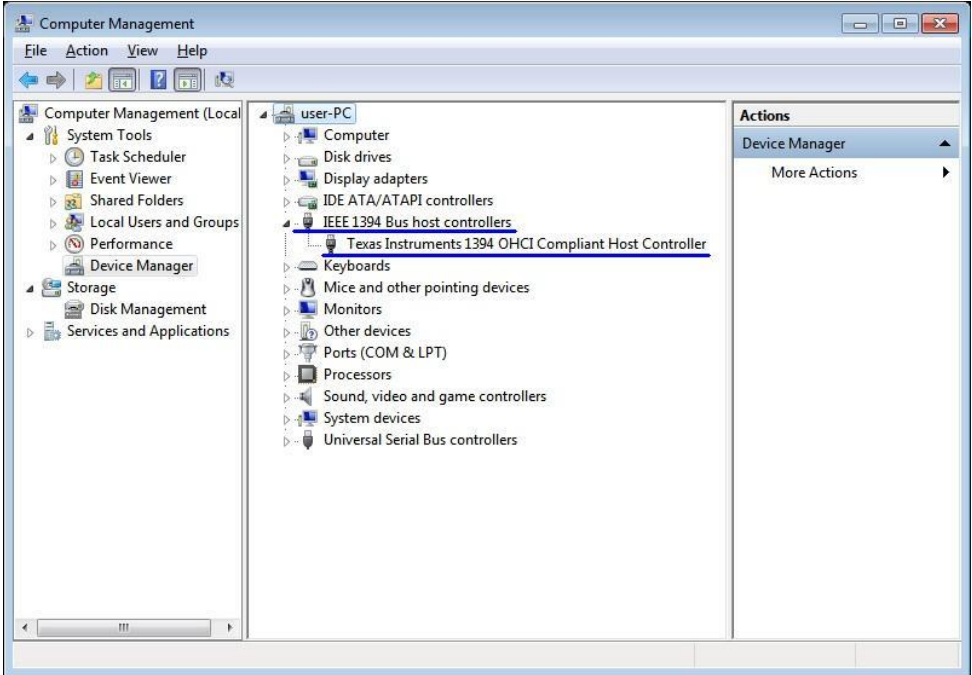

Contact information

Any advice or comment about our products and service, or anything we can help you please don't hesitate to contact with us. We will do our best to support you for your products, projects and business.

Taiwan Commate computer Inc.

Address	19F., NO.94, Sec. 1, Xintai 5 th Rd., Xizhi Dist., New Taipei City 22102, Taiwan.
TEL	+886-2-26963909
FAX	+886-2-26963911
Website	www.commell.com.tw
E-mail	info@commell.com.tw (General information) tech@commell.com.tw (Technical Support)